

# Chinese Learning Cards for HSK

## HSK 汉字学习卡片



# Chinese Learning Cards for HSK

汉字学习卡片

Compiler: Sun Tao

编者：孙涛

Morning Glory Publishers

 朝華出版社

图书在版编目(CIP)数据

HSK汉字学习卡片/孙涛主编 — 北京:朝华出版社,  
2005.7

ISBN 7-5054-1310-4

I. H… II. 孙… III. 汉字 — 对外汉语教学 — 水平  
考试 — 自学参考资料 IV. 195.4

中国版本图书馆CIP数据核字(2005)第075235号

责任编辑 顾 珺  
英文编辑 顾 珺  
封面设计 褚黎丽  
责任印制 赵 岭

孙涛 主编

©朝华出版社

朝华出版社出版

(中国北京车公庄西路35号)

邮政编码 100044

北京盛兰兄弟印刷装订有限公司印刷

中国国际图书贸易总公司发行

(中国北京车公庄西路35号)

北京邮政信箱第399号 邮政编码 100044

2005年9月(正16开)第1版

2005年9月第1版第1次印刷

(汉英)

03800

Compiler: Sun Tao

编者: 孙涛

Translator: Wu Chengdong

Editor: Gu Jun

Cover Designer: Lily Chu

First Edition 2005

Chinese Learning Cards for HSK

Key Words for HSK

ISBN 7-5054-1310-4

©Morning Glory Publishers

Published by Morning Glory Publishers

35 Chegongzhuang Xilu, Beijing 100044, China

E-mail: gujun@mail.cibtc.com.cn

Distributed by China International Book Trading Corporation

35 Chegongzhuang Xilu, Beijing 100044, China

Printed in the People's Republic of China

# Preface

HSK is a national standard test for testing the Chinese language level of foreigners, overseas Chinese, ethnic minority people and others whose mother tongue is not Chinese. HSK includes basic Chinese language level, elementary and intermediate Chinese language level, and advanced Chinese language level tests designed by Chinese Language Test Center of Beijing Language and Cultural University. HSK holds regular test at home and abroad, and one will be issued with the "Chinese Language Level Certificate" when having passed the test.

The National Chinese Language Level Test Committee, affiliated to the Ministry of Education of China, is empowered to sponsor the test and issue the examination certificate. Under the National Chinese Language Level Test Committee is an office charged with the work related to the test. The basic Chinese language test is organized for those who have studied modern Chinese language in schools for 100 to 800 hours. The elementary and intermediate Chinese language test is for those who have studied modern Chinese language in schools for 400 to 2000 hours. The advanced Chinese language test is for those who have studied modern Chinese language in schools for 3000 or more than 2000 hours. HSK is a real Chinese language level certificate for those students who make specialistic study in China's institutes or universities, or apply for their graduate study. People holding the HSK certificates shall be exempt from the compulsory test required to test the given Chinese language level.

This book is compiled in accordance with the requirements of HSK. It contains all Chinese characters indispensable for basic, elementary and intermediate and advanced Chinese language level tests. It is completed with the order of strokes, pinyin, related phrases and English translation of each character. For the convenience of the readers, each page of the book is printed in the shape of post stamps. This is designed to facilitate readers who wish to tear pages off the book for reading purpose.

Recent years have seen an increasing number of people in the world who are studying Chinese language. The Chinese language books sell well as a result. Under the situation, the Chinese language teaching and publication of the Chinese language books see constant improvement made to meet the need of the market. The Morning Glory Publishers undertakes to publish the Chinese language books, and will work to provide special and overall service to our readers. Foreign cooperation in this regard is anticipated to benefit our readers.

# 前 言

中国汉语水平考试(HSK)是为测试母语非汉语者(包括外国人、华侨和中国国内少数民族人员)的汉语水平而设立的国家级标准化考试。中国汉语水平考试(HSK)由北京语言文化大学汉语水平考试中心设计研制,包括基础汉语水平考试〔简称为HSK(基础)〕、初、中等汉语水平考试〔简称为HSK(初、中等)〕和高等汉语水平考试〔简称为HSK(高等)〕。中国汉语水平考试(HSK)每年定期在中国国内和海外举办,凡考试成绩达到规定标准者,可获得相应等级的《汉语水平证书》。

中国教育部设立国家汉语水平考试委员会,该委员会全权领导汉语水平考试,并颁发汉语水平证书。委员会下设办公室,称国家汉语水平考试委员会办公室,负责HSK的考务工作。HSK(基础)适用于具有基础汉语水平的汉语学习者,也就是接受过100~800学时现代汉语正规教育的学习者(包括具有同等学力者)。HSK(初、中等)适用于具有初等和中等汉语水平的汉语学习者,也就是接受过400~2000学时现代汉语正规教育的学习者(包括具有同等学力者)。HSK(高等)适用于具有高等汉语水平的汉语学习者,也就是接受过3000学时和3000学时以上的现代汉语正规教育的学习者(包括具有同等学力者)。中国汉语水平考试(HSK)也可作为达到进中国高等院校入系学习专业或报考研究生所要求的实际汉语水平的证明,作为汉语水平达到某种等级或免修相应级别汉语课程的证明和作为聘用机构录用汉语人员的依据。

《汉字学习卡片》正是根据中国汉语水平考试(HSK)的要求,汇编了基础汉语水平考试〔简称为HSK(基础)〕、初、中等汉语水平考试〔简称为HSK(初、中等)〕和高等汉语水平考试〔简称为HSK(高等)〕的全部汉字。并根据母语非汉语者(包括外国人、华侨和中国国内少数民族人员)的特点,对汉字的笔画顺序、拼音、词组、英语解释等进行了标注。为了帮助学习者更好地学习使用汉字,本书在装帧形式上采用了邮票印制形式(既可以按图书方式阅读,也可以撕下后形成卡片),每个汉字的背面就是其相关词组与解释。

近几年来,汉语学习的热潮正在兴起,有关汉语学习的图书越来越多地受到读者的欢迎。汉语的教学、出版工作也不断创新以适应市场的需求。朝华出版社作为中国出版界对外出版的窗口,肩负着汉语学习与交流的重任,我们将不断地为我们的读者提供更专业、更全面的出版服务,也期待着更多的朋友成为我们的读者;期待着更多的国外出版商与我们合作,共同开发汉语学习与出版的市场,使更多的读者从中受益。

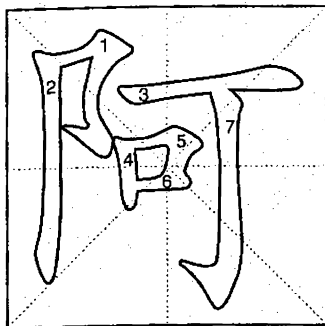

阿 ā 1

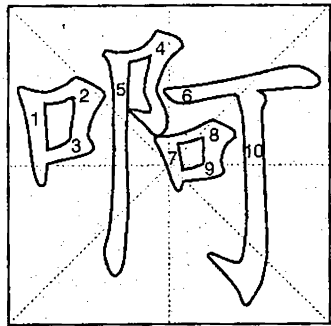

啊 ā 2

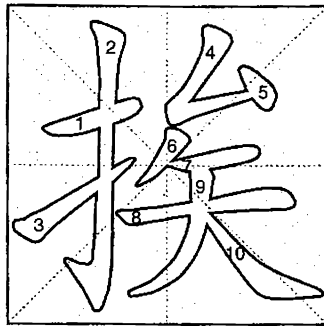

挨 āi 3

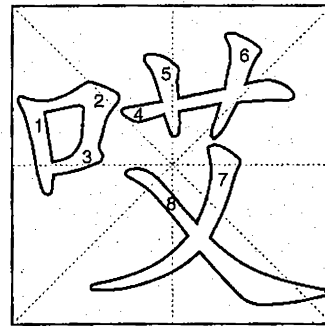

哎 āi 4

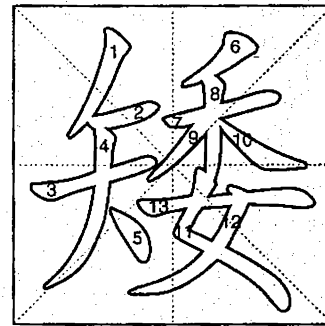

矮 ǎi 5

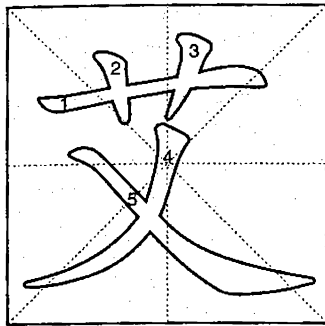

艾 ài 6

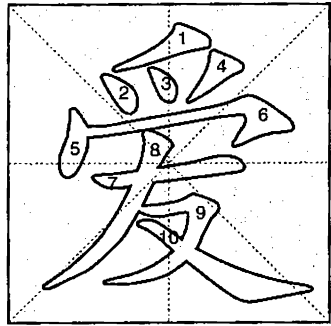

爱 ài 7

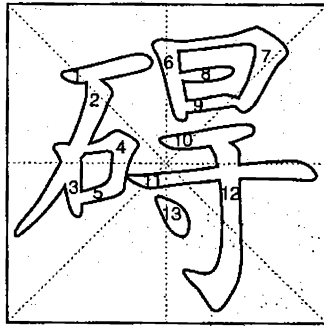

碍 ài 8

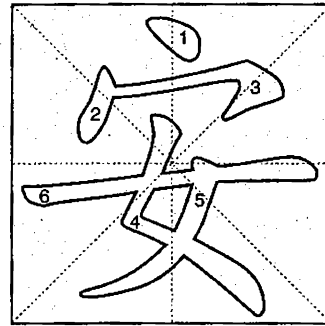

安 ān 9

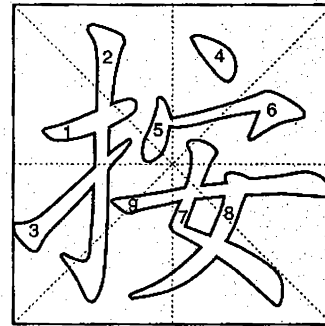

按 àn 10

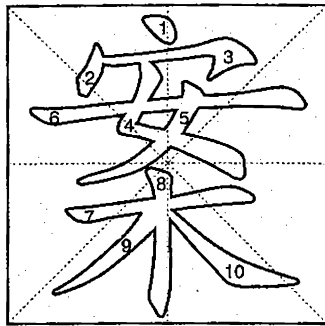

案 àn 11

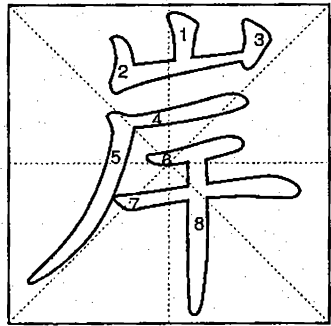

岸 àn 12

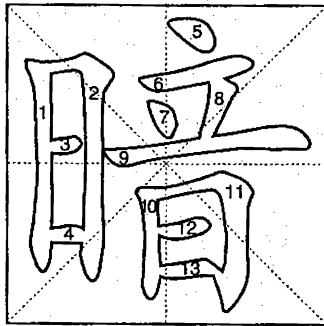

暗 àn 13

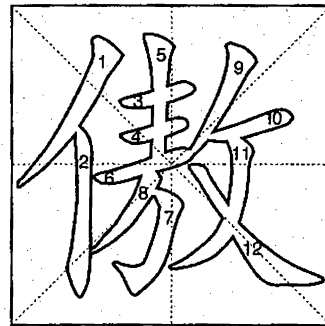

傲 ào 14

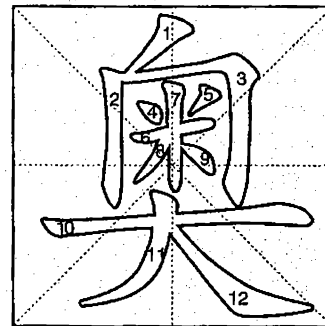

奥 ào 15

**矮 āi**

short

矮个儿 āi'gè'r

a short person

矮胖 āi'pàng

roly-poly

矮小 āi'xiǎo

short and small

**哎 āi**

hey; ah

哎哟 āi'yō

ouch; ow

**挨 āi**

be next to; get close to; by turns

挨边 āi'biān

keep close to the edge

挨近 āi'jìn

be near to; get close to

挨着 āi'zhe

close to

**阿 ā**

eh; oh; o; ah; hey

**阿 ā**

阿拉伯 ā'lā'bó

Arabian; Arabic; Arab

阿司匹林〈药〉 ā'sī'pí'lin(yào)

aspirin

阿姨〈对母辈的称呼〉

ā'yí〈duì'mǔ'bèi'de'chēng'hu〉

auntie; aunt

**按 àn**

①press; push down; put hand on

②according to; in the light of

按摩 àn'mó

massage

按期〈时〉 àn'qī(shí)

on time; on schedule

按照 àn'zhào

according to

**安 ān**

peaceful; quiet; calm

安插 ān'chā

get a position for sb.

安定 ān'dìng

stable; settled

安顿 ān'dùn

find a place for

**碍 ài**

hinder; obstruct;

be in the way of

碍事 ài'shì

be a hindrance; matter

碍手碍脚 ài'shǒu'ài'jiǎo

be in the way; be a hindrance

**爱 ài**

be apt to; love

爱好 ài'hào

love; like; be fond of

爱护 ài'hù

take good care of; cherish

爱恋 ài'liàn

fall in love with

**艾 ài**

argy wormwood

艾滋病 ài'zī'bìng

AIDS (Acquired Immune  
Deficiency Syndrome)**奥 ào**

profound; abstruse

奥林匹克运动会

ào'lín'pǐ'kè'yùn'dòng'huì

The Olympic Games

奥秘 ào'mì

mystery

奥斯卡金像奖

ào'sī'kā'jīn'xiàng'jiǎng

Oscar

**傲 ào**

proud; haughty

傲慢 ào'màn

arrogant

傲气 ào'qì

haughtiness

**暗 àn**

dark; dim

暗恋 àn'liàn

love sb. in one's heart

暗码 àn'mǎ

secret code; private mark

暗示 àn'shì

suggest; hint; drop a hint

**岸 àn**

bank; shore; coast

岸边 àn'biān

shoreside

**案 àn**

table; desk

案板 àn'bǎn

kitchen chopping board

案件 àn'jiàn

law case, legal case

案例 àn'lì

case; example of case

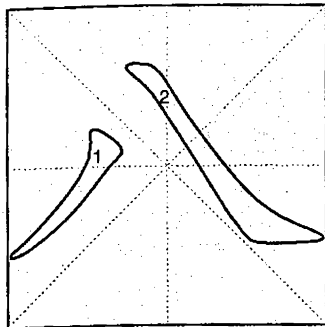

八 bā 16

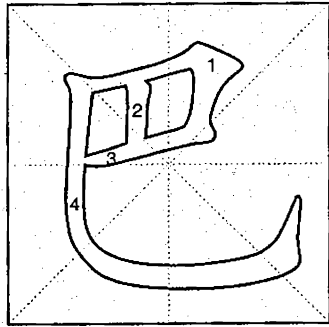

巴 bā 17

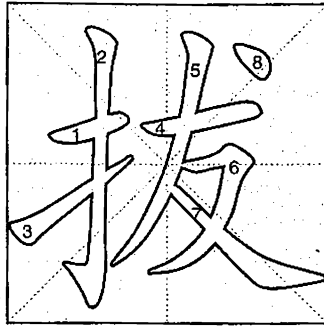

拔 bá 18

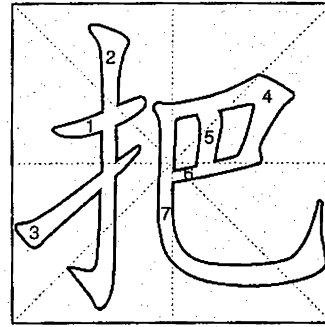

把 bǎ 19

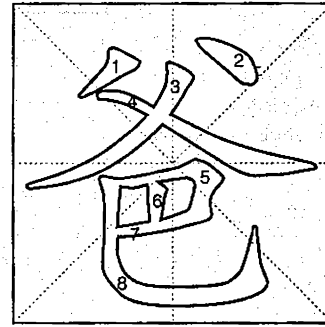

爸 bà 20

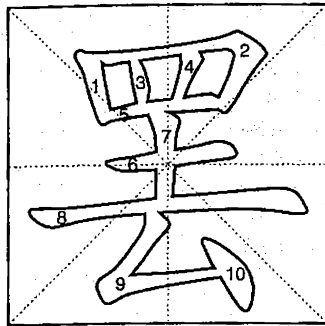

罢 bà 21

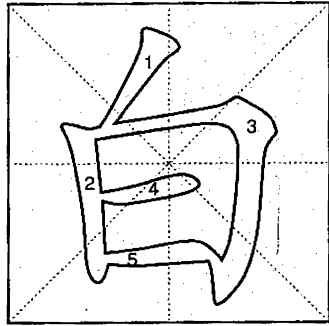

白 bái 22

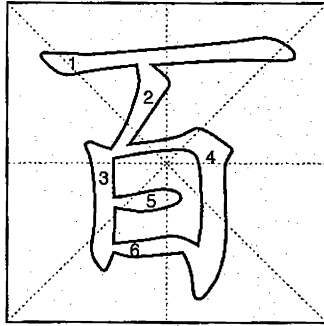

百 bǎi 23

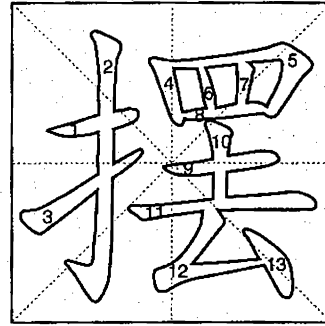

摆 bǎi 24

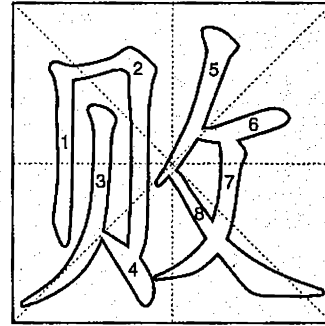

败 bài 25

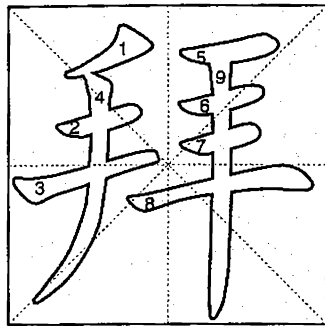

拜 bài 26

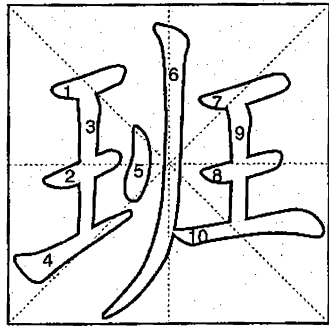

班 bān 27

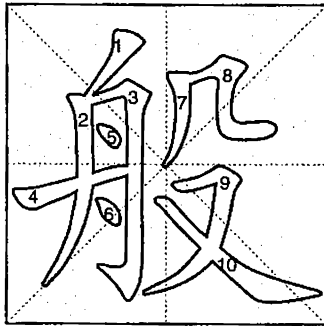

般 bān 28

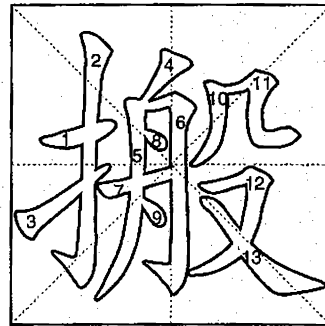

搬 bān 29

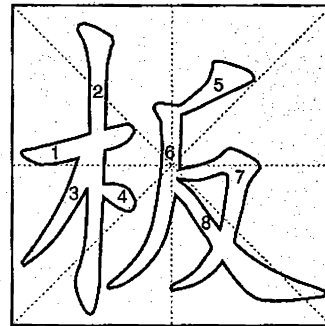

板 bǎn 30



**爸 bà**

pa; dad; father  
 爸爸 bà'ba  
 papa; dad; father

**把 bǎ**

hold; grasp  
 把柄 bǎ'bǐng  
 handle; fault; weakness  
 把门 bǎ'mén  
 guard a gate  
 把手 bǎ'shǒu  
 handle; grip; knob

**拔 bá**

pull out; pull up  
 拔草 bá'cǎo  
 pull up weeds  
 拔河〈体〉 bá'hé〈y〉  
 tug-of-war  
 拔牙 bá'yá  
 draw one's teeth

**巴 bā**

巴结 bā'jie  
 fawn on; curry favour with  
 巴士 bā'shì  
 bus  
 巴掌 bā'zhang  
 palm; hand

**八 bā**

eight  
 八宝饭 bā'bǎo'fàn  
 eight-treasure rice pudding  
 八月 bā'yue  
 August  
 八折 bā'zhé  
 twenty percent discount

**败 bài**

be defeated; lose  
 败局 bài'jú  
 lost game; losing battle  
 败露 bài'lù  
 be discovered or exposed  
 败诉 bài'sù  
 lose a lawsuit

**摆 bǎi**

put; place  
 摆动 bǎi'dòng  
 swing; sway  
 摆渡 bǎi'dù  
 ferry  
 摆脱 bǎi'tuō  
 cast off; shake off

**百 bǎi**

hundred  
 百分比 bǎi'fēn'bǐ  
 percentage  
 百万 bǎi'wàn  
 million--富翁(fù'wēng) million-  
 aire  
 百叶窗 bǎi'yè'chuāng  
 shutter; blind; jalousie

**白 bái**

white  
 白皮书 bái'pí'shū  
 white paper; white book  
 白色 bái'sè  
 white colour; white (as a symbol  
 of reaction)  
 白天 bái'tiān  
 daytime; day

**罢 bà**

stop; finish  
 罢工 bà'gōng  
 strike; go on strike  
 罢免 bà'miǎn  
 recall  
 罢手 bà'shǒu  
 give up

**板 bǎn**

board; plank; plate  
 板材 bǎn'cái  
 board; plates  
 板凳 bǎn'dèng  
 wooden bench or stool  
 板刷 bǎn'shuā  
 scrubbing brush

**搬 bān**

take away  
 搬家 bān'jiā  
 move (house)  
 搬迁 bān'qiān  
 move from one place to another  
 搬运 bān'yùn  
 carry; transport

**般 bān**

sort; kind; way  
 般配 bān'pèi  
 be well matched

**班 bān**

class; team  
 班房 bān'fáng  
 jail  
 班机 bān'jī  
 airliner; scheduled flight  
 班级 bān'jí  
 classes and grades in school

**拜 bài**

do obeisance  
 拜访 bài'fǎng  
 pay a visit; call on  
 拜年 bài'nián  
 pay a New Year call  
 拜师 bài'shī  
 take sb. as one's teacher

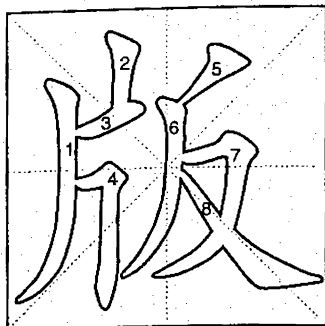

版 bǎn 31

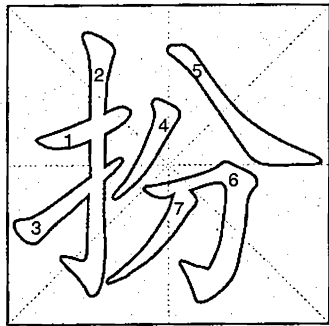

扮 bàn 32

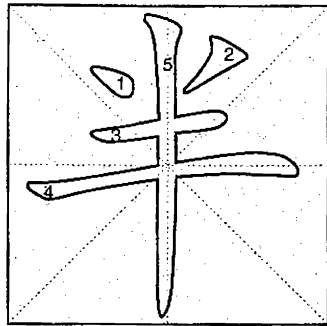

半 bàn 33

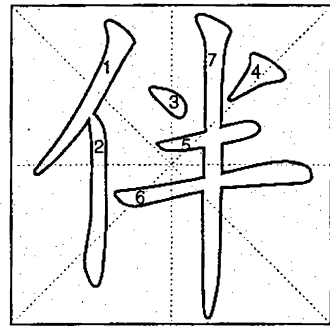

伴 bàn 34

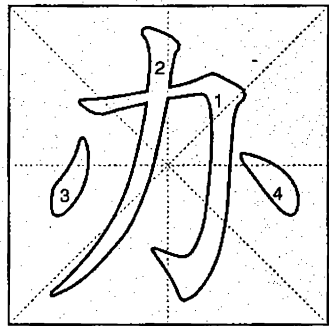

办 bàn 35

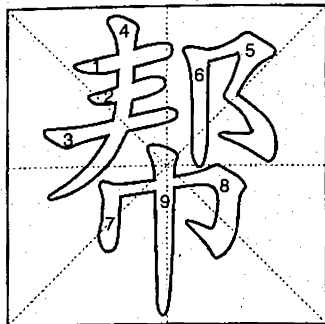

帮 bāng 36

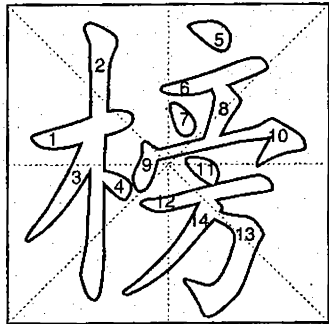

榜 bǎng 37

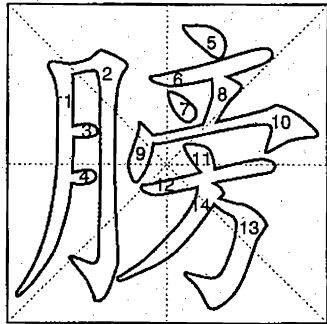

膀 bǎng 38

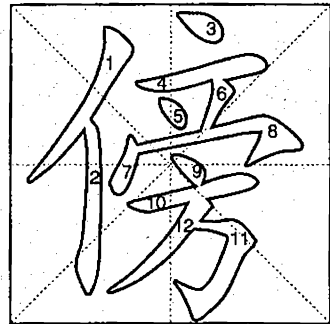

傍 bàng 39

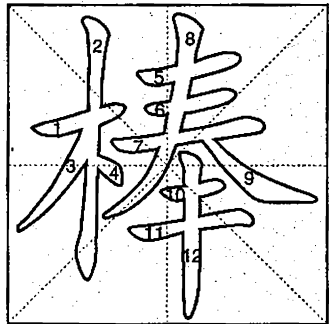

棒 bàng 40

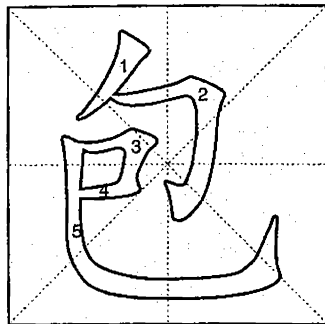

包 bāo 41

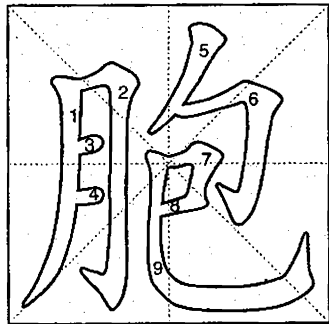

胞 bāo 42

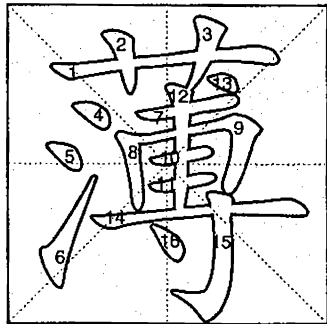

薄 báo 43

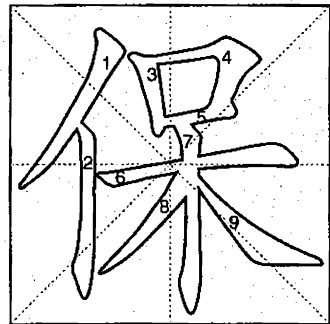

保 bǎo 44

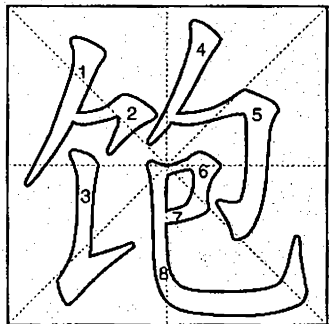

饱 bǎo 45

**办 bàn**

do; handle; manage; tackle; attend to

办案 bàn'àn

handle a case

办法 bàn'fǎ

way; means; method

办公室 bàn'gōngshì

office

**伴 bàn**

companion; partner

伴侣 bàn'lǚ

companion; mate; partner

伴随 bàn'suí

accompany; follow

伴奏 bàn'zòu

accompany (with musical instruments)

**半 bàn**

half; semi

半价 bàn'jià

(at) half price

半旗 bàn'qí

half-mast

半夜 bàn'yè

midnight

**扮 bàn**

be dressed up as

扮相 bàn'xiàng

the makeup of an actor

扮演 bàn'yǎn

play the part of; act

扮装 bàn'zhuāng

makeup

**版 bǎn**

printing plate

版本 bǎn'běn

edition

版权 bǎn'quán

copyright

版税 bǎn'shuì

royalty (on books)

**棒 bàng**

stick; club

棒槌 bàng'chuí

wooden club

棒球 bàng'qiú

baseball

棒子 bàng'zi

stick; club; cudgel

**傍 bàng**

draw near

傍晚 bàng'wǎn

toward evening; at dusk

**膀 bǎng**

upper arm

膀子 bǎng'zi

upper arm; arm

**榜 bǎng**

announcement

榜样 bǎng'yàng

good example; model

**帮 bāng**

help; assist

帮忙 bāng'máng

help; give a hand

帮手 bāng'shǒu

helper; assistant

帮助 bāng'zhù

help; give a hand to

**饱 bǎo**

have eaten one's fill; be full

饱和 bǎo'hé

saturation

饱满 bǎo'mǎn

full; plump

饱学 bǎo'xué

learned; erudite

**保 bǎo**

protect; defend; keep; maintain;

preserve

保镖 bǎo'biāo

bodyguard

保释 bǎo'shì

release on bail; bail

保险 bǎo'xiǎn

insurance

**薄 báo**

thin

薄饼 báo'bǐng

thin pancake

薄壳 báo'ké

shell

薄纸 báo'zhǐ

tissue paper

**胞 bāo**

①afterbirth

②born of the same parents

胞兄弟 bāo'xiōng'dì

blood brothers

胞衣 bāo'yī

afterbirth

**包 bāo**

wrap; bag; swelling

包括 bāo'kuò

include; consist of

包销 bāo'xiāo

have exclusive selling rights

包装 bāo'zhuāng

pack; package

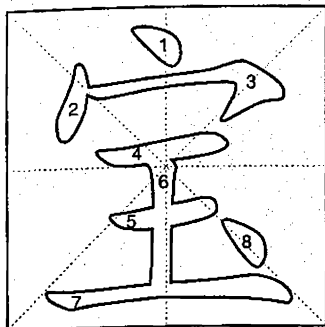

宝 bǎo 46

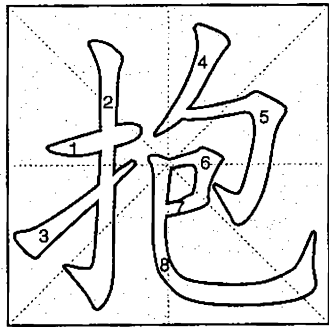

抱 bào 47

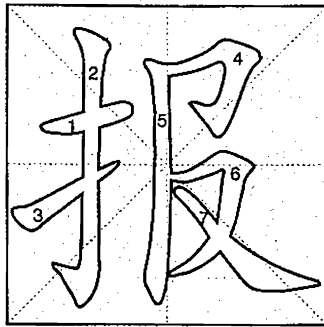

报 bào 48

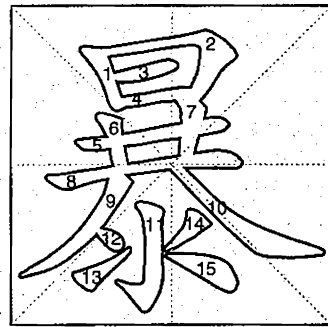

暴 bào 49

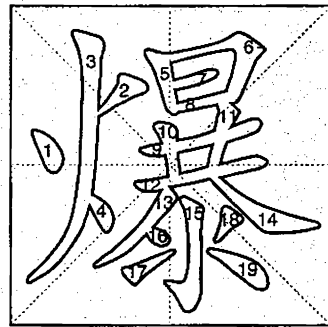

爆 bào 50

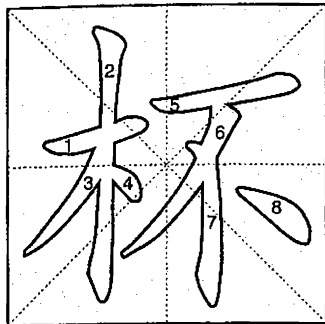

杯 bēi 51

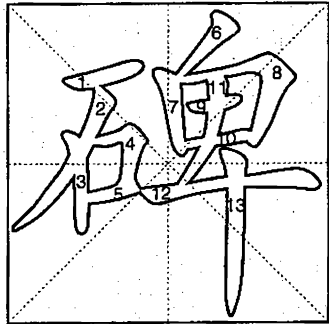

碑 bēi 52

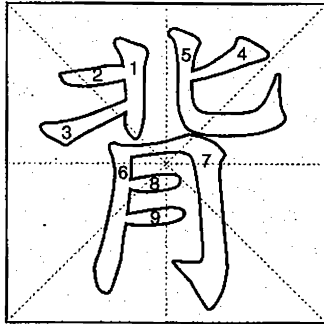

背 bēi 53

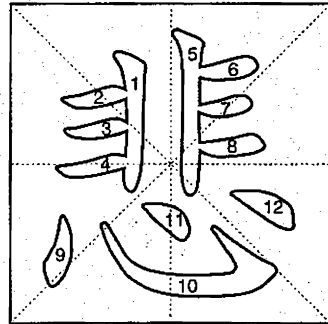

悲 bēi 54

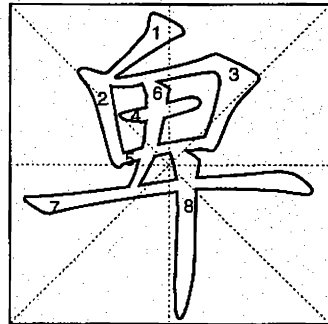

卑 bēi 55

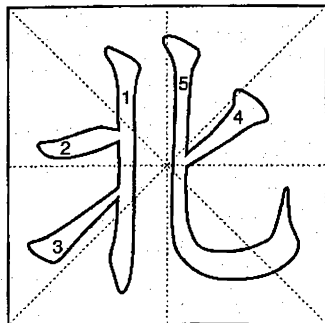

北 běi 56

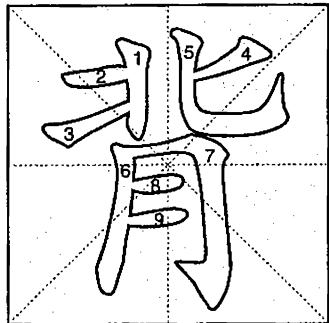

背 bèi 57

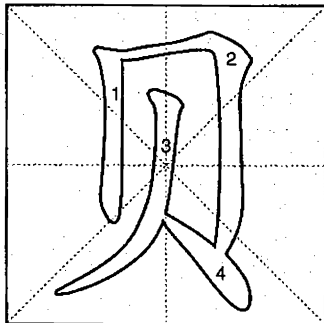

贝 bèi 58

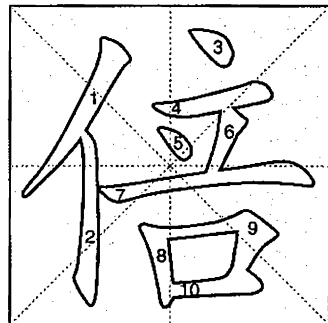

倍 bèi 59

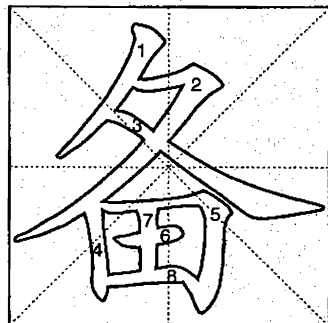

备 bèi 60

**爆 bào**

explode; burst; quick-fry  
 爆发 bào'fā  
 erupt; burst out  
 爆冷门 bào'lěng'mén  
 be a surprise  
 爆满 bào'mǎn  
 overflowing audience

**暴 bào**

sudden and violent; cruel; savage; hot-tempered  
 暴风雪 bào'fēng'xuě  
 snowstorm; blizzard  
 暴力 bào'lì  
 violence; force  
 暴雨 bào'yǔ  
 torrential rain; rainstorm

**报 bào**

report; reply; newspaper  
 报关 bào'guān  
 apply to customs  
 报价 bào'jià  
 offer; quote; offering  
 报刊 bào'kān  
 newspapers and periodicals

**抱 bào**

hold or carry in the arms; embrace; hug  
 抱病 bào'bìng  
 be ill; be in bad health  
 抱歉 bào'qiàn  
 be sorry; feel apologetic  
 抱养 bào'yǎng  
 adopt (a child)

**宝 bǎo**

treasure  
 宝贝 bǎo'bèi  
 darling; baby  
 宝石 bǎo'shí  
 precious stone; gem  
 宝塔 bǎo'tǎ  
 pagoda

**卑 bēi**

low; inferior; modest; humble  
 卑鄙 bēi'bǐ  
 base; amoral  
 卑贱 bēi'jiàn  
 lowly; mean and low  
 卑劣 bēi'liè  
 base; mean; despicable

**悲 bēi**

sad; melancholy; compassion  
 悲剧 bēi'jù  
 tragedy  
 悲伤 bēi'shāng  
 sad; sorrowful  
 悲痛 bēi'tòng  
 grieved; sorrowful

**背 bēi**

carry on the back  
 背带 bēi'dài  
 braces; sling  
 背负 bēi'fù  
 bear; carry on the back  
 背债 bēi'zhài  
 be in debt

**碑 bēi**

stone tablet; stele  
 碑文 bēi'wén  
 an inscription on a tablet

**杯 bēi**

cup; glass  
 杯中物 bēi'zhōng'wù  
 alcoholic drink  
 杯子 bēi'zi  
 cup; glass

**备 bèi**

be equipped with; have  
 备案 bèi'àn  
 put on record (on file)  
 备份 bèi'fēn  
 backup  
 备注 bèi'zhù  
 remarks

**倍 bèi**

times; -fold; double  
 倍加 bèi'jiā  
 extraordinarily; extremely  
 倍数(数) bèi'shù(shù)  
 multiple  
 倍增 bèi'zēng  
 double; redouble

**贝 bèi**

shellfish; cowrie  
 贝雕 bèi'diāo  
 shell carving  
 贝壳 bèi'ké  
 shell

**背 bèi**

the back of the body  
 背包 bèi'bāo  
 backpack; packsack  
 背景 bèi'jǐng  
 background; backdrop  
 背诵 bèi'sòng  
 recite; repeat from memory

**北 běi**

north  
 北冰洋 běi'bīng'yáng  
 The Arctic Ocean  
 北方 běi'fāng  
 north  
 北极 běi'jí  
 The North Pole

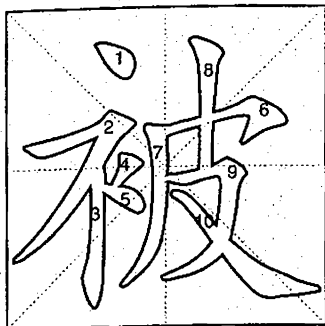

被 bèi 61



奔 bēn 62

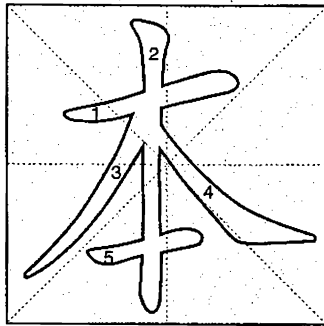

本 běn 63

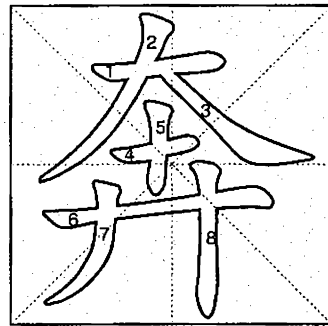

奔 bèn 64

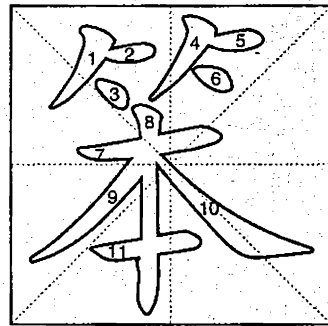

笨 bèn 65

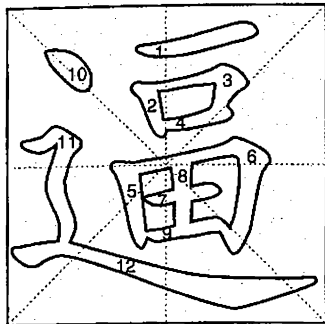

逼 bī 66

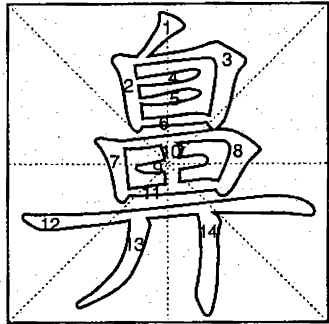

鼻 bí 67

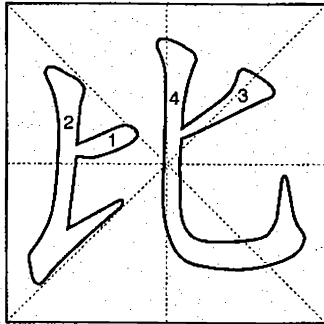

比 bǐ 68

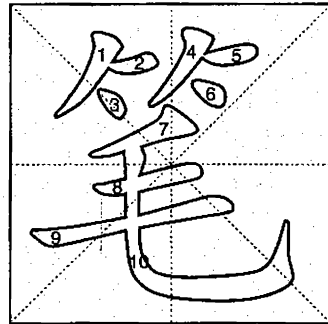

笔 bǐ 69

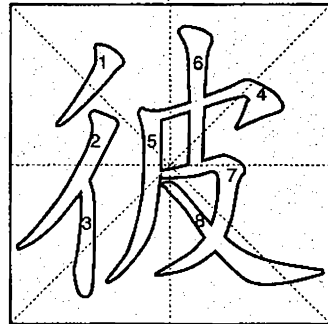

彼 bǐ 70

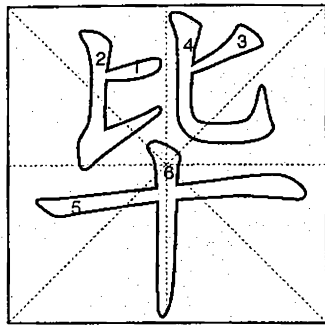

毕 bì 71

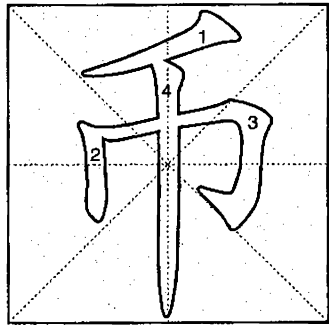

币 bì 72

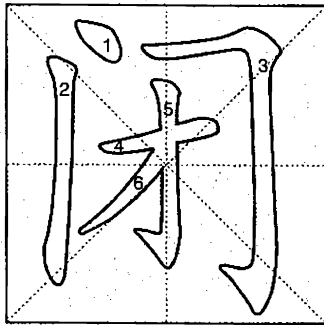

闲 xián 73

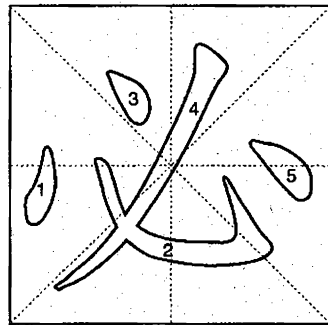

必 bì 74

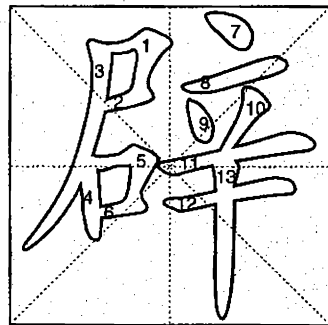

辟 pì 75

### 笨 bèn

①stupid; dull; foolish ②clumsy; awkward ③cumbersome  
笨蛋 bèn'dàn  
fool; idiot  
笨重 bèn'zhòng  
heavy; cumbersome  
笨拙 bèn'zhuō  
clumsy; awkward; stupid

### 奔 bèn

go straight towards; head for  
奔命 bèn'mìng  
be in a desperate hurry

### 本 běn

①the root or stem of a plant  
②foundation; basis; origin  
③capital; principal  
本科 běn'kē  
undergraduate course  
本职 běn'zhí  
one's job (or duty)  
本子 běn'zi  
book; notebook; edition

### 奔 bēn

①run quickly  
②hurry; hasten; rush  
奔驰 bēn'chí  
run quickly; speed  
奔赴 bēn'fù  
go to; hurry to; rush to  
奔跑 bēn'pǎo  
run

### 被 bèi

quilt  
被单 bèi'dān  
bed sheet  
被迫 bèi'pò  
be compelled; be forced  
被套 bèi'tào  
bedding bag; quilt cover  
被子 bèi'zi  
quilt

### 彼 bǐ

①that; those; the other; another  
②the other party  
彼此 bǐ'ci  
each other; one another

### 笔 bǐ

①pen ②technique of writing, calligraphy or drawing ③write  
④stroke; touch  
笔记 bǐ'jì  
notes  
笔名 bǐ'míng  
pen name; pseudonym  
笔直 bǐ'zhí  
perfectly straight

### 比 bǐ

①compare; contrast ②emulate; compete; match ③draw an analogy; liken to; compare to ④ratio; proportion  
比率 bǐ'lǜ  
ratio; rate  
比如 bǐ'rú  
for example; such as  
比萨饼 bǐ'sà'bǐng  
pizza

### 鼻 bí

nose  
鼻孔 bí'kǒng  
nostril  
鼻梁 bí'liáng  
bridge of the nose  
鼻炎 bí'yán  
rhinitis

### 逼 bī

①force; compel; drive  
②extort  
逼供 bī'gòng  
extort a confession  
逼近 bī'jìn  
press on towards; close in on  
逼真 bī'zhēn  
lifelike; true to life

### 辟 bì

monarch; sovereign  
复辟 fù'bì  
restore a dethroned monarch or the old order

### 必 bì

certainly; surely  
必须 bì'xū  
must; have to  
必需 bì'xū  
essential; indispensable  
必要 bì'yào  
necessary; essential

### 闭 bì

①shut; close  
②stop up; obstruct  
闭幕 bì'mù  
the curtain falls  
闭幕式 bì'mù'shì  
closing ceremony  
闭塞 bì'sè  
stop up; out-of-the-way

### 币 bì

money; currency  
币值 bì'zhí  
currency value  
币制 bì'zhì  
currency system

### 毕 bì

①finish ②completely  
毕竟 bì'jìng  
after all; all in all  
毕生 bì'shēng  
all one's life; lifetime  
毕业 bì'yè  
graduate; finish school

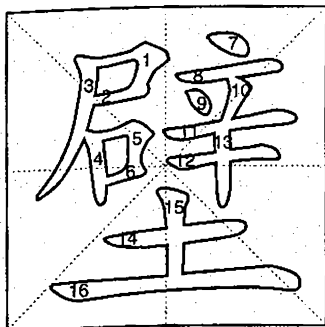

壁 bì 76

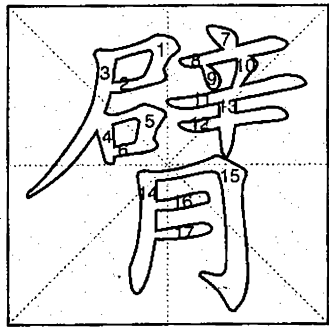

臂 bì 77

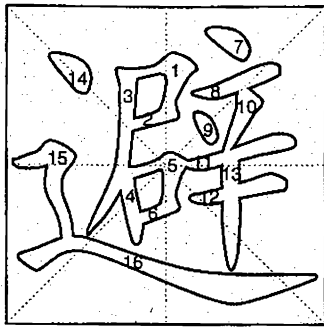

避 bì 78

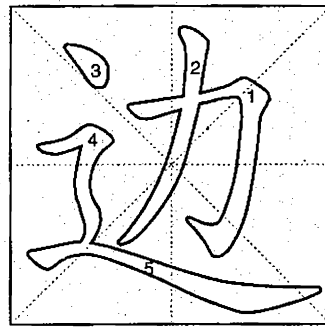

边 biān 79

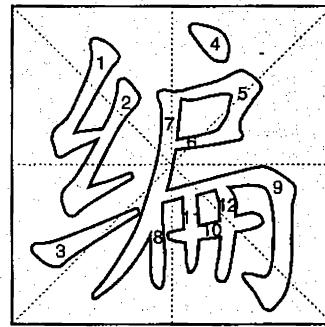

编 biān 80

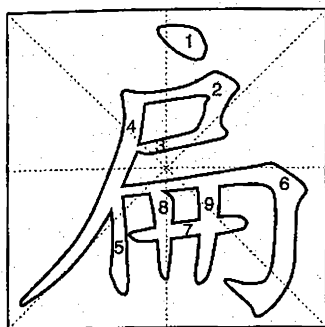

扁 biǎn 81

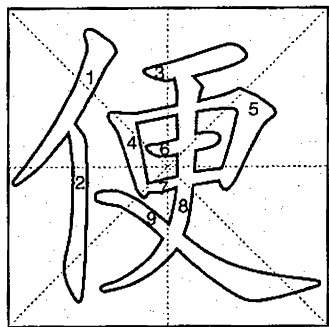

便 biàn 82

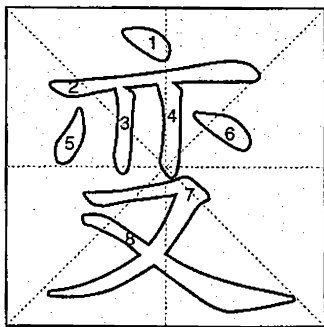

变 biàn 83

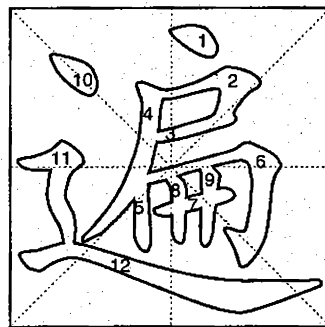

遍 biàn 84

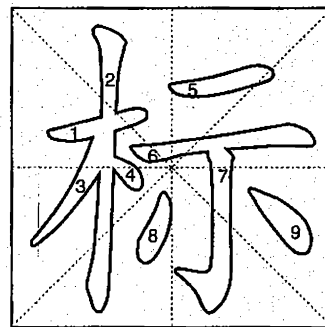

标 biāo 85



表 biǎo 86



别 bié 87

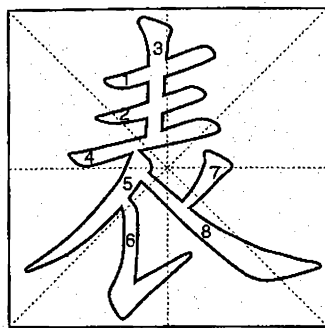
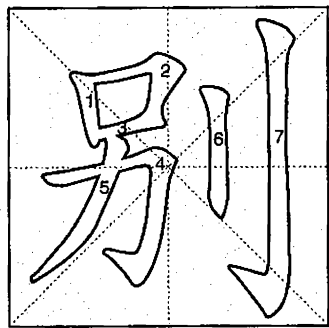
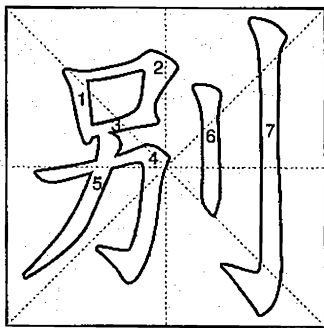

别 biè 88

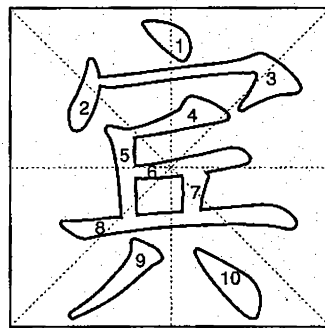

宾 bīn 89

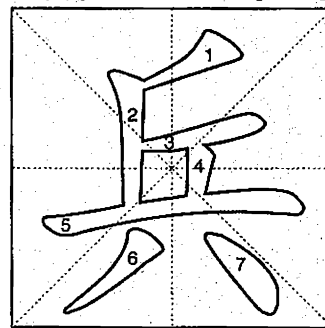

兵 bīng 90



**编 biān**

① weave; plait ② organize; group; arrange ③ edit; compile

④ write; compose ⑤ fabricate; invent; make up

编辑 biān'jī

edit; compile

编剧 biān'jù

screenwriter; scenarist

编排 biān'pái

arrange; lay out

**边 biān**

① side ② margin; edge; brim; rim ③ border; frontier; boundary

④ limit; bound ⑤ by the side of; close by

边防 biān'fáng

frontier defence

边界 biān'jiè

boundary; border

边缘 biān'yuán

edge; fringe; verge

**避 bì**

① avoid; evade; shun

② prevent; keep away; repel

避风港 bì'fēng'gǎng

haven; harbor

避免 bì'miǎn

avoid; refrain from

避孕套 bì'yùn'tào

condom

**臂 bì**

① arm ② upper arm

臂膀 bì'bǎng

arm

**壁 bì**

① wall ② cliff ③ rampart; breastwork

壁灯 bì'dēng

wall lamp; bracket light

壁炉 bì'lú

fireplace

壁纸 bì'zhǐ

wallpaper

**标 biāo**

① mark; sign ② put a mark, tag or label on; label ③ prize; award

④ outward sign; symptom ⑤ tender; bid

标记 biāo'jì

sign; mark; show

标价 biāo'jià

mark a price; marked price

标签 biāo'qiān

label; tag

**遍 biàn**

all over; everywhere

遍布 biàn'bù

be found everywhere

遍地开花 biàn'dì'kāi'huā

blossom everywhere

遍及 biàn'jí

extend (or spread) all over

**变 biàn**

① change; become different

② change into; become ③ transform; alter ④ an unexpected turn of events

变更 biàn'gēng

change; alter; modify

变迁 biàn'qiān

changes; vicissitudes

变心 biàn'xīn

cease to be faithful

**便 biàn**

① convenient; handy ② informal; plain ③ piss or shit; urine or excrement

便餐 biàn'cān

a simple meal

便笺 biàn'jiān

notepaper; memo pad

便条 biàn'tiáo

a brief note

**扁 biǎn**

flat

扁担 biǎn'dān

carrying pole; shoulder pole

扁豆 biǎn'dòu

hyacinth bean

扁桃体(生理)

biǎn'tǎo'tǐ (shēng'lǐ)

tonsil

**兵 bīng**

① weapons; arms ② soldier

③ rank-and-file soldier; private

④ army; troops ⑤ military

兵力 bīng'lì

military strength

兵役 bīng'yì

military service

兵营 bīng'yíng

military camp; barracks

**宾 bīn**

guest

宾馆 bīn'guǎn

guesthouse

宾朋 bīn'péng

guests

宾语 bīn'yǔ

object

**别 bié**

别扭 bié'niū

awkward; difficult

**别 bié**

① leave ② other ③ difference

④ distinguish ⑤ fasten with a pin or clip ⑥ stick in ⑦ don't

别称 bié'chēng

another name

别墅 bié'shù

villa

别有风味 bié'yǒu'fēng'wèi

have a distinctive flavor

**表 biǎo**

① surface; outside; external

② show; express ③ table; form; list

④ meter; gauge ⑤ watch

表格 biǎo'gé

form; table

表决 biǎo'jué

decide by vote; vote by ballot

表演 biǎo'yǎn

perform; act; play

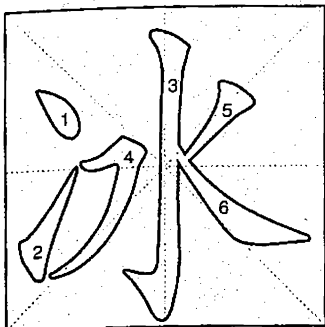

冰 bīng 91

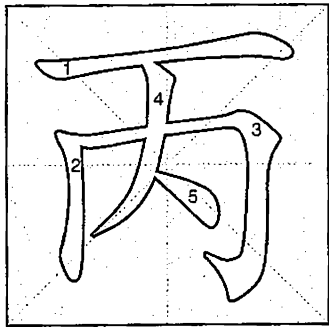

丙 bǐng 92

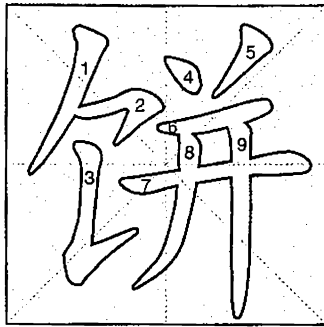

饼 bǐng 93

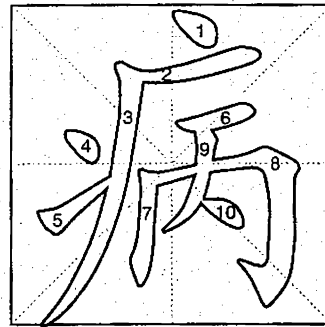

病 bìng 94

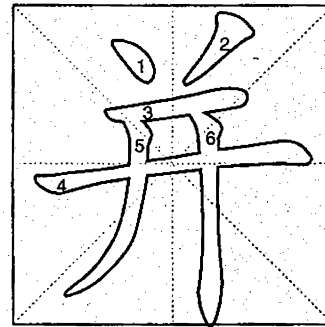

并 bìng 95

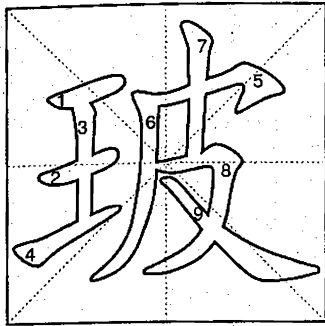

玻 bō 96

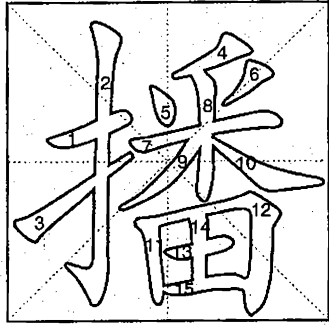

播 bō 97

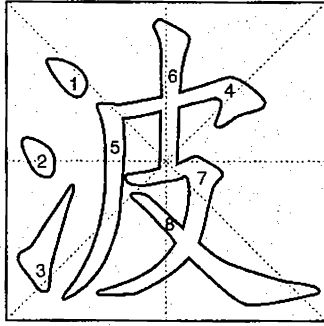

波 bō 98

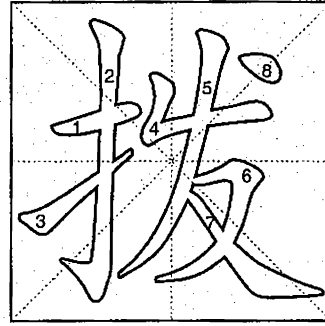

拨 bō 99

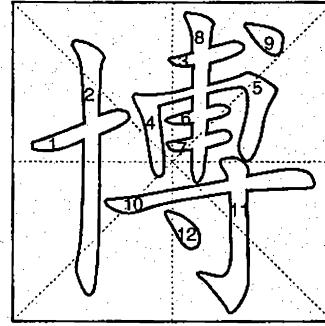

博 bó 100

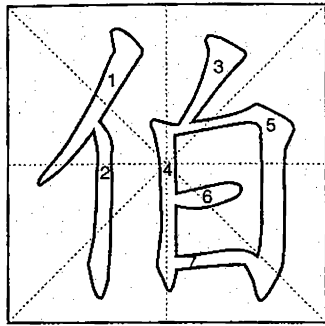

伯 bó 101

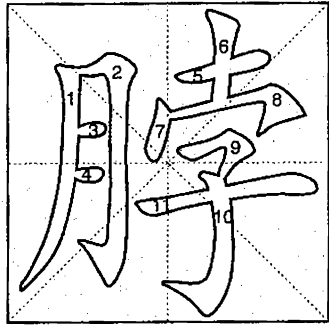

脖 bó 102

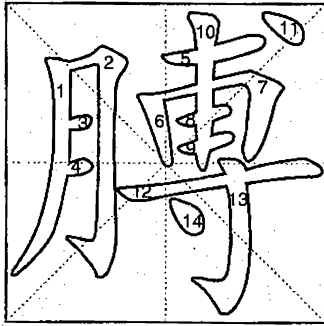

膊 bó 103

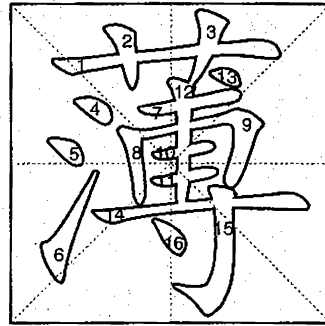

薄 bò 104

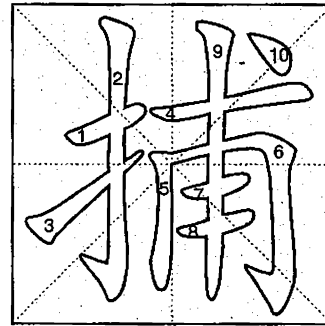

捕 bǔ 105

### 并 bìng

- ①combine; merge; incorporate  
 ②equally; side by side  
 ③and

并肩 bìng'jiān  
 shoulder to shoulder  
 并列 bìng'liè  
 stand side by side  
 并吞 bìng'tūn  
 swallow up; annex; merge

### 病 bìng

- ①ill; sick ②disease ③fault; defect  
 病毒 bìng'dú  
 virus  
 病假 bìng'jià  
 sick leave  
 病人 bìng'rén  
 patient; invalid

### 饼 bǐng

- a round flat cake  
 饼干 bǐng'gān  
 biscuit; cracker

### 丙 bǐng

third

### 冰 bīng

- ①ice ②put on the ice; ice  
 ③feel cold  
 冰柜 bīng'guì  
 refrigerator; freezer  
 冰糖 bīng'táng  
 crystal sugar. -葫芦(hú'lú)  
 candied haws on a stick  
 冰镇 bīng'zhèn  
 iced

### 博 bó

- ①rich; abundant; plentiful  
 ②win; gain  
 博览会 bó'lǎn'huì  
 fair  
 博士 bó'shì  
 doctor  
 博物馆 bó'wù'guǎn  
 museum

### 拨 bō

- ①move with hand, foot, stick, etc.; turn; stir; poke ②set aside; assign (rooms, workers, etc.)  
 拨电话 bō'diàn'huà  
 dial a telephone  
 拨开 bō'kāi  
 push aside  
 拨款 bō'kuǎn  
 allocate funds

### 波 bō

- wave  
 波长 bō'cháng  
 wavelength  
 波浪 bō'làng  
 wave  
 波纹 bō'wén  
 ripple

### 播 bō

- ①sow; seed ②broadcast  
 播放 bō'fàng  
 broadcast; telecast  
 播音 bō'yīn  
 transmit; broadcast  
 播种 bō'zhòng  
 sowing; sow seeds

### 玻 bō

- 玻璃 bō'li  
 glass: 有机-organic glass  
 玻璃杯 bō'li'bēi  
 glass; tumbler  
 玻璃瓶 bō'li'píng  
 glass bottle

### 捕 bǔ

- catch; seize; arrest  
 捕捞 bǔ'lāo  
 fish for; catch  
 捕鱼 bǔ'yú  
 catch fish; fish  
 捕捉 bǔ'zhuō  
 catch; seize

### 薄 báo

- 薄荷 bà'he  
 peppermint  
 薄荷油 bà'he'yóu  
 peppermint oil

### 膊 bó

- arm  
 胳膊 gē'bo  
 arm  
 赤膊 chì'bó  
 barebacked

### 脖 bó

- neck  
 脖颈 bó'gěng  
 back of the neck; nape  
 脖子 bó'zi  
 neck

### 伯 bó

- ①father's elder brother; uncle  
 ②the eldest of brothers  
 伯伯(伯父) bó'bo(bó'fù)  
 uncle  
 伯爵 bó'jué  
 earl; count: -夫人 countess  
 伯母 bó'mǔ  
 aunt

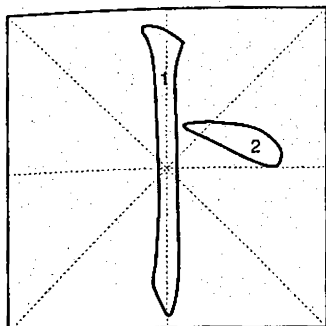

卜 bǔ 106

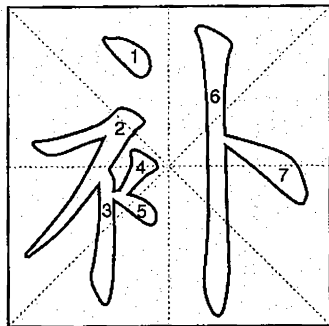

补 bǔ 107

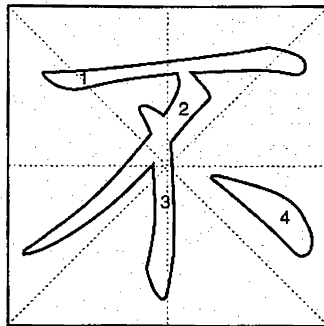

不 bù 108

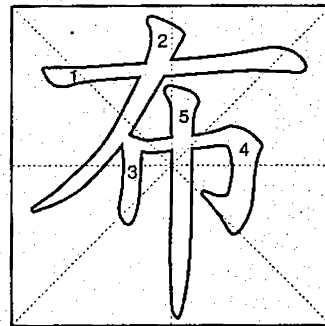

布 bù 109

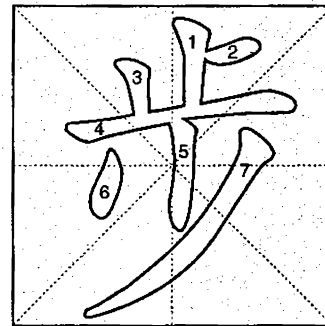

步 bù 110

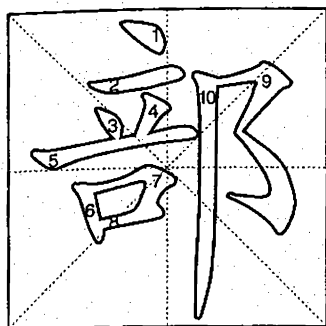

部 bù 111

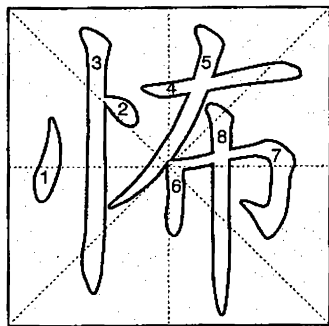

怖 bù 112

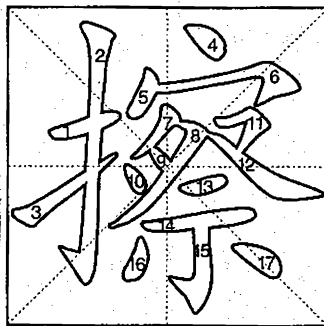

擦 cā 113

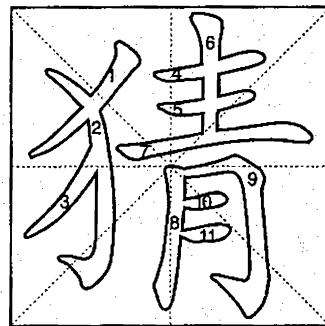

猜 cāi 114

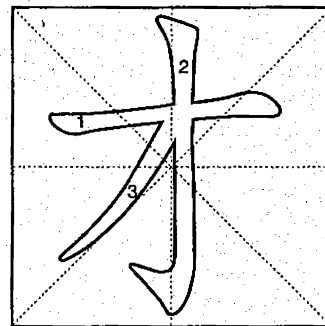

才 cái 115

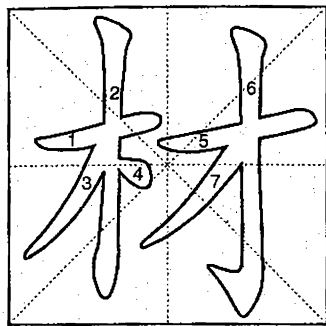

材 cái 116

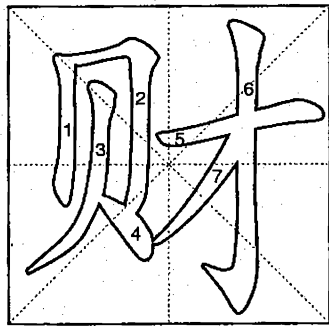

财 cái 117

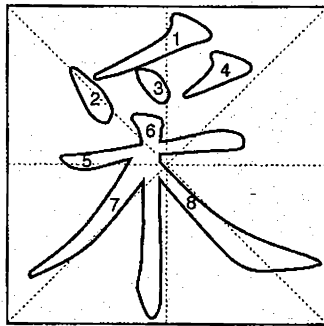

采 cǎi 118

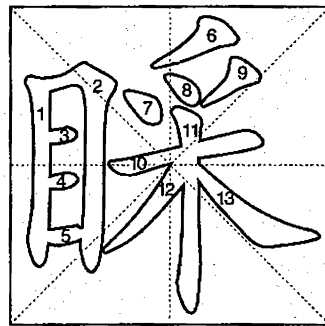

睬 cǎi 119

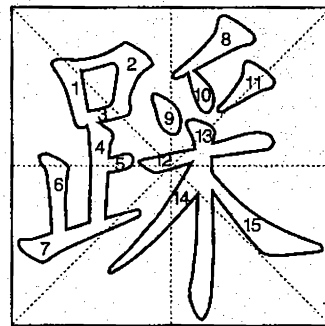

睬 cǎi 120

### 步 bù

- ①step; pace ②stage; step  
 ③condition; situation; state  
 ④walk; go on foot  
 步话机 bù'huà'jī  
 walkie-talkie  
 步枪 bù'qiāng  
 rifle  
 步行 bù'xíng  
 go on foot; walk

### 布 bù

- ①cloth ②declare; announce;  
 publish ③spread; disseminate  
 ④dispose; arrange; deploy  
 布告 bù'gào  
 notice; bulletin  
 布谷鸟 bù'gǔ'niǎo  
 cuckoo  
 布料 bù'liào  
 cotton material

### 不 bù

- not; no  
 不但 bù'dàn  
 not only  
 不对 bù'duì  
 incorrect; wrong; no  
 不敢 bù'gǎn  
 dare not; not dare

### 补 bǔ

- ①mend; patch; repair ②fill;  
 supply; make up for (a loss)  
 ③nourish ④benefit; use; help  
 补偿 bǔ'cháng  
 compensate sb. for a loss  
 补救 bǔ'jiù  
 remedy  
 补品 bǔ'pǐn  
 tonic; restoratives

### 卜 bǔ

- ①divination; fortune-telling  
 ②foretell; predict  
 ③select; choose

### 才 cái

- ①ability; talent; gift ②capable  
 person ③people of a certain type  
 ④just; only  
 才干 cái'gàn  
 ability; competence  
 才能 cái'néng  
 ability; talent  
 才子 cái'zǐ  
 gifted scholar

### 猜 cāi

- ①guess; conjecture; speculate  
 ②suspect  
 猜测 cāi'cè  
 guess; conjecture  
 猜想 cāi'xiǎng  
 suppose; guess; suspect  
 猜中 cāi'zhòng  
 guess correctly; solve

### 擦 cā

- ①rub; graze; scratch ②wipe; scrub  
 ③spread on; put on ④brush; shave  
 ⑤scrape (into shreds)  
 擦干 cā'gān  
 wipe sth. dry  
 擦去 cā'qù  
 wipe off  
 擦伤 cā'shāng  
 abrasion; gall; scratch

### 怖 bù

- fear; be afraid of  
 恐怖 kǒng'bù  
 terror; horror  
 恐怖主义 kǒng'bù'zhǔ'yì  
 terrorism

### 部 bù

- ①part; section ②unit; ministry;  
 department; board ③headquarters  
 部队 bù'duì  
 army; armed forces  
 部门 bù'mén  
 department; branch  
 部长 bù'zhǎng  
 minister

### 踩 cǎi

- step on; trample  
 踩水 cǎi'shuǐ  
 tread water  
 踩线 cǎi'xiàn  
 step on the line

### 睬 cǎi

- pay attention to; take notice of

### 采 cǎi

- ①pick; pluck; gather ②mine;  
 extract ③adopt; select ④com-  
 plexion; spirit  
 采伐 cǎi'fá  
 fell; cut; cut over  
 采矿 cǎi'kuàng  
 mining  
 采纳 cǎi'nà  
 accept; adopt

### 财 cái

- wealth; money  
 财宝 cái'bǎo  
 money and valuables  
 财力 cái'lì  
 financial resources  
 财物 cái'wù  
 property; belongings

### 材 cái

- ①timber ②material ③ability;  
 talent; aptitude ④capable person  
 材料 cái'liào  
 material; data makings

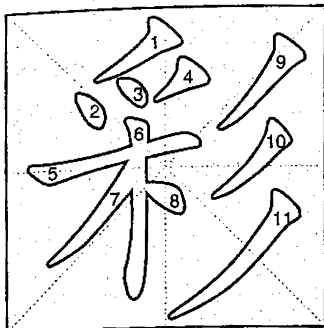

彩 cǎi 121

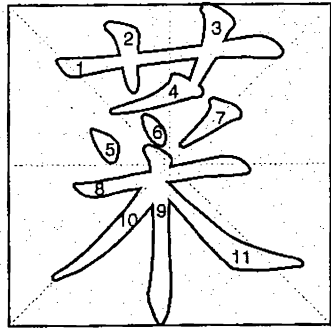

菜 cài 122

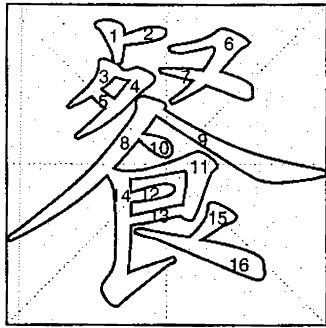

餐 cān 123

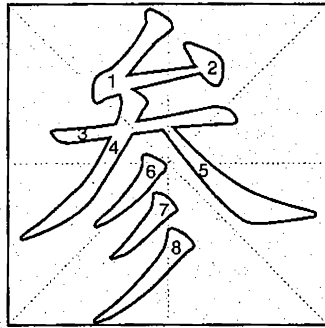

参 cān 124

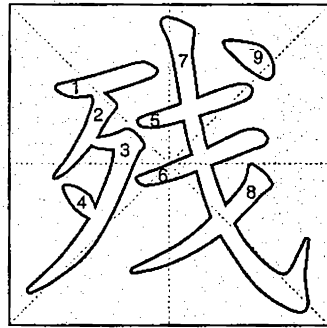

残 cán 125

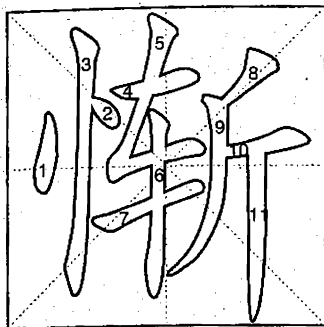

惭 cán 126

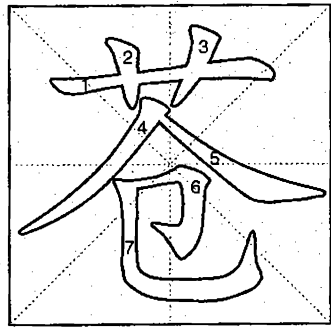

苍 cāng 127

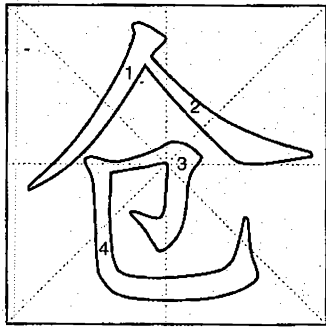

仓 cāng 128

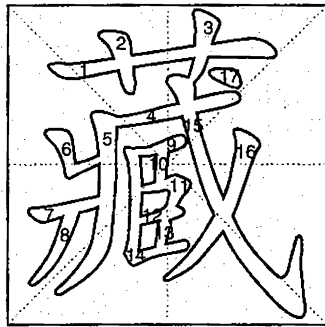

藏 cáng 129

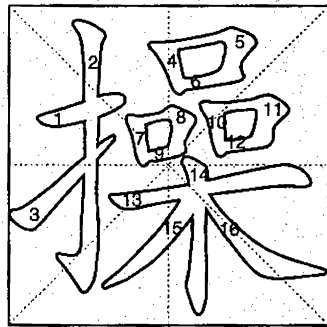

操 cāo 130

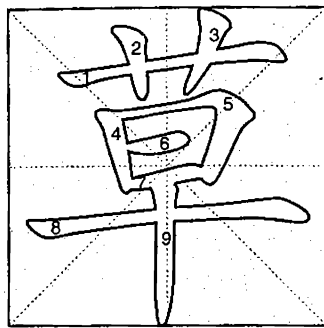

草 cǎo 131

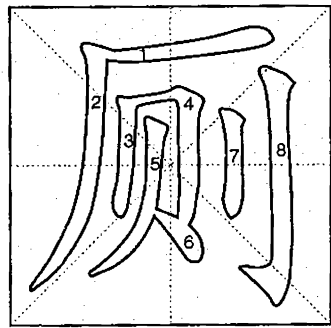

厕 cè 132

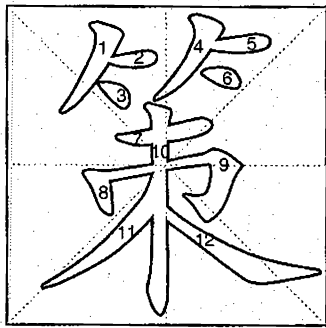

策 cè 133

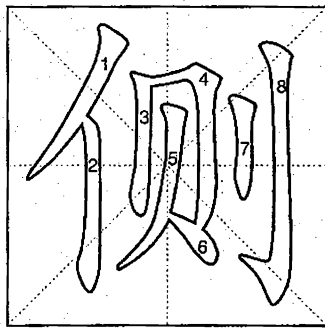

侧 cè 134

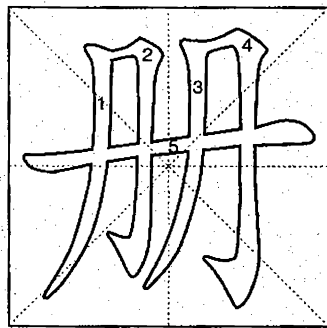

册 cè 135

### 残 cán

- ① deficient ② remaining ③ injure; damage ④ savage; ferocious  
 残废 cán'fèi  
 maimed; crippled  
 残疾 cán'jí  
 deformity  
 残酷 cán'kù  
 cruel; brutal; ruthless

### 参 cān

- ① join; enter; take part in  
 ② refer; consult  
 ③ pay one's respects to  
 参观 cān'guān  
 visit; look around  
 参加 cān'jiā  
 join; attend  
 参展 cān'zhǎn  
 participate in an exhibition

### 餐 cān

- ① eat ② food; meal  
 餐馆 cān'guǎn  
 restaurant  
 餐巾 cān'jīn  
 table napkin  
 餐厅 cān'tīng  
 dining room

### 菜 cài

- ① vegetable; greens ② (nonstaple) food ③ dish; course  
 菜单 cài'dān  
 menu; bill of fare  
 菜刀 cài'dāo  
 kitchen knife  
 菜肴 cài'yáo  
 cooked food

### 彩 cǎi

- ① colour ② applause; cheer  
 ③ variety ④ prize  
 彩电 cǎi'diàn  
 color television  
 彩卷 cǎi'juǎn  
 color film  
 彩票 cǎi'piào  
 lottery ticket

### 操 cāo

- ① grasp; hold ② act; do; operate  
 ③ speak (a language or dialect)  
 ④ drill; exercise ⑤ conduct; behaviour  
 操场 cāo'chǎng  
 playground; sports ground  
 操练 cāo'liàn  
 drill; practice  
 操心 cāo'xīn  
 worry about

### 藏 cáng

- ① hide; conceal  
 ② store; lay by  
 藏匿 cáng'nì  
 conceal; hide; go into hiding  
 藏身 cáng'shēn  
 hide oneself  
 藏书 cáng'shū  
 collect books

### 仓 cāng

- storehouse; warehouse  
 仓储 cāng'chǔ  
 keep sth. in a storehouse  
 仓促 cāng'cù  
 hurriedly; hastily  
 仓库 cāng'kù  
 warehouse; storehouse

### 苍 cāng

- ① dark green ② blue  
 ③ grey; ashy  
 苍白 cāng'bái  
 pale; pallid; wan  
 苍老 cāng'lǎo  
 old; aged  
 苍蝇 cāng'yīng  
 fly

### 惭 cán

- feel ashamed  
 惭愧 cán'kuì  
 be ashamed

### 册 cè

- ① volume; book ② copy  
 册封 cè'fēng  
 confer titles of nobility on  
 册子 cè'zi  
 book; volume

### 侧 cè

- ① side ② incline; lean  
 侧门 cè'mén  
 side door  
 侧影 cè'yǐng  
 silhouette; profile  
 侧重 cè'zhòng  
 lay particular emphasis on

### 策 cè

- ① plan; scheme; strategy ② whip  
 策划 cè'huà  
 plan; plot; scheme  
 策略 cè'lüè  
 tactics; tactful  
 策源地 cè'yuán'dì  
 source; place of origin

### 厕 cè

- lavatory; toilet; washroom; W.C.  
 厕所 cè'suǒ  
 lavatory; toilet; W.C.

### 草 cǎo

- ① grass; straw ② careless; hasty;  
 rough ③ draft (a document, etc.)  
 草场 cǎo'chǎng  
 grassland  
 草莓 cǎo'méi  
 strawberry  
 草纸 cǎo'zhǐ  
 toilet paper

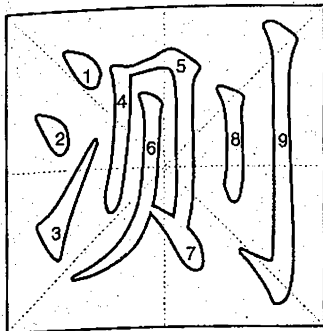

测 cè 136

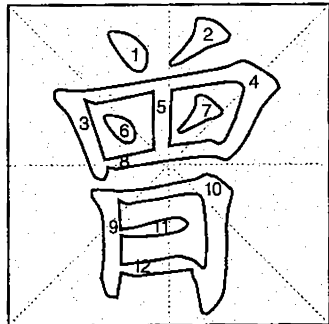

曾 céng 137

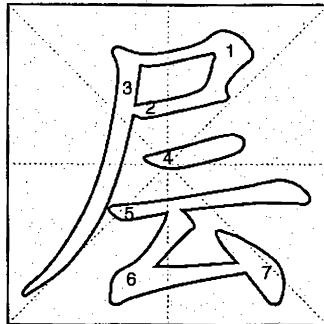

层 céng 138

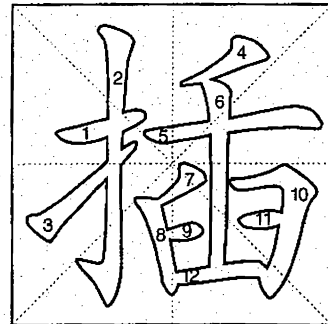

插 chā 139

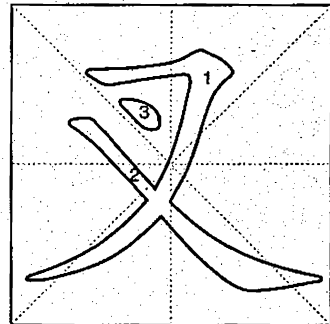

叉 chā 140

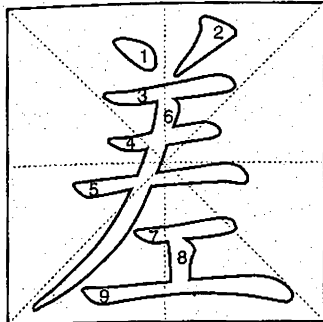

差 chā 141

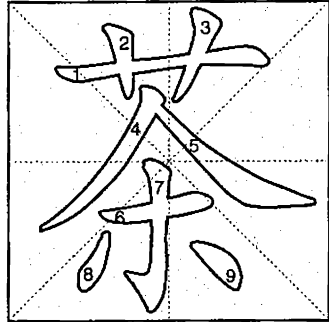

茶 chá 142

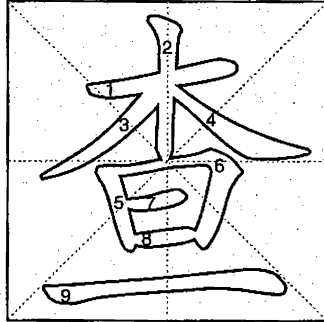

查 chá 143

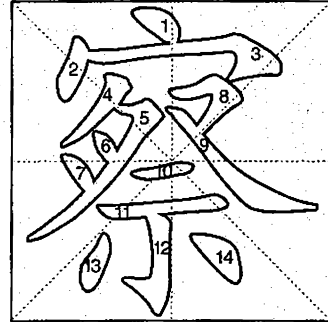

察 chá 144

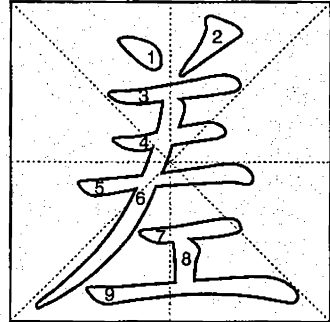

差 chà 145

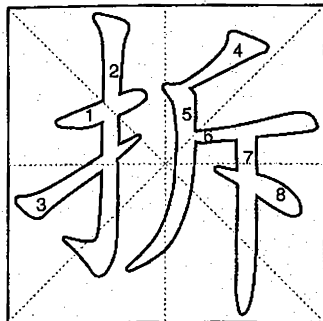

拆 chāi 146

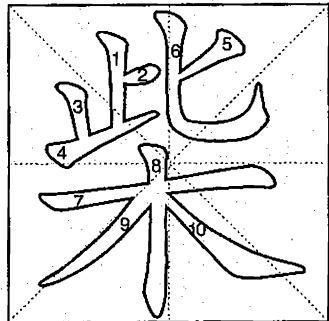

柴 chái 147

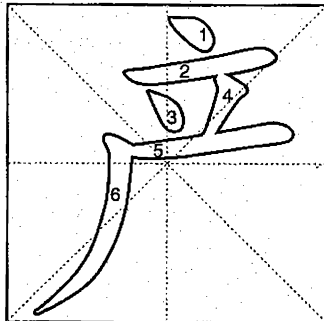

产 chǎn 148

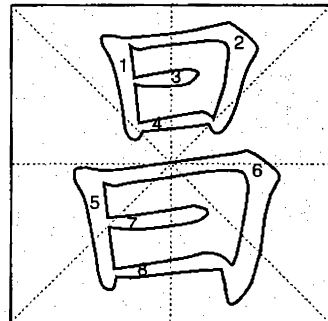

昌 chāng 149

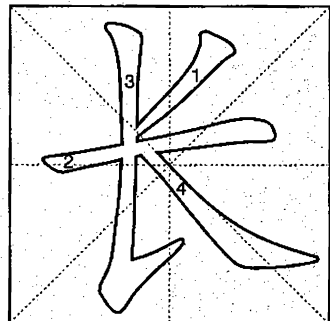

长 cháng 150



### 叉 chā

part so as to form a fork; fork; cross

叉车 chā'chē

forklift; fork truck; forklift truck

叉烧 chā'shāo

grilled pork

叉子 chā'zi

fork

### 插 chā

①stick in; insert ~门 bolt the door ②interpose

插头(电) chā'tóu(diàn)

plug

插销 chā'xiāo

bolt (for a door); plug

插座(电) chā'zuò(diàn)

socket; outlet

### 层 céng

①layer; tier; stratum

②storey; floor

层层 céng'céng

layer upon layer

层出不穷 céng'chū'bù'qióng

emerge in an endless stream

层次 céng'cì

administrative or education levels; arrangement of ideas

### 曾 céng

曾几何时 céng'jǐ'hé'shí

before long

曾经 céng'jīng

once, formerly

### 测 cè

①survey; fathom; measure

②conjecture; infer

测量 cè'liáng

survey; measure; gauge

测试 cè'shì

test

测验 cè'yàn

test

### 差 chā

①differ from; fall short of

②wrong ③wanting; short of

差不多 chà'bu'duō

almost; just about

差得多 chà'de'duō

very different; entirely different;

way below

差点儿 chà'diǎnr

not quite up to the mark; almost; nearly

### 察 chá

examine; look into; scrutinize

察访 chá'fǎng

go about to find out

察觉 chá'jué

be conscious of; perceive

察看 chá'kàn

watch; observe

### 查 chá

①check; examine ②look into;

investigate ③look up; consult

查看 chá'kàn

lookover; examine

查血 chá'xuè

have a blood test

查找 chá'zhǎo

look for

### 茶 chá

tea

茶杯 chá'bēi

teacup

茶壶 chá'hú

teapot

茶叶 chá'yè

tea; tea leaves

### 差 chā

①difference; dissimilarity

②mistake

差错 chā'cuò

mistake; error; slip

差额 chā'é

difference; balance

差距 chā'jù

gap; disparity

### 长 cháng

①long ②length ③lasting

④steadily; regularly ⑤strong point; forte

长城 cháng'chéng

The Great Wall

长度 cháng'dù

length

长途电话 cháng'tú'diànhuà

long-distance call

### 昌 chāng

prosperous; flourishing

昌明 chāng'míng

thriving; well-developed

昌盛 chāng'shèng

prosperous

### 产 chǎn

①give birth to ②produce; property; estate

产地 chǎn'dì

place of production

产量 chǎn'liàng

output; yield

产品 chǎn'pǐn

product; produce

### 柴 chái

firewood

柴草 chái'cǎo

firewood; faggot

柴火 chái'huo

faggot

柴油 chái'yóu

diesel oil

### 拆 chāi

①tear open; take apart

②pull down; dismantle

拆封 chāi'fēng

seal off

拆开 chāi'kāi

take apart; open; separate

拆洗 chāi'xǐ

wash; strip and clean

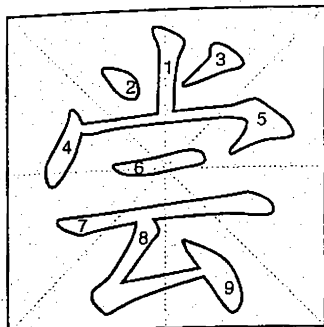

尝 cháng 151

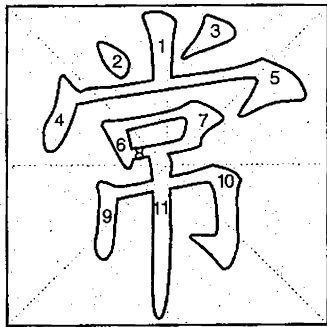

常 cháng 152

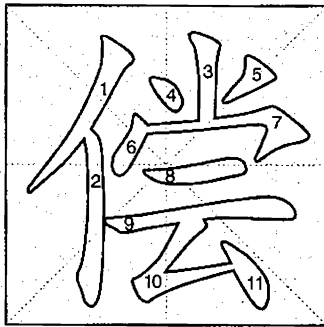

偿 cháng 153

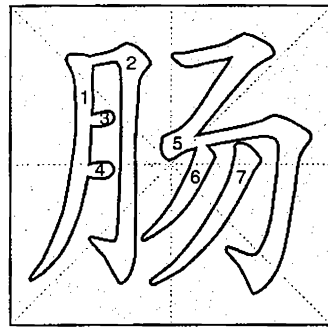

肠 cháng 154

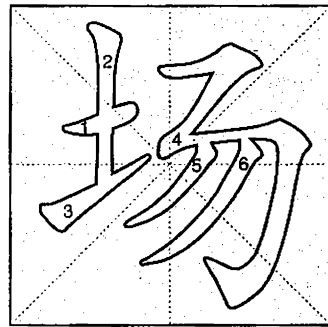

场 chǎng 155

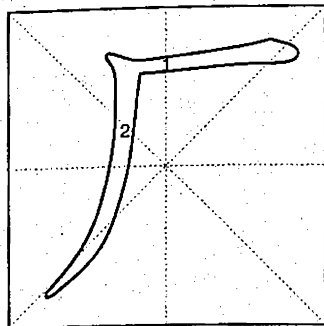

厂 chǎng 156

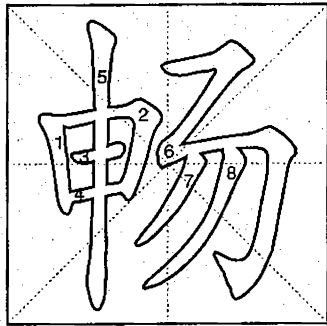

畅 chàng 157

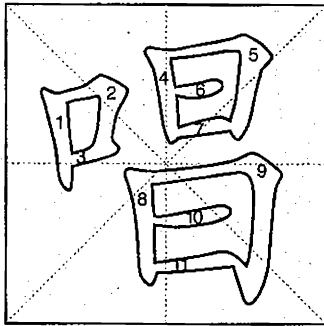

唱 chàng 158

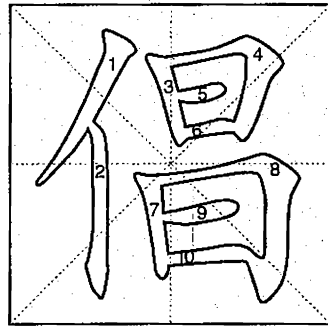

倡 chàng 159

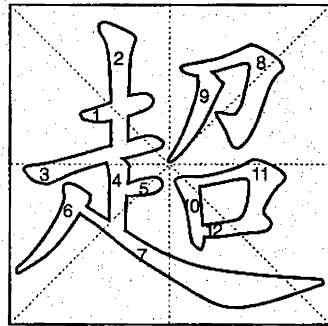

超 chāo 160

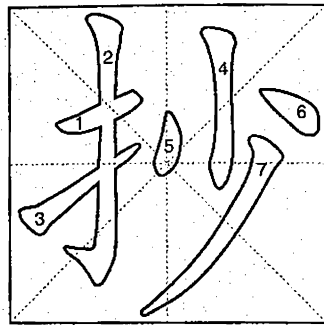

抄 chāo 161

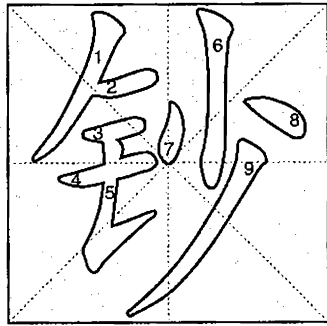

钞 chāo 162

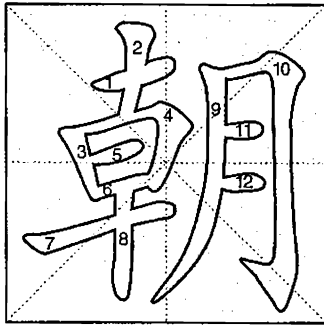

朝 cháo 163

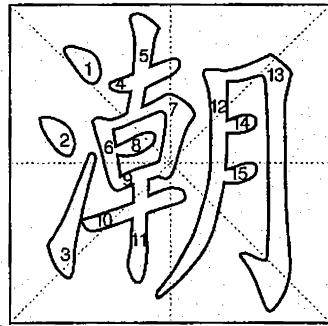

潮 cháo 164

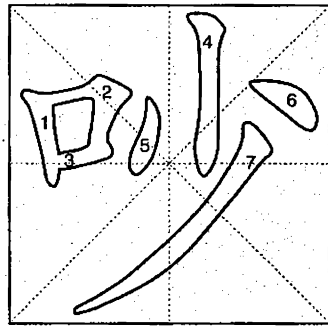

吵 chǎo 165

### 场 chǎng

- ① a place where people gather  
 ② farm ③ stage ④ scene  
 场地 chǎng'dì  
 space; place; site  
 场合 chǎng'hé  
 occasion; situation  
 场所 chǎng'suǒ  
 place; arena

### 肠 cháng

- intestines  
 肠胃 cháng'wèi  
 intestines and stomach  
 肠胃病 cháng'wèi'bìng  
 indigestion  
 肠炎 cháng'yán  
 enteritis

### 偿 cháng

- ① repay; compensate for ~ 债 pay a debt ② meet; fulfil  
 偿付 cháng'fù  
 pay back; pay  
 偿还 cháng'huán  
 repay; pay back  
 偿清 cháng'qīng  
 clear off

### 常 cháng

- ① ordinary; common; normal  
 ② constant; invariable  
 ③ frequently; often; usually  
 常常 cháng'cháng  
 frequently; often  
 常客 cháng'kè  
 regular customer  
 常识 cháng'shí  
 general knowledge

### 尝 cháng

- ① taste; try the flavour of  
 ② ever; once  
 尝试 cháng'shì  
 attempt; try  
 尝新 cháng'xīn  
 have a taste of what is just in season

### 超 chāo

- ① exceed; surpass; overtake  
 ② ultra; super; extra  
 ③ transcend; go beyond  
 超车 chāo'chē  
 overtake other cars  
 超龄 chāo'líng  
 overage  
 超人 chāo'rén  
 superman

### 倡 chàng

- initiate; advocate  
 倡导 chàng'dǎo  
 initiate; propose  
 倡议 chàng'yì  
 propose  
 倡议者 chàng'yì'zhě  
 initiator

### 唱 chàng

- ① sing ② call; cry  
 唱歌 chàng'gē  
 sing (a song)  
 唱盘 chàng'pán  
 disk:激光~compact disc; CD  
 唱片 chàng'piàn  
 gramophone record

### 畅 chàng

- ① smooth; unimpeded ② free; uninhibited  
 畅销 chàng'xiāo  
 be in great demand  
 畅销书 chàng'xiāo'shū  
 best seller  
 畅饮 chàng'yǐn  
 drink one's fill

### 厂 chǎng

- ① factory; mill; plant; works  
 ② yard; depot  
 厂房 chǎng'fáng  
 factory building  
 厂商 chǎng'shāng  
 firm  
 厂主 chǎng'zhǔ  
 factory owner; millowner

### 吵 chǎo

- ① make a noise  
 ② quarrel; squabble  
 吵闹 chǎo'nào  
 wrangle; kick up a row  
 吵嚷 chǎo'rǎng  
 make a racket  
 吵嘴 chǎo'zuǐ  
 bicker

### 潮 cháo

- ① tide; upsurge; current  
 ② damp; moist  
 潮流 cháo'liú  
 tide; tidal current; trend  
 潮湿 cháo'shī  
 moist  
 潮水 cháo'shuǐ  
 tidewater

### 朝 cháo

- ① court; government ② dynasty  
 ③ facing; towards  
 朝代 cháo'dài  
 dynasty  
 朝廷 cháo'tíng  
 royal court  
 朝政 cháo'zhèng  
 affairs of state

### 钞 chāo

- ① bank note ② collected writings  
 钞票 chāo'piào  
 bank note; paper money

### 抄 chāo

- ① copy; transcribe ② go off with  
 ③ grab; take up ④ search and confiscate  
 抄家 chāo'jiā  
 search sb.'s house  
 抄送 chāo'sòng  
 send a duplicate to  
 抄写 chāo'xiě  
 copy; transcribe

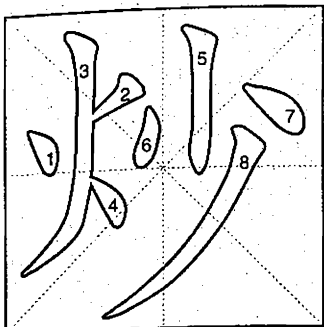

炒 chǎo 166

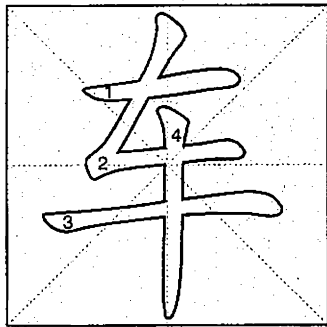

车 chē 167

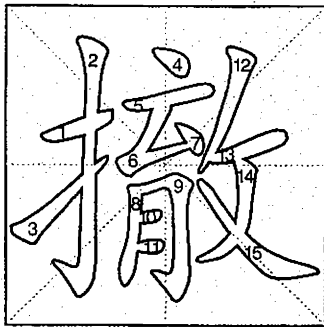

撒 chē 168

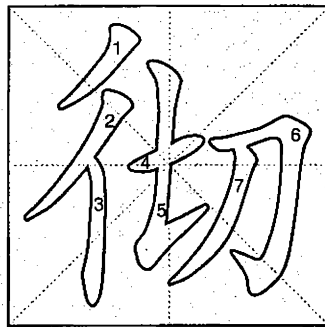

彻 chē 169

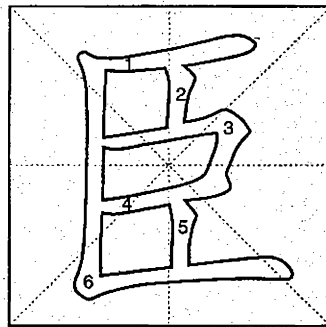

臣 chén 170

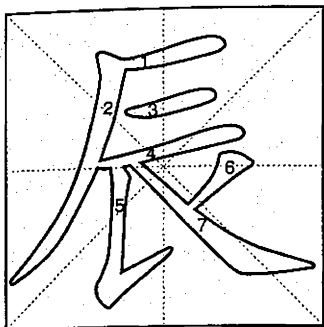

辰 chén 171

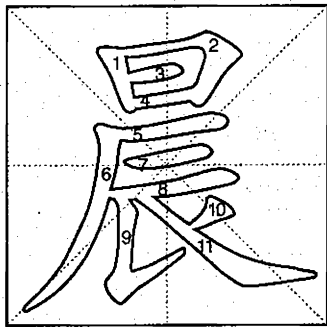

晨 chén 172

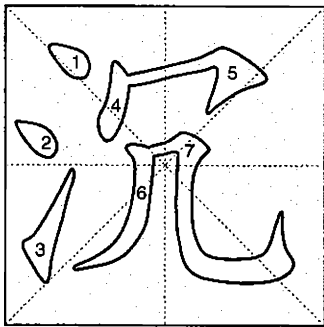

沉 chén 173

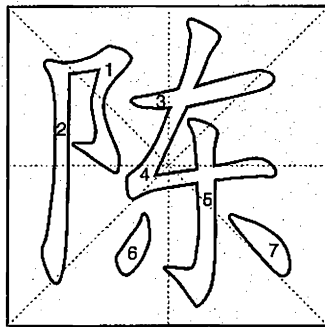

陈 chén 174

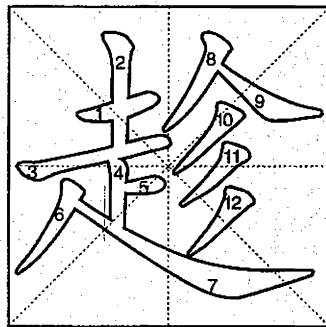

趁 chèn 175

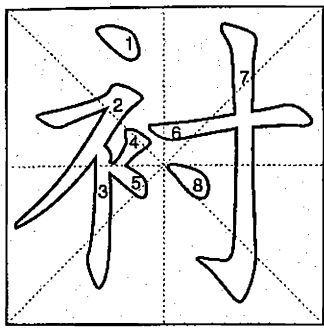

衬 chèn 176

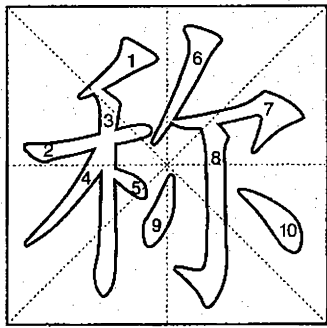

称 chèn 177

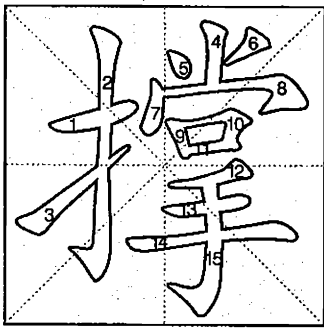

撑 chēng 178

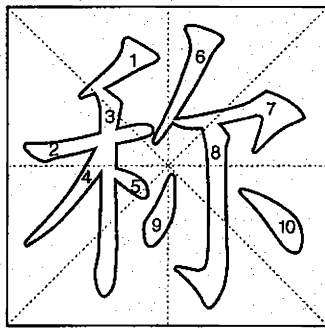

称 chēng 179

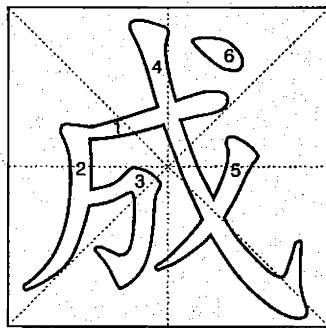

成 chéng 180

### 臣 chén

official (under a feudal ruler); subject

### 彻 chè

thorough; penetrating  
彻底 chè'dǐ  
thorough  
彻头彻尾 chè'tóu'chè'wěi  
out and out  
彻夜 chè'yè  
all night

### 撤 chè

①remove; take away ②withdraw; evacuate  
撤退 chè'tuì  
withdraw; pull out  
撤职 chè'zhí  
dismiss sb. from his post  
撤走 chè'zǒu  
withdraw

### 车 chē

①vehicle ②wheeled machine or instrument ③machine ④lathe; turn  
车次 chē'cì  
train number  
车祸 chē'huò  
traffic accident  
车间 chē'jiān  
workshop; shop

### 炒 chǎo

stir-fry  
炒饭 chǎo'fàn  
fry rice; fried rice  
炒股 chǎo'gǔ  
speculate in shares  
炒面 chǎo'miàn  
fried noodles

### 趁 chèn

①avail oneself of ②while  
③be possessed of; be rich in  
趁火打劫 chèn'huǒ'dǎ'jié  
take advantage of sb.'s misfortune to do him harm  
趁机 chèn'jī  
seize the chance  
趁空 chèn'kòng  
use one's spare time

### 陈 chén

①lay out; put on display  
②state; explain ③old; stale  
陈货 chén'huò  
old stock  
陈列 chén'liè  
display; set out; exhibit  
陈述 chén'shù  
state; declare

### 沉 chén

①sink ②keep down; lower  
③deep; profound ④heavy  
沉没 chén'mò  
sink  
沉睡 chén'shùì  
be sunk in sleep  
沉重 chén'zhòng  
heavy; serious; critical

### 晨 chén

morning  
晨风 chén'fēng  
matinal; morning breeze  
晨光 chén'guāng  
dawn  
晨星 chén'xīng  
stars at dawn

### 辰 chén

celestial bodies  
生辰 shēng'chén  
birthday  
星辰 xīng'chén  
stars and constellations; the stars

### 成 chéng

①accomplish; succeed ②become; turn into ③achievement; result ④fully developed; fully grown ⑤established; ready-made  
成本 chéng'běn  
cost  
成功 chéng'gōng  
succeed; success  
成天 chéng'tiān  
all day long; all the time

### 称 chēng

①call ②name. ③weigh  
称号 chēng'hào  
title; name; designation  
称谢 chēng'xiè  
thank  
称赞 chēng'zàn  
praise; acclaim; commend

### 撑 chēng

①prop up; support ②push or move with a pole ③maintain  
④fill to the point of bursting  
撑持 chēng'chí  
prop up; sustain  
撑船 chēng'chuán  
pole a boat  
撑杆跳高 chēng'gān'tiào'gāo  
pole vault

### 称 chèn

fit; match; suit  
称心 chèn'xīn  
find sth. satisfactory  
称职 chèn'zhí  
fill a post with credit

### 衬 chèn

①line; place sth. underneath  
②lining; liner ③set off  
衬布 chèn'bù  
lining cloth  
衬里 chèn'lǐ  
lining  
衬衫 chèn'shān  
shirt

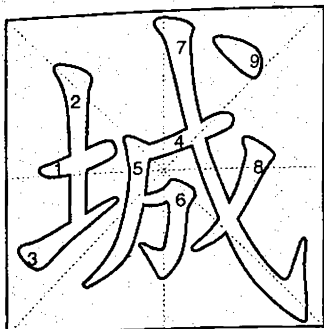

城 chéng 181

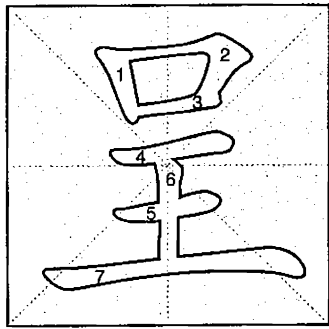

呈 chéng 182

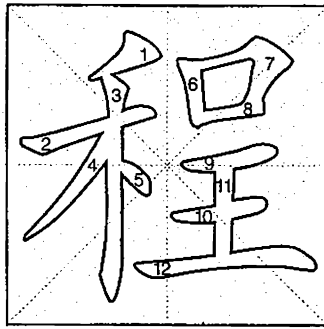

程 chéng 183

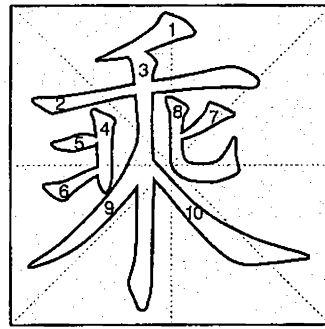

乘 chéng 184

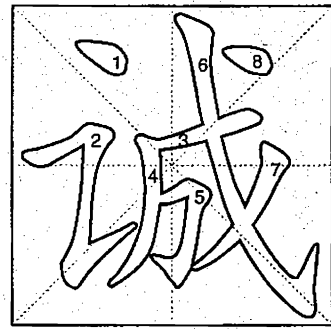

诚 chéng 185

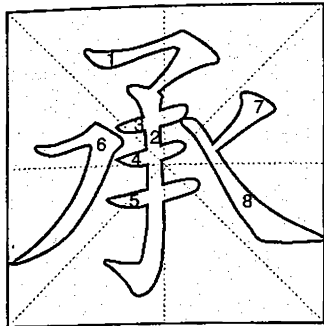

承 chéng 186

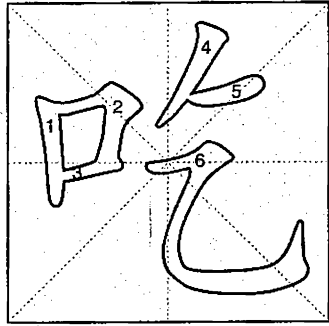

吃 chī 187

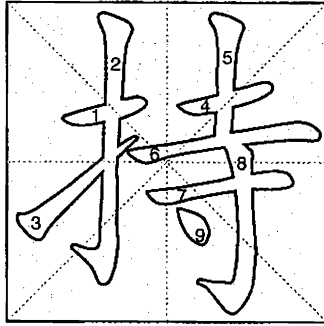

持 chí 188

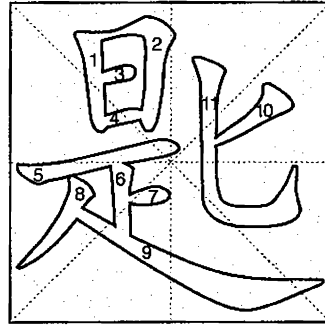

匙 chí 189

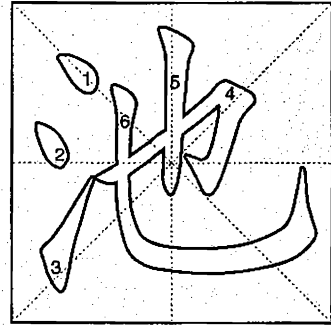

池 chí 190

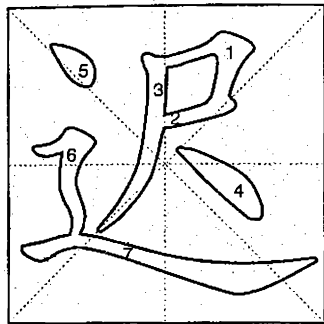

迟 chí 191

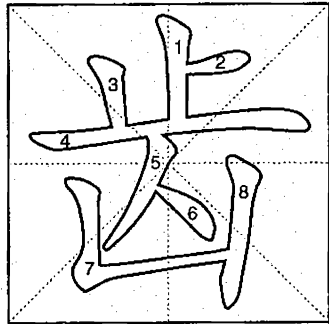

齿 chǐ 192

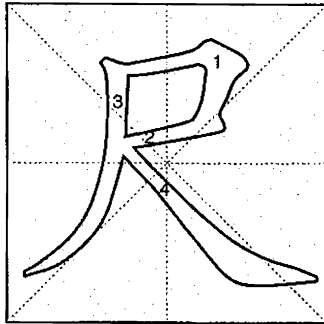

尺 chǐ 193

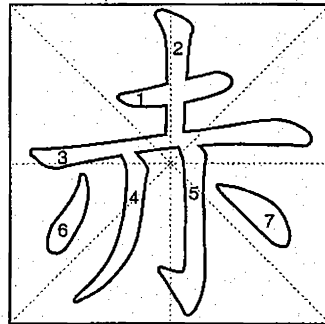

赤 chì 194

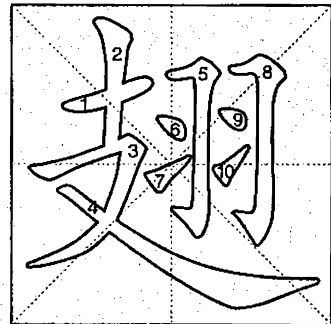

翅 chì 195

### 诚 chéng

sincere; honest  
 诚恳 chéng'kěn  
 sincere  
 诚实 chéng'shí  
 honest  
 诚心 chéng'xīn  
 sincere desire

### 乘 chéng

① ride ② take advantage of;  
 avail oneself of ③ multiply  
 乘客 chéng'kè  
 passenger  
 乘凉 chéng'liáng  
 enjoy the cool  
 乘坐 chéng'zuò  
 ride

### 程 chéng

rule; order; journey; distance  
 程度 chéng'dù  
 level; degree  
 程控 chéng'kòng  
 program control  
 程序 chéng'xù  
 order; procedure; course

### 呈 chéng

① assume ② submit; present  
 ③ petition; memorial  
 呈报 chéng'bào  
 submit a report  
 呈送 chéng'sòng  
 present; submit  
 呈现 chéng'xiàn  
 present; appear

### 城 chéng

① city wall; wall ② city; town  
 城门 chéng'mén  
 city gate  
 城墙 chéng'qiáng  
 city wall  
 城市 chéng'shì  
 town; city

### 池 chí

① pool; pond  
 ② stalls (in a theatre)  
 池塘 chí'táng  
 pond; pool

### 匙 chí

spoon

### 持 chí

① hold; grasp ② support; maintain  
 ③ manage; run ④ oppose  
 持家 chí'jiā  
 run one's home  
 持枪 chí'qiāng  
 hold a gun; port arms  
 持有 chí'yǒu  
 hold

### 吃 chī

① eat; take ② have one's meals  
 ③ live on ④ suffer; incur  
 吃饱 chī'bǎo  
 eat one's fill; be full  
 吃苦 chī'kǔ  
 bear hardships  
 吃亏 chī'kuī  
 suffer losses

### 承 chéng

① bear; hold; carry ② undertake;  
 contract(to do a job) ③ be indebted  
 ④ continue; carry on  
 承办 chéng'bàn  
 undertake  
 担当 chéng'dāng  
 take; bear  
 承认 chéng'rèn  
 admit; acknowledge

### 翅 chì

① wing ② shark's fin  
 翅膀 chì'pǎng  
 wing

### 赤 chì

① red ② loyal; sincere  
 ③ bare  
 赤道 chì'dào  
 the equator  
 赤脚 chì'jiǎo  
 barefoot  
 赤金 chì'jīn  
 pure gold

### 尺 chǐ

① chǐ, a unit of length(=1/3 me-  
 tre) ② rule; ruler  
 尺寸 chǐ'cun  
 measurement; size  
 尺码 chǐ'mǎ  
 size; measures  
 尺子 chǐ'zi  
 rule; ruler

### 齿 chǐ

tooth  
 齿轮 chǐ'lún  
 gear wheel; gear  
 齿龈 chǐ'yīn  
 gums

### 迟 chí

① slow; tardy ② late  
 迟到 chí'dào  
 be late; arrive late  
 迟钝 chí'dùn  
 slow (in thought); obtuse  
 迟误 chí'wù  
 delay; procrastinate





### 重 chóng

- ①repeat ②again; once more  
③layer  
重版 chóng'bǎn  
republication  
重播 chóng'bō  
rebroadcast  
重返 chóng'fǎn  
return

### 虫 chóng

- insect; worm  
虫害 chóng'hài  
insect pest  
虫牙 chóng'yá  
carious tooth  
虫灾 chóng'zāi  
plague of insects

### 冲 chōng

- ①pour boiling water on  
②rinse; flush  
冲动 chōng'dòng  
impulse; get excited  
冲浪 chōng'làng  
surfing; surfing riding  
冲洗 chōng'xǐ  
rinse; wash; develop

### 充 chōng

- ①sufficient; full ②fill; charge  
③serve as; act as  
④pose as; pass sth. off as  
充电 chōng'diàn  
charge (a battery)  
充分 chōng'fèn  
full; ample; abundant  
充足 chōng'zú  
adequate; sufficient

### 斥 chì

- ①upbraid; scold; reprimand  
②repel; exclude; oust  
斥骂 chì'mà  
reproach  
斥责 chì'zé  
rebuke; excoriate  
斥资 chì'zī  
pay

### 愁 chóu

- worry; be anxious  
愁苦 chóu'kǔ  
anxiety; distress  
愁闷 chóu'mèn  
feel gloomy; be depressed  
愁容 chóu'róng  
worried look

### 酬 chóu

- ①reward; payment ②fulfill  
酬报 chóu'bào  
requite; repay  
酬金 chóu'jīn  
monetary reward  
酬谢 chóu'xiè  
thank sb. with a gift

### 抽 chōu

- ①take out (from in between)  
②take (a part from a whole)  
③(of certain plants) put forth  
抽奖 chōu'jiǎng  
draw a lottery  
抽税 chōu'shuì  
levy a tax  
抽屉 chōu'ti  
drawer

### 冲 chòng

- ①with plenty of dash; vigorously  
②(of smell) strong  
③facing; towards  
冲床 chòng'chuáng  
punch  
冲压 chòng'yā  
punching

### 崇 chóng

- ①high; lofty; sublime  
②esteem; worship  
崇拜 chóng'bài  
adore  
崇高 chóng'gāo  
lofty; sublime; high  
崇敬 chóng'jìng  
respect; revere

### 出 chū

- ①go or come out ②exceed; go beyond ③issue; put up ④produce; turn out  
出版社 chū'bǎn'shè  
publishing house; press  
出错 chū'cuò  
make mistakes  
出点子 chū'diǎn'zi  
offer advice

### 臭 chòu

- ①smelly; foul; stinking  
②disgusting; disgraceful  
臭虫 chòu'chóng  
bedbug  
臭味 chòu'wèi  
stink; offensive odor  
臭氧(化) chòu'yǎng(huà)  
ozone

### 丑 chǒu

- ①ugly; unsightly  
②disgraceful; shameful; scandalous  
丑恶 chǒu'è  
ugly; repulsive; hideous  
丑态 chǒu'tài  
ugly performance  
丑闻 chǒu'wén  
scandal

### 绸 chóu

- silk fabric; silk  
绸缎 chóu'duàn  
silks and satins  
绸缪 chóu'móu  
sentimentally attached  
绸子 chóu'zi  
silk fabric

### 仇 chóu

- ①enemy; foe ②hatred; enmity  
仇敌 chóu'dī  
foe; enemy  
仇恨 chóu'hèn  
hatred; enmity; hostility  
仇人 chóu'rén  
personal enemy

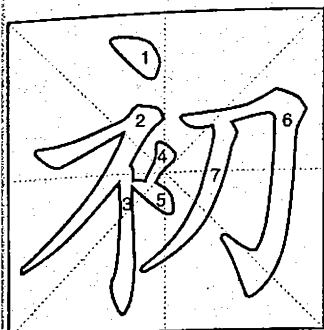

初 chū 211

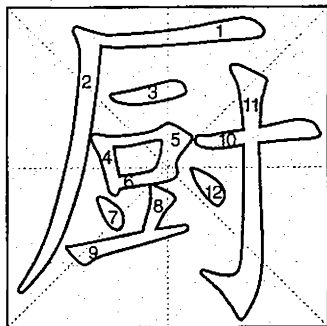

厨 chú 212

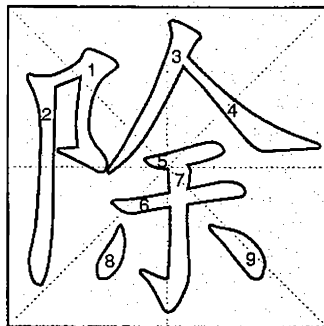

除 chú 213

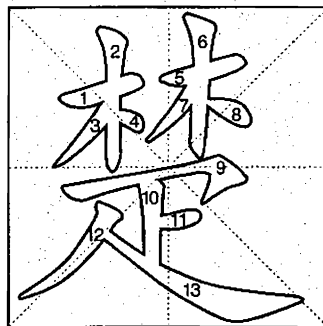

楚 chǔ 214

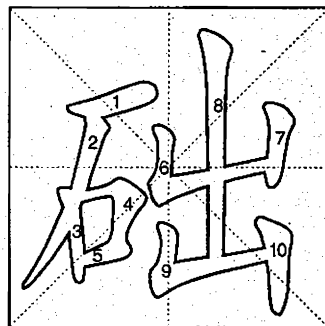

础 chǔ 215

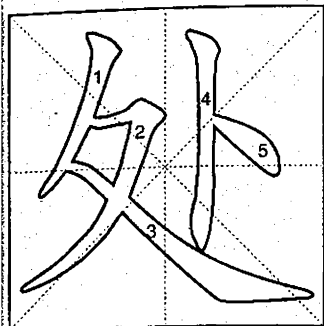

处 chǔ 216

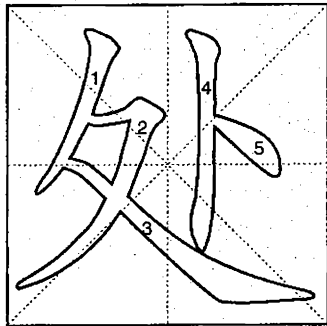

处 chù 217

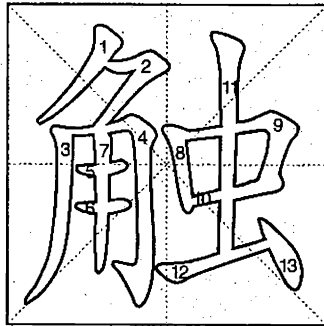

触 chù 218

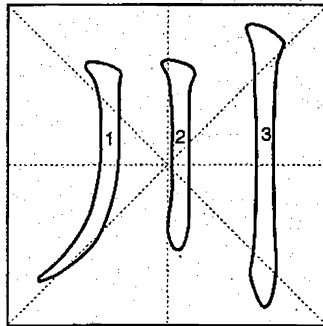

川 chuān 219

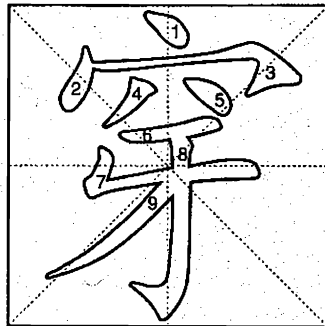

穿 chuān 220

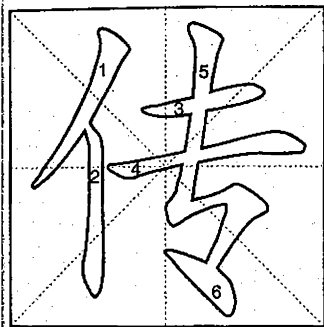

传 chuán 221

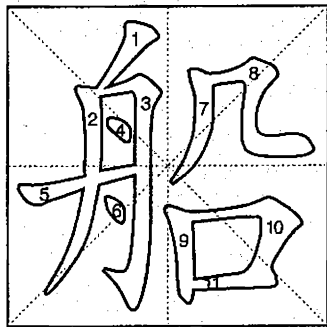

船 chuán 222

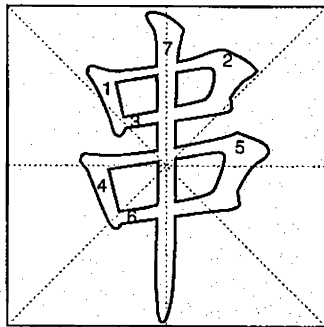

串 chuàn 223

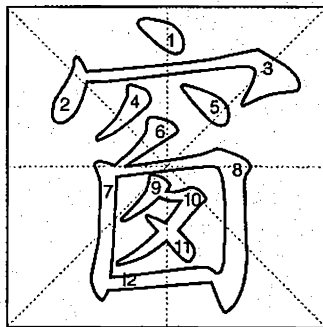

窗 chuāng 224

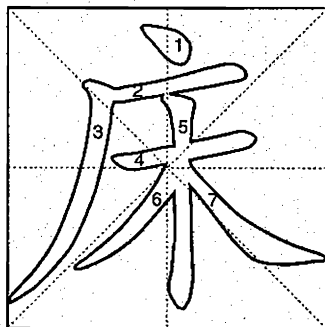

床 chuáng 225

**础 chǔ**

plinth  
基础 jī'chǔ  
foundation  
础石 chǔ'shí  
the stone base of a column

**楚 chǔ**

①clear; neat  
②pang; suffering  
楚楚动人 chǔ'chǔ'dòng'rén  
lovingly pathetic

**除 chú**

①get rid of; eliminate; remove  
②except ③besides ④divide  
除草 chú'cǎo  
weeding  
除外 chú'wài  
except; not counting  
除夕 chú'xī  
New Year's Eve

**厨 chú**

kitchen  
厨房 chú'fáng  
kitchen  
厨师 chú'shī  
cook; chef

**初 chū**

①at the beginning of; in the early part of ②first(in order)  
③for the first time ④elementary; rudimentary ⑤original  
初版 chū'bǎn  
first edition  
初次 chū'cì  
the first time  
初审 chū'shěn  
first trial

**穿 chuān**

①pierce through; penetrate  
②pass through; cross ③wear; be dressed in  
穿行 chuān'xíng  
pass through  
穿针 chuān'zhēn  
thread a needle  
穿着 chuān'zhuó  
dress; apparel

**川 chuān**

①river ②plain  
川流不息 chuān'liú'bù'xī  
never-ending  
川资 chuān'zī  
travelling expenses

**触 chù**

①touch; contact ②strike; hit  
③move sb.; stir up sb.'s feelings  
触电 chù'diàn  
get an electric shock  
触及 chù'jí  
touch  
触礁 chù'jiāo  
run (up) on rocks

**处 chù**

①place ②point; part  
③department; office  
处处 chù'chù  
everywhere; in all respects  
处所 chù'suǒ  
place; location  
处长 chù'zhǎng  
department chief

**处 chǔ**

①get along(with sb.) ②be situated in; be in a certain condition  
③manage; handle; deal with  
④punish; sentence ⑤dwell; live  
处方 chǔ'fāng  
prescribe  
处分 chǔ'fèn  
punish  
处理 chǔ'lǐ  
handle; deal with

**床 chuáng**

bed  
床单 chuáng'dān  
sheet  
床铺 chuáng'pù  
bed  
床罩 chuáng'zhào  
bedspread; counterpane

**窗 chuāng**

window  
窗户 chuāng'hù  
window; casement  
窗帘 chuāng'lián  
curtain  
窗纱 chuāng'shā  
window screening

**串 chuàn**

①string together ②conspire  
③get things mixed up ④run about;  
rove ⑤play a part (in a play)  
串门儿 chuàn'mén'er  
call at sb.'s home  
串通 chuàn'tōng  
gang up; collaborate  
串音 chuàn'yīn  
crosstalk; overhear

**船 chuán**

boat; ship  
船厂 chuán'chǎng  
shipyard; dockyard  
船工 chuán'gōng  
boatman; junkman  
船长 chuán'zhǎng  
captain; skipper

**传 chuán**

①pass (on) ②hand down ③pass on (knowledge, skill, etc.); impart  
④spread  
传达室 chuán'dá'shì  
reception office  
传教士 chuán'jiào'shì  
missionary  
传统 chuán'tǒng  
tradition

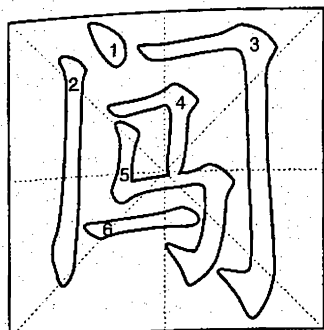

闯 chuǎng

226

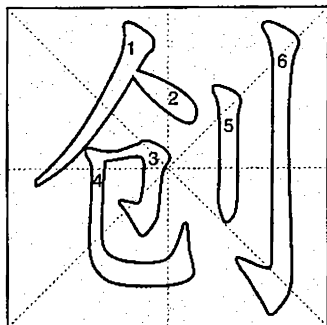

创 chuàng

227

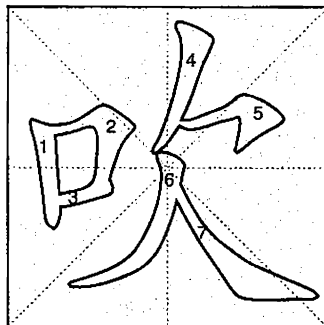

吹 chuī

228

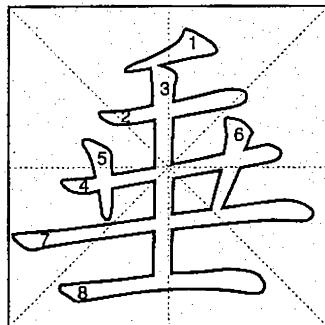

垂 chuí

229

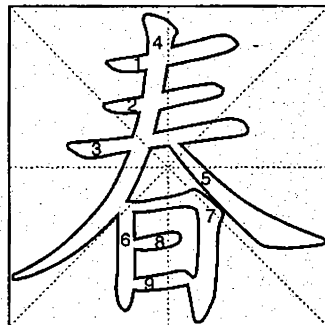

春 chūn

230

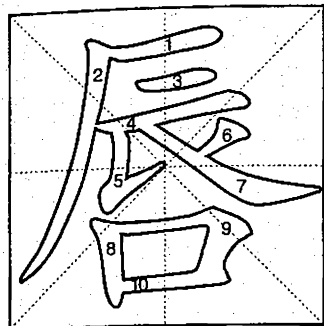

唇 chún

231

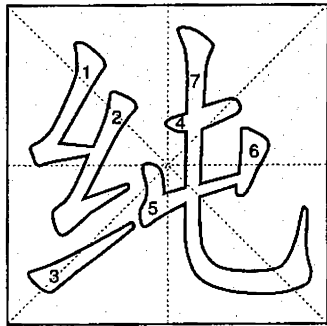

纯 chún

232

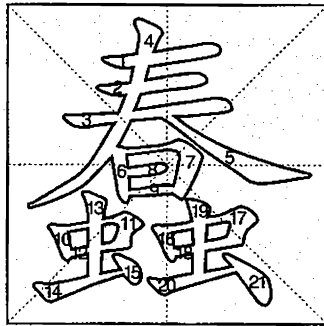

蠢 chǔn

233

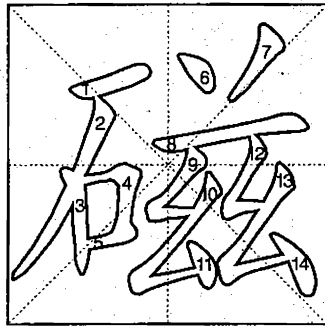

磁 cí

234

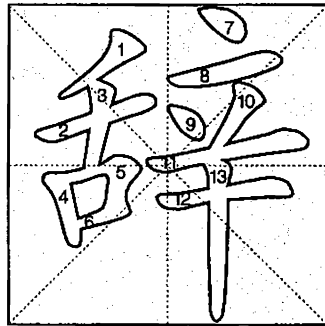

辞 cí

235

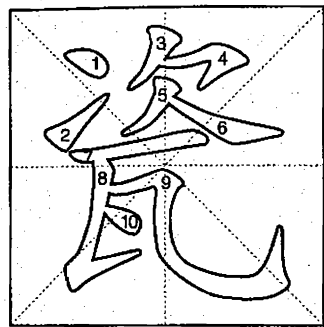

瓷 cí

236

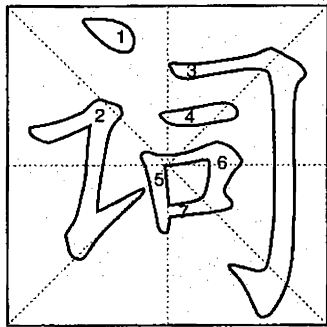

词 cí

237

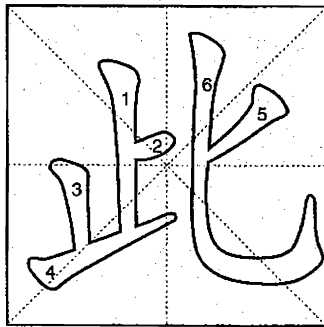

此 cǐ

238

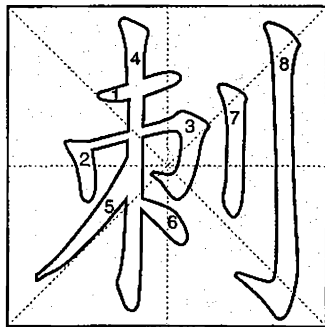

刺 cì

239

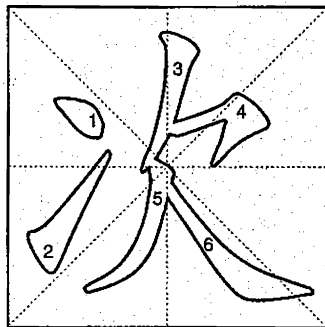

次 cì

240

### 春 chūn

①spring ②love; lust ③life vitality

春风 chūn'fēng

spring breeze

春假 chūn'jià

spring vacation

春节 chūn'jié

The Spring Festival

### 垂 chuí

hang down; droop; let fall

垂钓 chuí'diào

go angling

垂危 chuí'wēi

at one's last gasp

垂涎 chuí'xián

drool; slaver; covet

### 吹 chuī

①blow; puff ②play (wind instruments) ③boast; brag ④break off; break up; fall through

吹号 chuī'hào

blow a bugler

吹牛 chuī'niú

boast; brag; talk big

吹奏 chuī'zòu

play (wind instruments)

### 创 chuàng

start (doing sth.); achieve (sth. for the first time)

创办 chuàng'bàn

establish; set up; found

创刊号 chuàng'kān'hào

first issue

创收 chuàng'shōu

make extra earning

### 闯 chuǎng

①rush; dash; charge ②tempt oneself (by battling through difficulties and dangers)

闯祸 chuǎng'huò

get into trouble

闯劲 chuǎng'jìng

pioneering spirit

闯入 chuǎng'rù

burst into; intrude

### 辞 cí

①diction; phraseology ②take leave ③decline: ~让 politely decline ④dismiss

辞典 cí'diǎn

dictionary

辞退 cí'tuì

dismiss; discharge

辞职 cí'zhí

resign

### 磁(物) cí(wù)

magnetism

磁带 cí'dài

(magnetic) tape

磁盘 cí'pán

disc; magnetic disc

磁铁 cí'tiě

magnet

### 蠢 chǔn

stupid; foolish; dull; clumsy

蠢材 chǔn'cái

idiot; fool; blockhead

蠢货 chǔn'huò

blockhead; dunce; idiot

蠢人 chǔn'rén

fool; blockhead

### 纯 chún

①pure; unmixed ②simple

纯度 chún'dù

purity; pureness

纯利 chún'lì

net profit

纯收入 chún'shōurù

net income

### 唇 chún

lip

唇齿相依 chún'chǐ'xiāng'yī

be as close as lips and teeth

唇膏 chún'gāo

lipstick

唇枪舌战 chún'qiāng'shé'zhàn

cross verbal swords

### 次 cì

①order; sequence ②second; next ③second-rate; inferior ④time

次等 cì'děng

second-class; inferior

次货 cì'huò

inferior goods

次品 cì'pǐn

substandard products

### 刺 cì

①thorn; splinter ②stab; prick ③assassinate ④irritate; stimulate

⑤criticize

刺刀 cì'dāo

bayonet

刺激 cì'jī

stimulate; provoke

刺客 cì'kè

assassin

### 此 cǐ

this

此地 cǐ'dì

this place; here

此后 cǐ'hòu

after this; hereafter

此间 cǐ'jiān

around here; here

### 词 cí

①word; term

②speech; statement

词典 cí'diǎn

dictionary

词汇 cí'huì

vocabulary

词组 cí'zǔ

word group; phrase

### 瓷 cí

porcelain; china

瓷器 cí'qì

chinaware

瓷实 cí'shí

solid; firm; substantial

瓷碗 cí'wǎn

china bowl

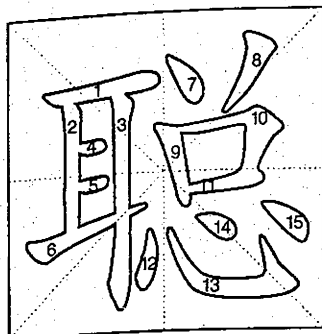

聪 cōng 241

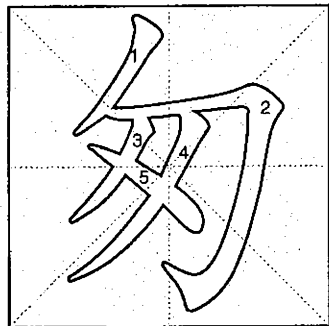

匆 cōng 242

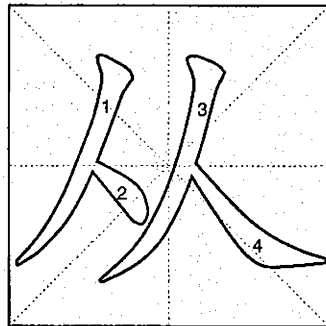

从 cóng 243

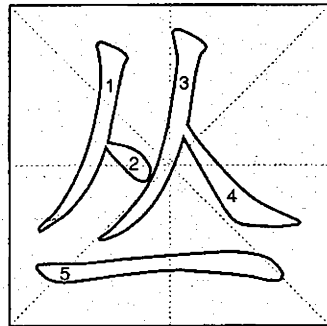

丛 cóng 244

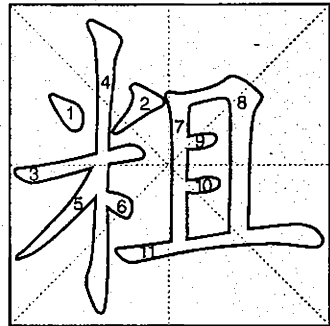

粗 cū 245

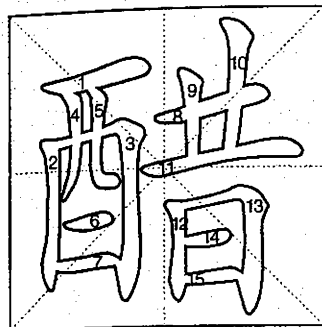

醋 cù 246

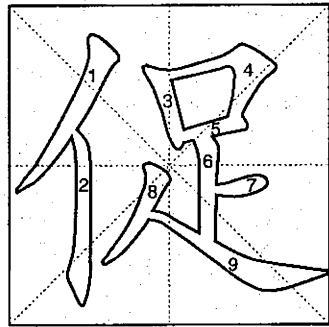

促 cù 247

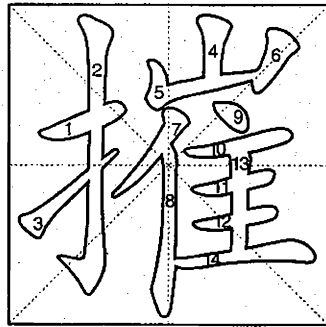

摧 cuī 248

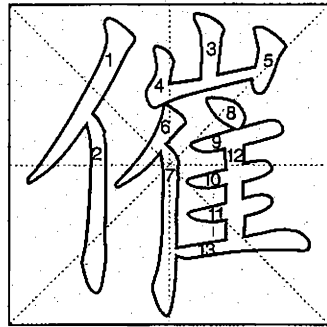

催 cuī 249

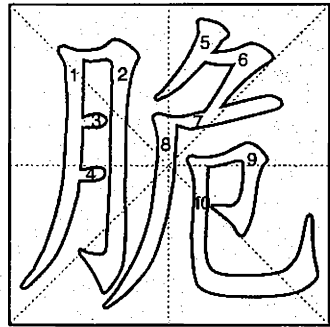

脆 cuì 250

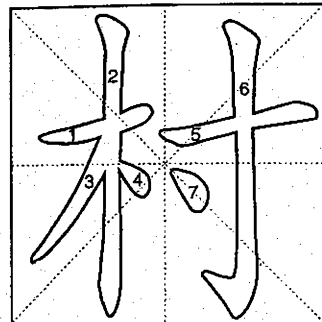

村 cūn 251

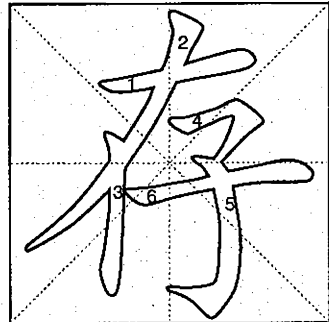

存 cún 252

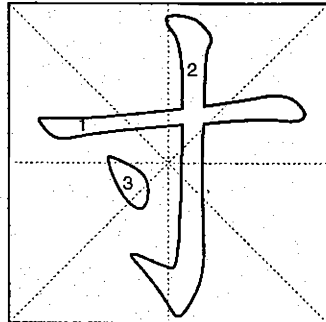

寸 cùn 253

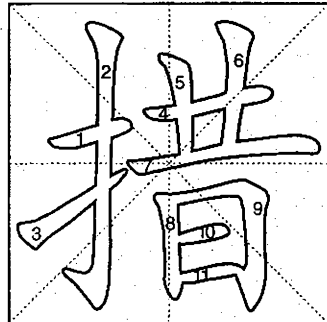

措 cuò 254

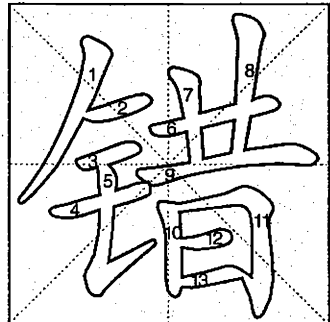

错 cuò 255

### 粗 cū

①wide (in diameter); thick  
 ②crude; rough ③gruff; husky  
 ④careless; negligent ⑤rude; unre-  
 fined; vulgar ⑥roughly; slightly  
 粗大 cū'dà  
 thick; bulky  
 粗加工 cū'jiā'gōng  
 rough finish  
 粗鲁 cū'lǔ  
 rude; boorish

### 丛 cóng

①clump; thicket; grove  
 ②crowd; collection  
 丛林 cóng'lín  
 jungle; forest  
 丛生 cóng'shēng  
 (of plants) grow thickly  
 丛书 cóng'shū  
 a series of books

### 从 cóng

①from; through ②follow; com-  
 ply with; obey ③join; be engaged  
 in ④follower; attendant; retinue  
 ⑤secondary  
 从此 cóng'cǐ  
 from now on  
 从军 cóng'jūn  
 join the army; enlist  
 从事 cóng'shì  
 go in for; be engaged in

### 匆 cōng

hastily  
 匆匆 cōng'cōng  
 hurriedly; in a rush  
 匆促 cōng'cù  
 hastily; in a hurry  
 匆忙 cōng'máng  
 hastily; in a hurry

### 聪 cōng

faculty of hearing; acute hearing  
 聪慧 cōng'huì  
 bright; intelligent  
 聪明 cōng'míng  
 intelligent; bright  
 聪颖 cōng'yǐng  
 intelligent; bright

### 脆 cuì

①fragile; brittle ②crisp  
 ③(of voice) clear  
 脆弱 cuì'ruò  
 fragile; frail; weak

### 催 cuī

①urge; press ②speed up  
 催办 cuī'bàn  
 hasten sb. to do sth.  
 催促 cuī'cù  
 urge; hasten; press  
 催眠 cuī'mián  
 lull (to sleep)

### 摧 cuī

break; destroy; ruin  
 摧残 cuī'cán  
 wreck; destroy  
 摧毁 cuī'huǐ  
 destroy; smash; wreck

### 促 cù

①(of time) short; hurried; urgent  
 ②urge; promote ③close to; near  
 促成 cù'chéng  
 help to bring about  
 促进 cù'jìn  
 promote; advance  
 促销 cù'xiāo  
 promote sales

### 醋 cù

①vinegar ②jealousy (as in lo-  
 affair)  
 醋意 cù'yì  
 jealousy

### 错 cuò

①intricate; complex ②grind  
 (one's teeth, etc.); rub ③alternate  
 ④wrong; mistaken ⑤fault; demerit  
 ⑥bad; poor  
 错觉 cuò'jué  
 illusion; misconception  
 错误 cuò'wù  
 wrong; mistake  
 错字 cuò'zì  
 misprint

### 措 cuò

①arrange; manage; handle  
 ②make plans  
 措辞 cuò'cí  
 wording; diction  
 措施 cuò'shī  
 measure; step  
 措手不及 cuò'shǒu'bù'jí  
 be caught unawares

### 寸 cùn

①cun, a unit of length (= 1/3  
 decimetre) ②very little; very short;  
 small  
 寸步不离 cùn'bù'bù'lí  
 follow sb. closely  
 寸步不让 cùn'bù'bù'ràng  
 refuse to yield an inch  
 寸步难行 cùn'bù'nán'xíng  
 difficult to move even one step

### 存 cún

①exist; live; survive ②store;  
 keep ③accumulate; collect ④de-  
 posit (money) ⑤leave with  
 存单 cún'dān  
 deposit receipt  
 存折 cún'zhé  
 deposit book; bankbook  
 存盘 cún'pán  
 save information on a disk

### 村 cūn

①village; hamlet  
 ②rustic; boorish  
 村落 cūn'luò  
 village hamlet  
 村民 cūn'mín  
 villager  
 村镇 cūn'zhèn  
 villages and towns

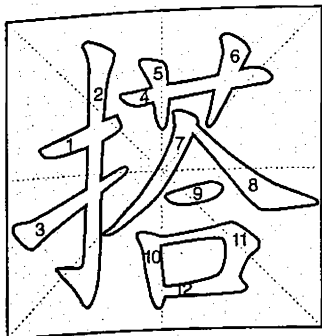

搭 dā 256

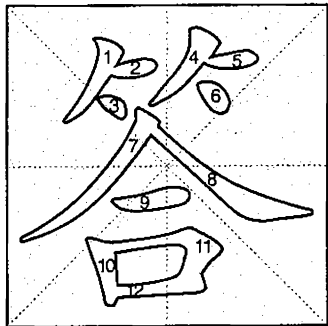

答 dā 257

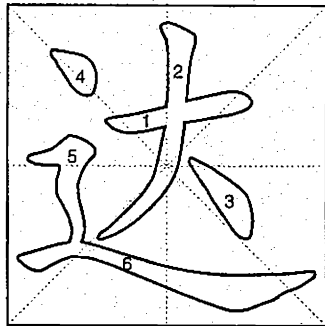

达 dá 258

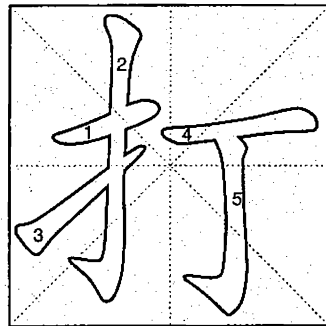

打 dǎ 259

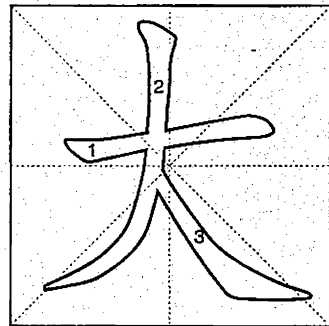

大 dà 260

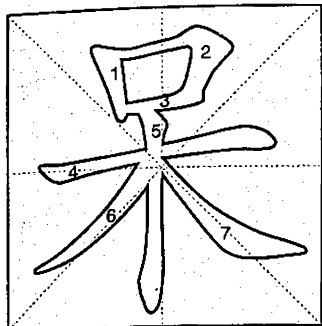

呆 dāi 261

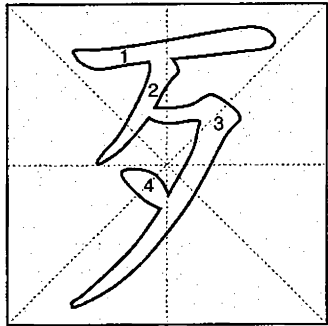

歹 dǎi 262

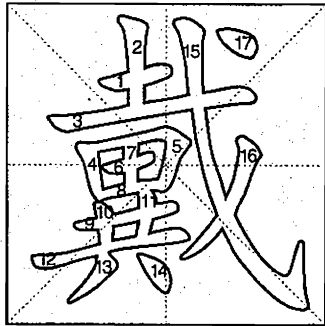

戴 dài 263

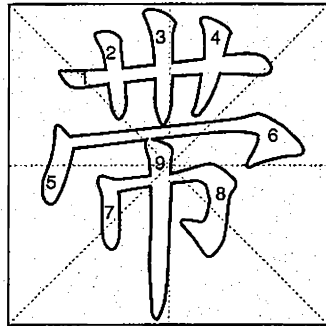

带 dài 264

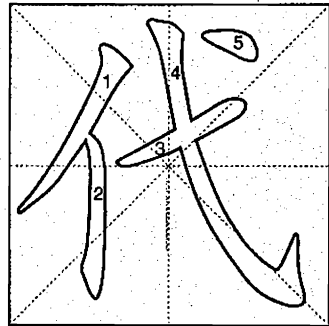

代 dài 265

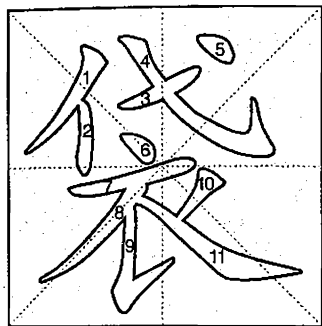

袋 dài 266

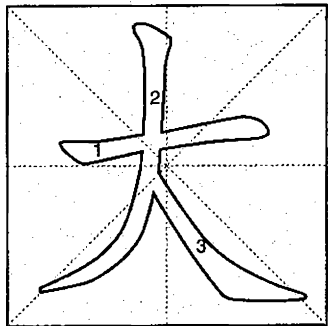

大 dà 267

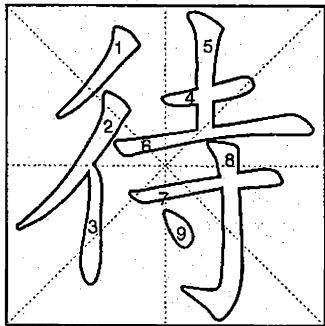

待 dài 268

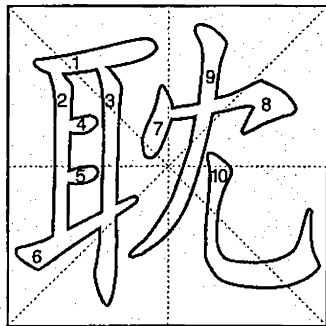

耽 dān 269

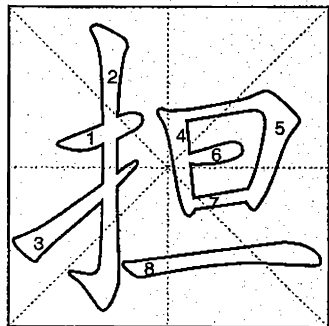

担 dān 270



### 大 dà

① big ; large; great ② heavy (rain, etc.); strong (wind, etc.)  
 ③ loud ④ general; main; major  
 ⑤ greatly; fully ⑥ eldest  
 大白菜 dà'bái'cài  
 Chinese cabbage  
 大百科全书 dà'bǎi'kē'quán'shū  
 encyclopedia  
 大地 dà'dì  
 the earth

### 打 dǎ

① strike; hit; beat; break ② build; make; open ③ tie up; pack; weave; draw; put a mark on; spread; raise; remove  
 打败 dǎ'bài  
 defeat; beat; worst  
 打扮 dǎ'bàn  
 dress up; make up  
 打火机 dǎ'huǒ'jī  
 lighter; cigarette lighter

### 达 dá

① extend ② reach; amount to ③ express; communicate ④ eminent; distinguished  
 达成 dá'chéng  
 reach (an agreement)  
 达旦 dá'dàn  
 until dawn  
 达到 dá'dào  
 achieve; attain; reach

### 答 dā

答茬儿 dā'chá'ér  
 pick up one's words and take part in a conversation  
 答理〈否定〉 dǎ'li〈fǒu'dìng〉  
 respond; answer  
 答应 dǎ'yīng  
 answer; reply; promise

### 搭 dā

① put up; build ② hang over; over ③ come into contact; join ④ throw in more (people, money, etc.)  
 add  
 搭乘 dā'chéng  
 travel by  
 搭救 dā'jiù  
 rescue; help  
 搭桥 dā'qiáo  
 set up bridges

### 代 dài

① take the place of ② acting ③ historical period ④ generation  
 代号 dài'hào  
 code name  
 代价 dài'jià  
 price; cost; sacrifice  
 代码 dài'mǎ  
 code

### 带 dài

① belt; ribbon; band; tape; sash; girdle ② zone; area; belt ③ take; bring carry; bear; have; lead; head; do sth. incidentally  
 带路 dài'lù  
 show the way  
 带头 dài'tóu  
 take the lead  
 带信儿 dài'xìn'er  
 bring a message

### 戴 dài

① put on; wear ② love and respect ③ Dai (姓) a surname  
 戴绿帽子 dài'lǜ'mào'zi  
 be a cuckold  
 戴帽子 dài'mào'zi  
 wear one's hat  
 戴孝 dài'xiào  
 wear mourning for a person

### 歹 dǎi

bad; evil; vicious  
 歹徒 dǎi'tú  
 scoundrel; ruffian

### 呆 dāi

① slow-witted; dull ② blank; wooden ③ stay  
 呆板 dāi'bǎn  
 stiff; inflexible; rigid  
 呆滞 dāi'zhì  
 dull; inert; sluggish  
 呆子 dāi'zi  
 idiot; simpleton

### 担 dān

① carry on a shoulder pole ② take on; undertake  
 担保 dān'bǎo  
 guarantee; vouch for  
 担心 dān'xīn  
 worry; feel anxious  
 担忧 dān'yōu  
 be anxious

### 耽 dān

① delay ② indulge in (pleasure, etc.)  
 耽搁 dān'ge  
 stop over; stay; delay  
 耽误 dān'wù  
 delay; hold up  
 耽于 dān'yú  
 addict; indulge in

### 待 dài

① treat; deal with ② entertain ③ wait for; await  
 待客 dài'kè  
 entertain a guest  
 待命 dài'mìng  
 await for orders  
 待业 dài'yè  
 unemployment

### 大 dài

大夫 dài'fū  
 doctor; physician

### 袋 dài

bag; sack; pocket; pouch  
 袋鼠 dài'shū  
 kangaroo  
 袋装 dài'zhuāng  
 in bags  
 袋子 dài'zi  
 sack; bag

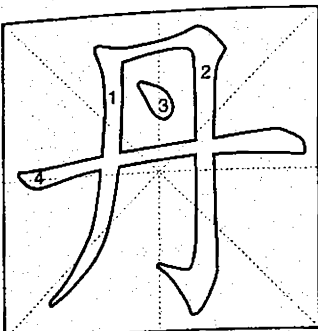

丹 dān 271

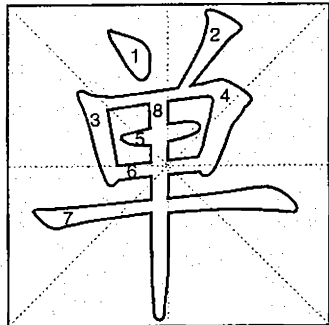

单 dān 272

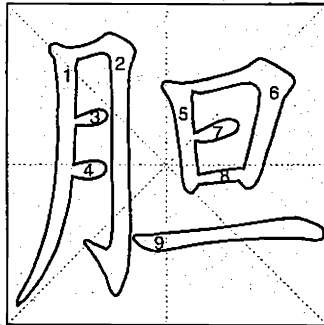

胆 dǎn 273

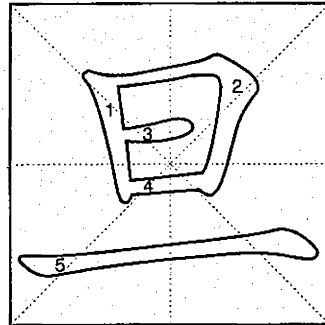

旦 dàn 274

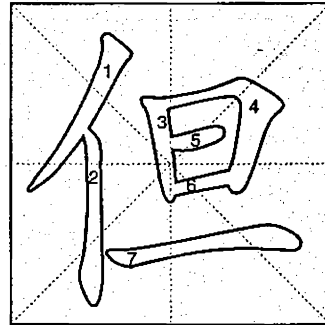

但 dàn 275

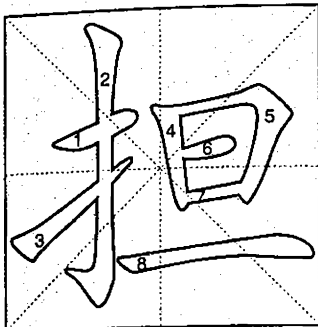

担 dàn 276

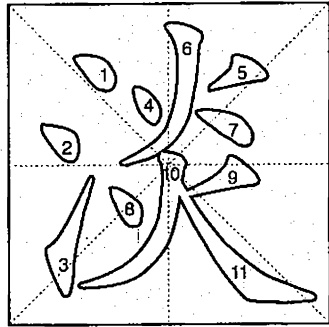

淡 dàn 277

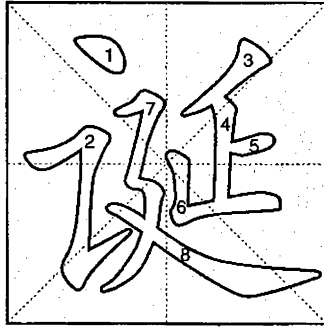

诞 dàn 278

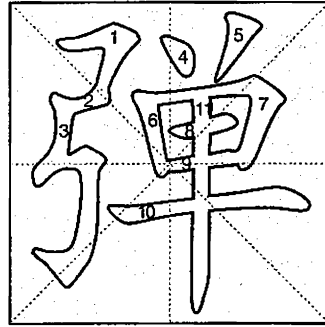

弹 dàn 279

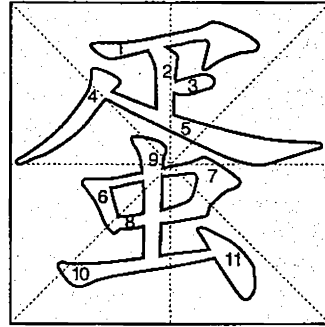

蛋 dàn 280

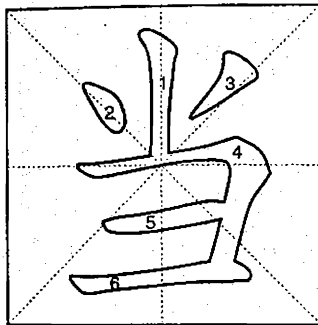

当 dāng 281

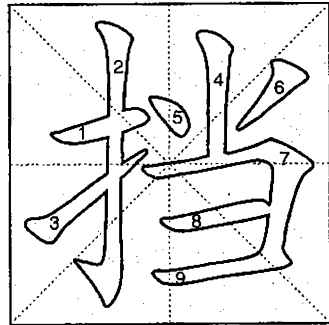

挡 dǎng 282

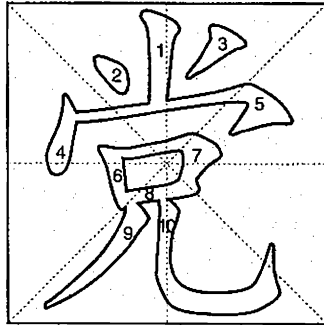

党 dǎng 283

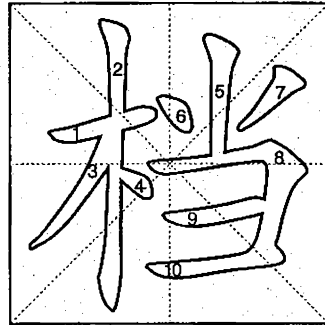

档 dàng 284

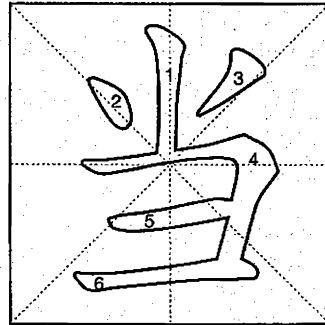

当 dàng 285

### 但 dàn

- ①but ②only; merely  
 但凡 dàn'fán  
 in every case  
 但是 dàn'shì  
 but; yet; still  
 但愿 dàn'yuàn  
 if only; I wish

### 旦 dàn

- ①dawn; daybreak ②day

### 胆 dǎn

- ①gallbladder ②courage; guts;  
 bravery  
 胆大 dǎn'dà  
 bold; audacious  
 胆敢 dǎn'gǎn  
 dare  
 胆小 dǎn'xiǎo  
 timid; cowardly

### 单 dān

- ①one; single ②odd ③single;  
 alone; only ④unlined (clothing)  
 ⑤sheet ⑥bill; list  
 单价 dān'jià  
 unit price  
 单身 dān'shēn  
 unmarried; single  
 单位 dān'wèi  
 unit

### 丹 dān

- ①red ②pellet or powder  
 丹顶鹤 dān'dǐng'hè  
 red-crowned crane  
 丹方 dān'fāng  
 folk prescription  
 丹心 dān'xīn  
 a loyal heart; loyalty

### 蛋 dàn

- egg  
 蛋糕 dàn'gāo  
 cake  
 蛋羹 dàn'gēng  
 egg custard  
 蛋黄 dàn'huáng  
 yolk

### 弹 dàn

- ①ball; pellet ②bullet; bomb  
 弹弓 dàn'gōng  
 catapult  
 弹壳 dàn'hé  
 shell case  
 弹药 dàn'yào  
 ammunition

### 诞 dàn

- ①birth ②birthday ③absurd;  
 fantastic  
 诞辰 dàn'chén  
 birthday  
 诞生 dàn'shēng  
 be born; emerge

### 淡 dàn

- ①thin; light ②tasteless; weak  
 ③light; pale ④indifferent ⑤slack;  
 dull  
 淡季 dàn'jì  
 slack season  
 淡色 dàn'sè  
 light colour  
 淡水 dàn'shuǐ  
 fresh water

### 担 dàn

- ①a unit of weight(=50kgs) (量)  
 a load of  
 担子 dàn'zi  
 burden; load

### 当 dāng

- ①proper; right ②match; equal  
 to ③treat as; regard as; take for  
 ④think  
 当年 dāng'nián  
 the same year  
 当铺 dāng'pù  
 pawnshop  
 当时 dāng'shí  
 right away; immediately

### 档 dàng

- ①shelves (for files); pigeonholes  
 ②files; archives  
 ③crosspiece (of a table)  
 档案 dàng'àn  
 files; archives  
 档次 dàng'cì  
 grade; class; differential  
 档期 dàng'qī  
 (of films or television programmes)  
 slot; time or season to be shown

### 党 dǎng

- ①political party; party ②clique;  
 gang ③relative; kinsfolk  
 党报 dǎng'bào  
 party newspaper  
 党派 dǎng'pài  
 parties; party cliques  
 党员 dǎng'yuán  
 party member

### 挡 dǎng

- ①keep off; ward off; block  
 ②get in the way of  
 ③fender; blind ④gear  
 挡风 dǎng'fēng  
 shelter from the wind  
 挡路 dǎng'lù  
 be in the way  
 挡雨 dǎng'yǔ  
 keep off the rain

### 当 dāng

- ①equal ②ought; should; mu  
 ③in sb.'s presence ④just at (time or place) ⑤work as; serve as; b  
 当班 dāng'bān  
 be on duty  
 当兵 dāng'bīng  
 serve in the army  
 当地 dāng'dì  
 local

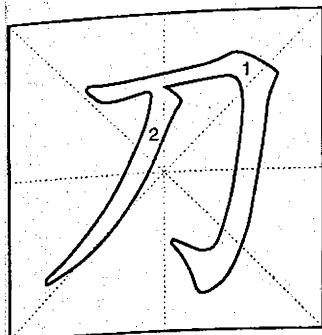

刀 dāo 286

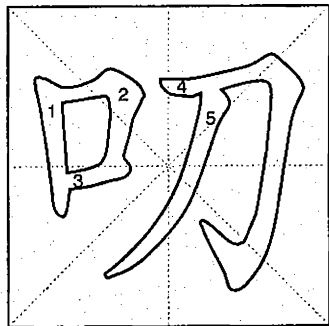

叨 dāo 287

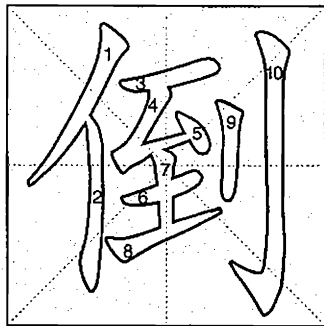

倒 dǎo 288

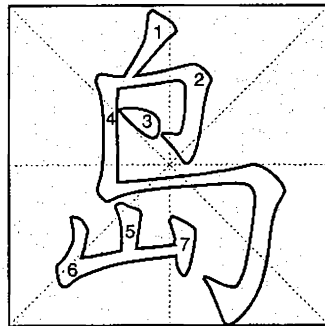

岛 dǎo 289

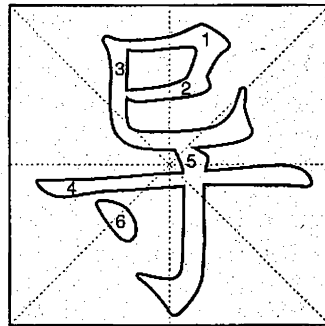

导 dǎo 290

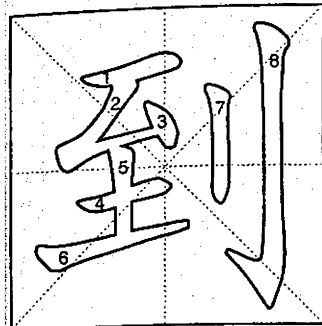

到 dào 291

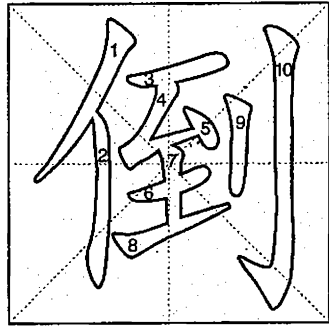

倒 dào 292

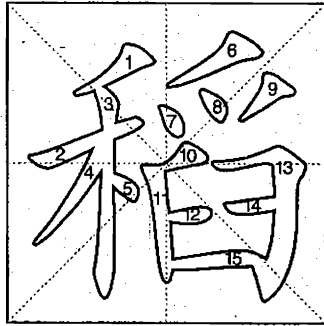

稻 dào 293

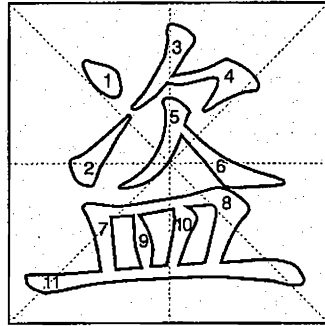

盗 dào 294

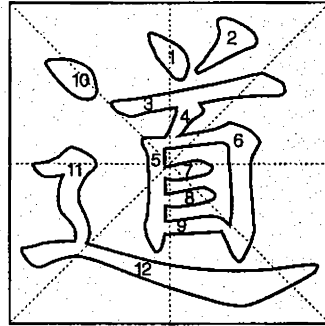

道 dào 295

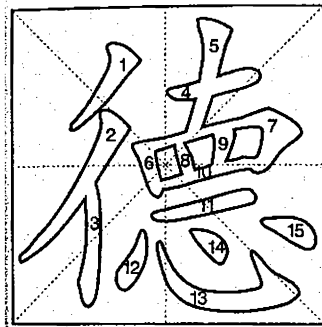

德 dé 296

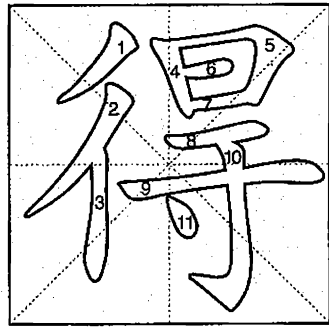

得 dé 297

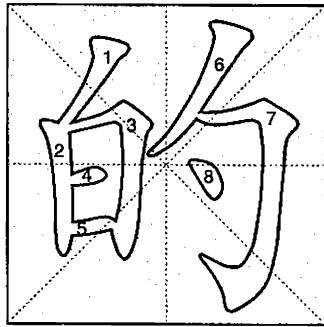

的 de 298

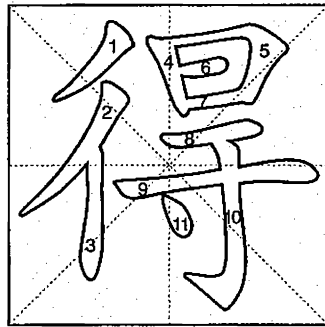

得 de 299

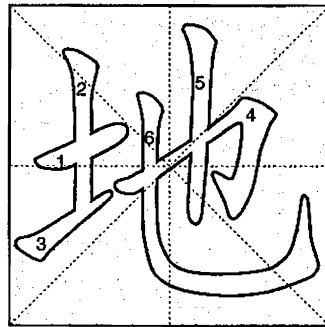

地 de 300

### 导 dǎo

①lead; guided ②transmit; conduct ③instruct; teach; give guidance to  
 导弹 dǎo'dàn  
 guided missile  
 导电 dǎo'diàn  
 electric conduction  
 导购 dǎo'gòu  
 shopping guide

### 岛 dǎo

island 半~ peninsula  
 岛国 dǎo'guó  
 island country  
 岛屿 dǎo'yǔ  
 islands and islets; islands

### 倒 dǎo

①fall; topple ②collapse; fail ③close down; go bankrupt; go out of business ④change; exchange  
 倒班 dǎo'bān  
 change shifts  
 倒闭 dǎo'bì  
 close down; go bankrupt  
 倒车 dǎo'chē  
 change trains (buses)

### 叨 dāo

叨唠 dāo'láo  
 talk on and on

### 刀 dāo

①knife; sword ②one hundred sheets (of paper)  
 刀叉 dāo'chā  
 knife and fork  
 刀片 dāo'piàn  
 razor blade  
 刀子 dāo'zi  
 small knife; pocketknife

### 道 dào

①road; way ②channel; course ③way; method ④doctrine; principle ⑤line  
 道岔 dào'chà  
 switches; points  
 道理 dào'lǐ  
 principle; truth; reason  
 道路 dào'lù  
 way; road; path

### 盗 dào

①steal; rob ②thief; robber  
 盗版 dào'bǎn  
 piracy; pirate; pirated  
 盗卖 dào'mài  
 steal and sell  
 盗窃 dào'qiè  
 steal

### 稻 dào

rice; paddy  
 稻草 dào'cǎo  
 rice straw  
 稻草人 dào'cǎo'rén  
 scarecrow  
 稻子 dào'zi  
 rice; paddy

### 倒 dào

①inverted; inverse ②move backward; turn upside down ③pour; tip  
 倒车 dào'chē  
 back a car  
 倒档 dào'dàng  
 reverse gear  
 倒数 dào'shù  
 count backwards

### 到 dào

①arrive; reach ②go to; leave for ③up until; up to  
 到处 dào'chù  
 everywhere  
 到达 dào'dá  
 arrive; reach; get to  
 到来 dào'lái  
 arrival; advent

### 地 de

used after an adverb

### 得 de

used after a verb or an adjective to express possibility of capability

### 的 de

used after an adjective

### 得 dé

①get; obtain; gain ②(of a calculation) result in ③fit; proper ④satisfied; complacent  
 得病 dé'bìng  
 fall ill; become sick  
 得分 dé'fēn  
 score  
 得主 dé'zhǔ  
 prizewinner; medalist

### 德 dé

①virtue; morals; moral character ②heart; mind ③kindness; favour  
 德国 dé'guó  
 Germany: ~人 German  
 德行 dé'xíng  
 moral integrity  
 德性 dé'xìng  
 disgusting; shameful

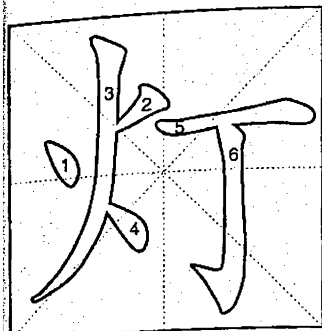

灯 dēng 301

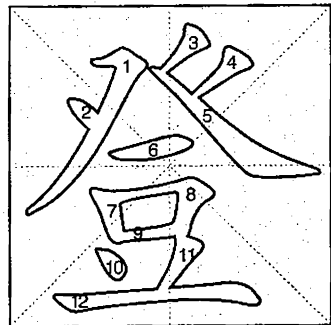

登 dēng 302

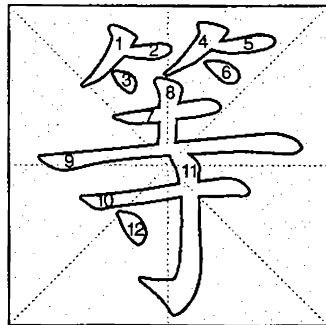

等 děng 303

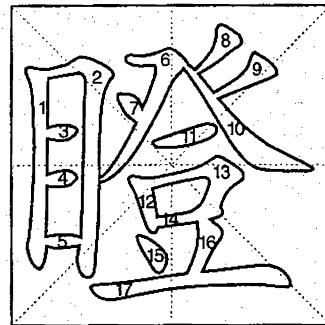

瞪 dèng 304

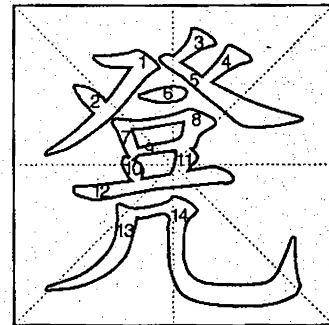

凳 dèng 305

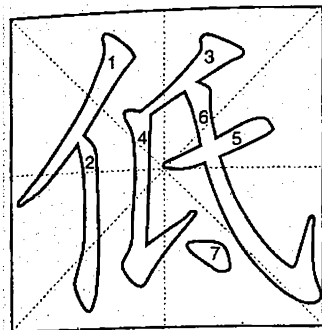

低 dī 306

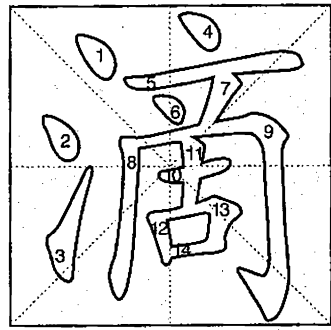

滴 dī 307

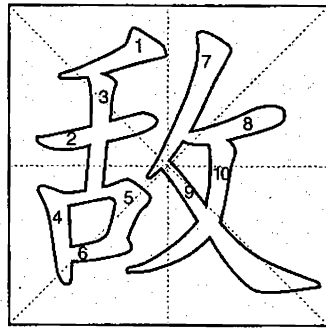

敌 dí 308

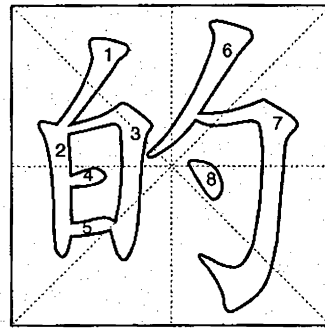

的 dí 309

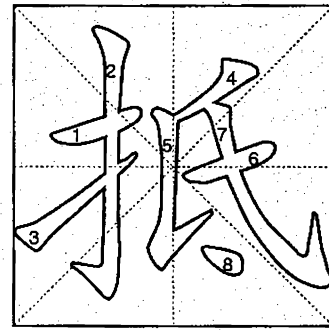

抵 dǐ 310

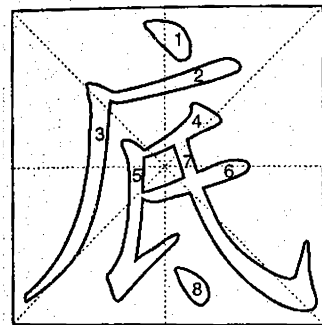

底 dǐ 311

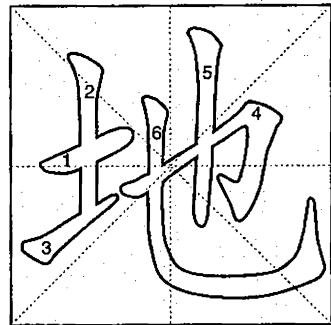

地 dì 312

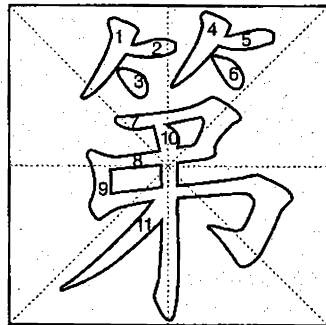

第 dì 313

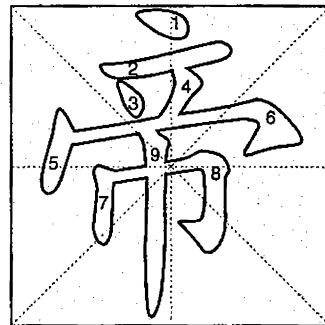

帝 dì 314

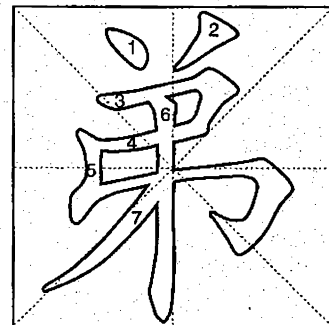

弟 dì 315

### 凳 dèng

stool; bench  
凳子 dèng'zi  
stool

### 瞪 dèng

open one's eyes wide; stare  
瞪眼 dèng'yǎn  
glower and glare at sb.

### 等 děng

①class; grade; rank ②equal  
③wait; await ④when; till ⑤and  
so on; and so forth; etc.  
等待 dēng'dài  
wait; await  
等级 dēng'jí  
grade; rank  
等同 dēng'tóng  
equate; be equal

### 登 dēng

①ascend; mount; scale (a height)  
②publish; record enter ③pedal;  
treadle ④step on; tread  
登广告 dēng'guǎng'gào  
advertise  
登机 dēng'jī  
board a plane  
登机牌 dēng'jī'pái  
boarding pass

### 灯 dēng

①lamp; lantern; light  
②valve; tube ③burner  
灯光 dēng'guāng  
lamplight; lighting  
灯泡 dēng'pào  
bulb; light bulb  
灯头 dēng'tóu  
lamp holder

### 抵 dǐ

①support; sustain; prop  
②resist; withstand ③compensate  
for; make good ④mortgage ⑤bal-  
ance; set off ⑥be equal to  
抵达 dǐ'dá  
arrive; reach  
抵押 dǐ'yǎ  
mortgage  
抵制 dǐ'zhì  
boycott

### 的 dí

①true; really ②taxi  
的确 dí'què  
indeed; really  
的士 dí'shì  
taxi

### 敌 dí

①enemy; foe ②oppose; fight;  
resist ③match; equal  
敌机 dí'jī  
an enemy plane  
敌人 dí'rén  
enemy; foe  
敌意 dí'yì  
hostility; enmity

### 滴 dī

①drip ②drop  
滴答 dī'dā  
tick; ticktack  
滴管 dī'guǎn  
dropper  
滴剂 dī'jì  
drip

### 低 dī

①low ②let droop  
低估 dī'gū  
underestimate  
低气压 dī'qì'yā  
low pressure  
低声 dī'shēng  
in a low voice

### 弟 dì

younger brother  
弟弟 dì'dì  
younger brother  
弟兄 dì'xiōng  
brother  
弟子 dì'zǐ  
disciple; follower

### 帝 dì

①emperor ②imperialism  
帝国 dì'guó  
empire  
帝王 dì'wáng  
monarch  
帝制 dì'zhì  
monarchy

### 第 dì

①(数词前, 表顺序): 第一 the  
first ②degree; rank 及(落)~ pass(fail  
in) the imperial examinations  
第六感觉 dì'liù'gǎn'jué  
the sixth sense  
第一手 dì'yī'shǒu  
firsthand  
第一线 dì'yī'xiàn  
forefront; front line

### 地 dì

①the earth ②land; soil ③fields  
④ground; floor ⑤place; locality  
⑥position; situation  
地点 dì'diǎn  
site; locale; place  
地理 dì'lǐ  
geography  
地稅 dì'shuì  
local tax

### 底 dǐ

①bottom; base ②the heart of  
matter; ins and outs ③rough draft  
④ground; background; foundation  
底板 dǐ'bǎn  
base plate  
底价 dǐ'jià  
base price  
底下 dǐ'xià  
under; below; next

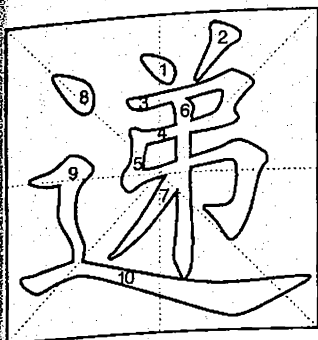

递 dì 316

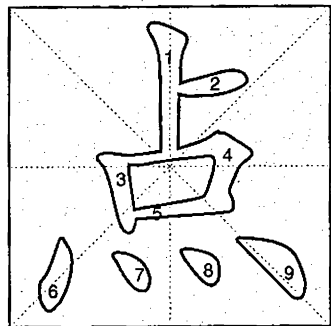

点 diǎn 317

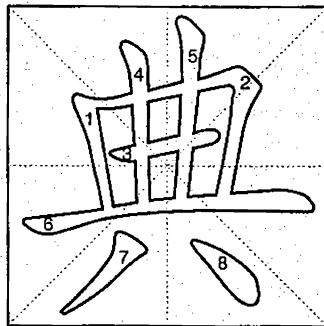

典 diǎn 318

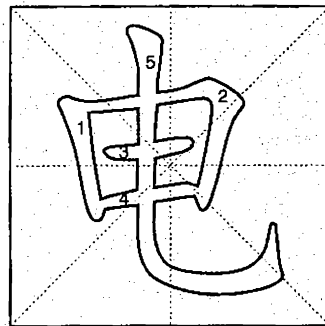

电 diàn 319

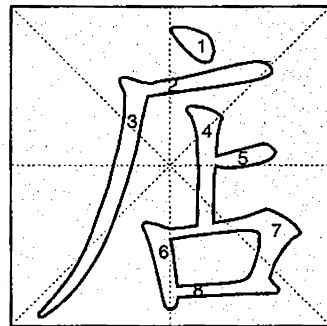

店 diàn 320

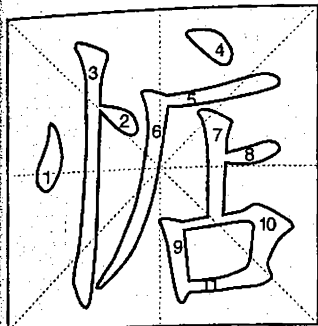

掂 diàn 321

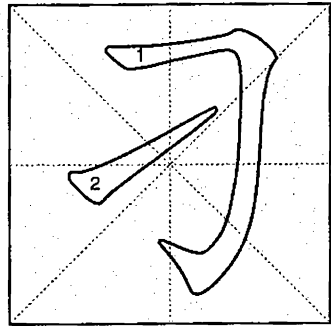

刁 diāo 322

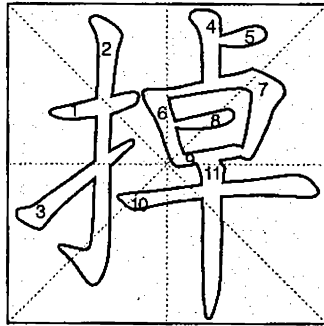

掉 diào 323

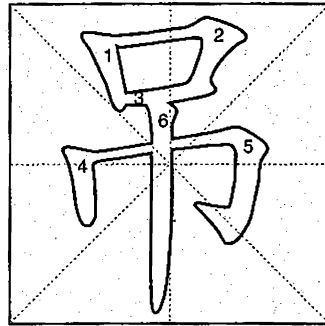

吊 diào 324

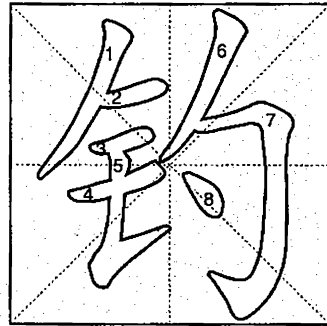

钓 diào 325

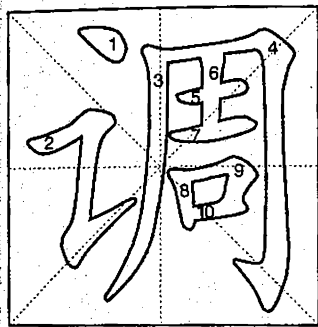

调 diào 326

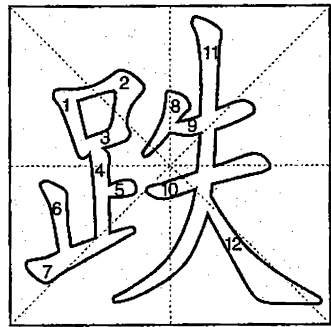

跌 diē 327

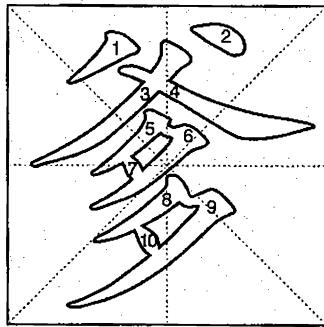

爹 diē 328

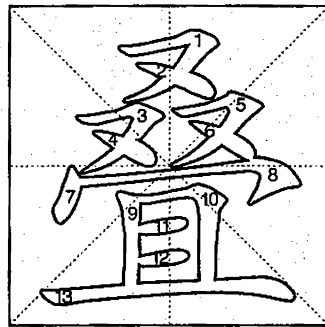

叠 dié 329

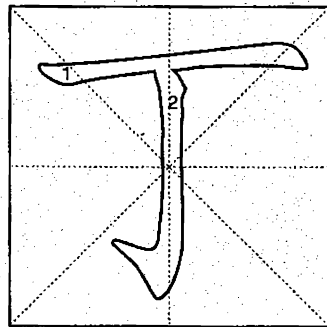

丁 dīng 330



### 店 diàn

store; shop; inn  
 店面 diàn'miàn  
 shop front  
 店员 diàn'yuán  
 shop assistant  
 店主 diàn'zhǔ  
 shopkeeper

### 电 diàn

① electricity ② give or get an electric shock ③ telegram; cable  
 电报 diàn'bào  
 telegram; cable  
 电池 diàn'chí  
 electric cell; battery  
 电话卡 diàn'huà'kǎ  
 phone card; calling card

### 典 diǎn

① standard; law; canon ② standard work of scholarship ③ allusion; literary quotation  
 典当 diǎn'dàng  
 pawn  
 典范 diǎn'fàn  
 model; example  
 典礼 diǎn'lǐ  
 celebration

### 点 diǎn

① drop (of liquid) ② spot ③ point ④ a bit ⑤ aspect; feature ⑥ touch; skim ⑦ drip  
 点菜 diǎn'cài  
 order dishes  
 点击 diǎn'jī  
 hit; click  
 点头 diǎn'tóu  
 nod one's head; nod

### 递 dì

give; pass  
 递给 dì'gěi  
 hand over; pass on  
 递交 dì'jiāo  
 hand over; present  
 递增 dì'zēng  
 increase progressively

### 钓 diào

angle; fish with a hook and line  
 钓钩 diào'gōu  
 fishhook  
 钓具 diào'jù  
 fishing tackle  
 钓鱼 diào'yú  
 angle; go fishing

### 吊 diào

① hang; suspend ② lift up or let down with a rope, etc. ③ condole; mourn  
 吊车 diào'chē  
 crane; hoist  
 吊扇 diào'shàn  
 ceiling fan  
 吊唁 diào'yàn  
 condole

### 掉 diào

① fall; drop; shed; come off ② lose; be missing ③ change; exchange; swap ④ turn  
 掉队 diào'duì  
 drop out; fall behind  
 掉泪 diào'lèi  
 tears falling  
 掉头 diào'tóu  
 turn round; turn about

### 刁 diāo

tricky; artful; sly  
 刁悍 diāo'hàn  
 cunning and fierce  
 刁滑 diāo'huá  
 cunning; crafty; artful  
 刁难 diāo'nàn  
 create difficulties

### 惦 diàn

remember with concern  
 惦记 diàn'jì  
 think about  
 惦念 diàn'niàn  
 keep thinking about

### 丁 dīng

① man ② fourth  
 丁点儿 dīng'diǎnr  
 a tiny bit  
 丁香 dīng'xiāng  
 lilac  
 丁字镐 dīng'zì'gǎo  
 pickax

### 叠 dié

① pile up; repeat ② fold  
 叠罗汉 dié'luó'hàn  
 pyramid

### 爹 diē

father; dad; daddy; pa

### 跌 diē

① fall; tumble ② drop  
 跌倒 diē'dǎo  
 fall; tumble  
 跌价 diē'jià  
 go down in price  
 跌跤 diē'jiāo  
 trip and fall

### 调 diào

① transfer; shift; move ② accept  
 ③ key ④ air; tune; melody ⑤ tone; tune  
 调查 diào'chá  
 investigate; survey  
 调令 diào'lìng  
 transfer order  
 调任 diào'rèn  
 transferred to another post

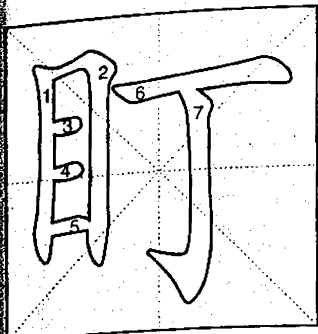

叮 dīng 331

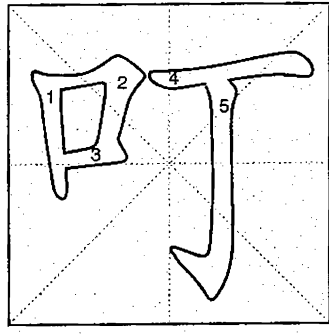

叮 dīng 332

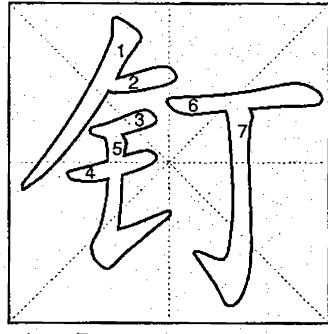

钉 dīng 333

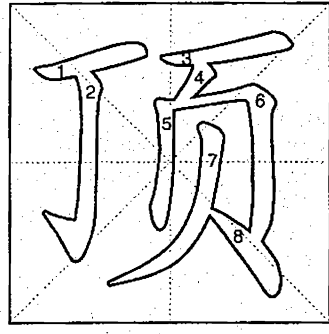

顶 dǐng 334

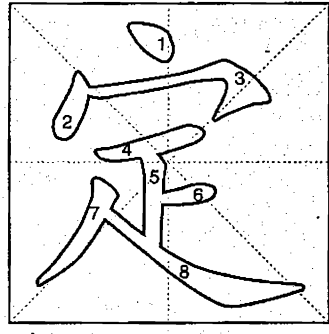

定 dìng 335

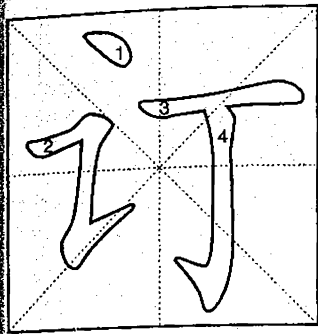

订 dìng 336

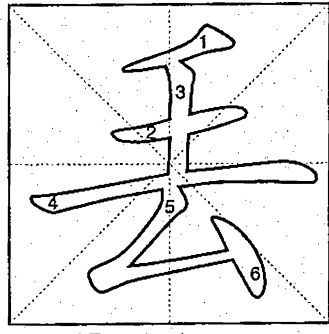

丢 diū 337

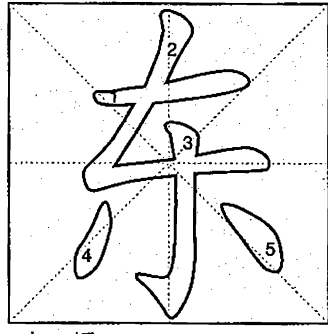

东 dōng 338

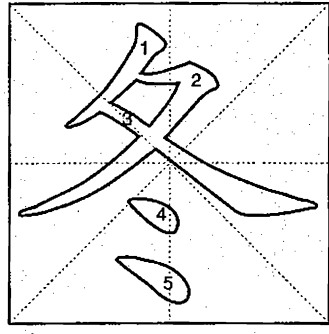

冬 dōng 339

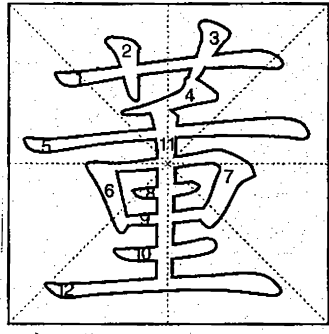

董 dǒng 340

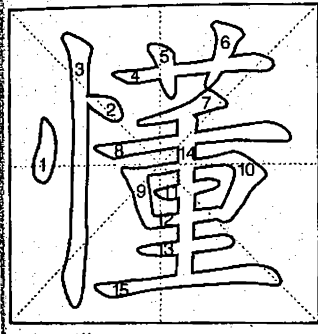

懂 dǒng 341

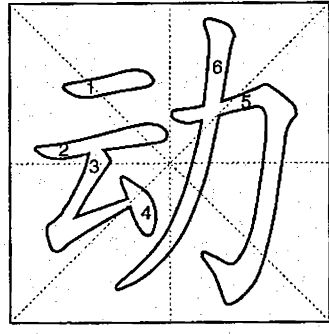

动 dòng 342

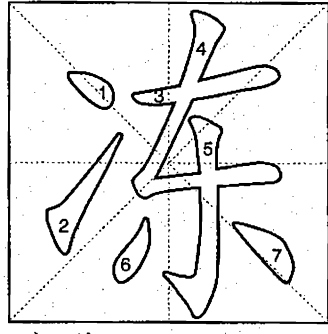

冻 dòng 343

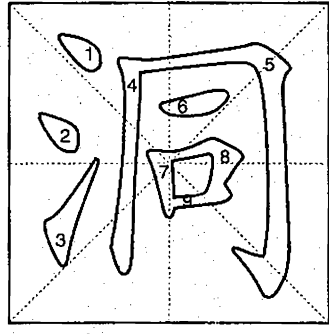

洞 dòng 344

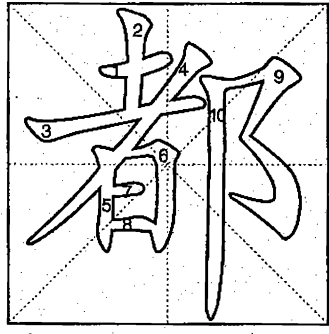

都 dōu 345

**定 dìng**

① calm; stable; quiet ② decide; fix; set ③ fixed; settled; established

订婚 dìng'hūn

be betrothed

定货 dìng'huò

order goods

定金 dìng'jīn

down payment

**顶 dǐng**

① the crown of the head ② top 山~ hilltop 屋~ roof ③ carry on the head ④ retort; turn down ⑤ take the place of ⑥ very; most; extremely

顶灯 dǐng'dēng

dome light

顶级 dǐng'jí

top-notch

顶住 dǐng'zhù

withstand; stand up to

**钉 dīng**

① nail; tack ② follow closely; tail ③ urge; press

钉锤 dīng'chuí

nail hammer

钉梢 dīng'shāo

shadow sb.; tail sb.

钉子 dīng'zi

nail; snag

**叮 dīng**

① sting; bite ② say or ask again to make sure

叮咛 dīng'ning

warn repeatedly

叮咬 dīng'yǎo

sting; bite

叮嘱 dīng'zhǔ

warn; exhort

**盯 dīng**

fix one's eyes on; gaze at; stare

盯防 dīng'fáng

(in ball games) close-mark defence; man-for-man defence

盯梢 dīng'shāo

shadow sb.; tail sb.

盯住 dīng'zhù

keep a close watch(on)

**董 dǒng**

direct; superintend; supervise

董事 dǒng'shì

director; trustee

董事会 dǒng'shì'huì

board of directors

董事长 dǒng'shì'zhǎng

chairman of the board

**冬 dōng**

winter

冬季 dōng'jì

winter

冬眠 dōng'mián

winter sleep

冬泳 dōng'yǒng

winter swimming

**东 dōng**

east; master; owner; host ~ 郊 eastern suburbs 房~landlord 远(中、近)~Far (Middle, Near) East 做~stand host; stand treat

东奔西跑 dōng'bēn'xī'pǎo

rush about

东道主 dōng'dào'zhǔ

host

东家 dōng'jiā

master; boss

**丢 diū**

① lose; mislay ② throw; cast; toss

③ put aside

丢饭碗 diū'fàn'wǎn

lose one's job

丢脸 diū'liǎn

lose one's face

丢失 diū'shī

lose

**订 dìng**

① conclude; draw up; agree

② subscribe to (a newspaper, etc.); book (seats, tickets, etc.) order (merchandise, etc.)

订单 dìng'dān

order form

订户 dìng'hù

subscriber

订货 dìng'huò

order goods

**都 dōu**

① all ② even ③ already

**洞 dòng**

① hole; cavity ② penetratingly; thoroughly

洞察 dòng'chá

see clearly

洞房 dòng'fáng

bridal chamber

洞悉 dòng'xī

know clearly

**冻 dòng**

① freeze ② jelly ③ feel very cold; freeze

冻冰 dòng'bīng

freeze

冻伤 dòng'shāng

frostbite

冻死 dòng'sǐ

freeze to death

**动 dòng**

① move; stir ② act ③ change; alter ④ use ⑤ touch (one's heart); arouse

动工 dòng'gōng

start building

动物园 dòng'wù'yuán

zoo; zoological garden

动摇 dòng'yáo

shake; waver

**懂 dǒng**

understand; know

懂得 dǒng'dé

understand; grasp

懂行 dǒng'háng

know the business

懂礼貌 dǒng'lǐ'mào

have good manners

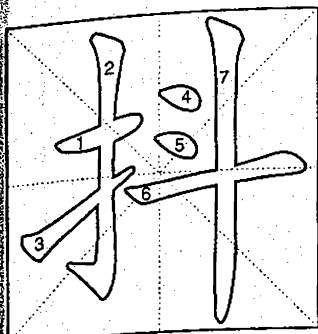

抖 dǒu 346

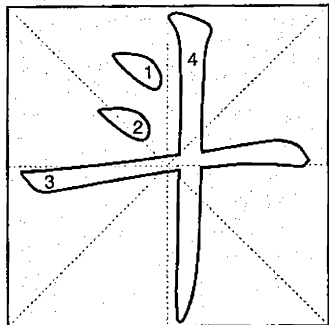

斗 dǒu 347

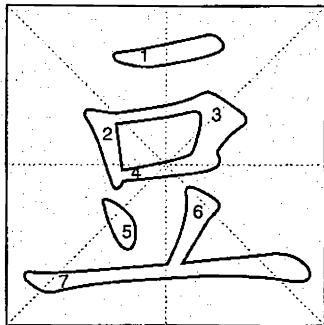

豆 dòu 348

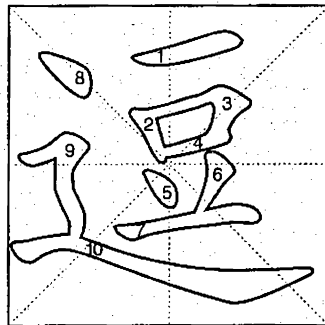

逗 dòu 349

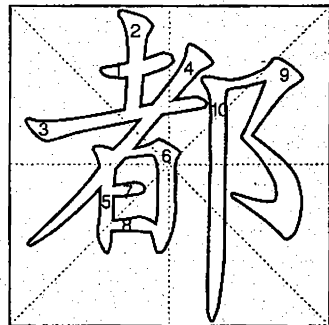

都 dū 350

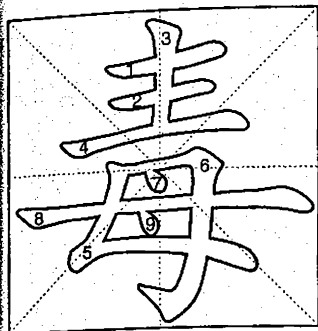

毒 dú 351

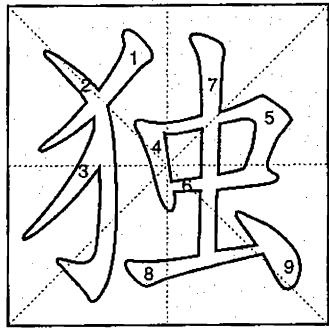

独 dú 352

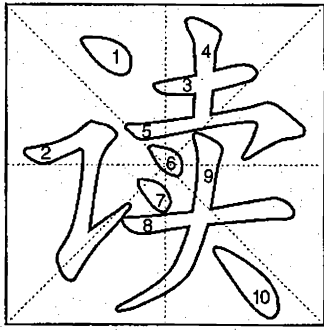

读 dú 353

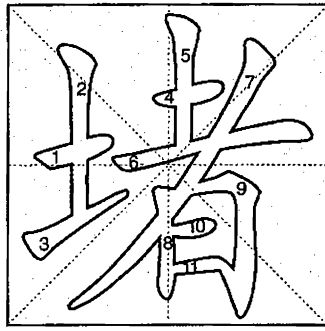

堵 dǔ 354

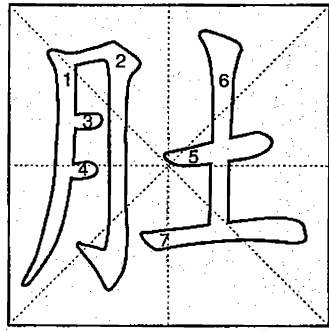

肚 dù 355

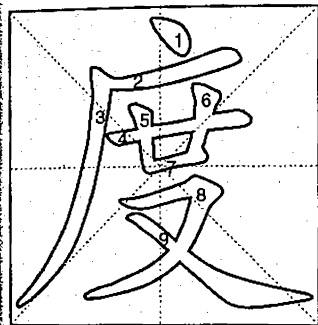

度 dù 356

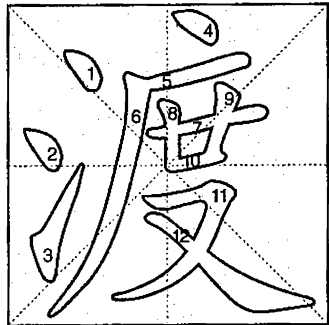

渡 dù 357

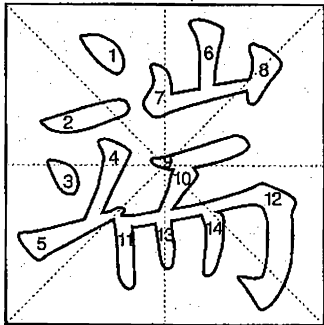

端 duān 358

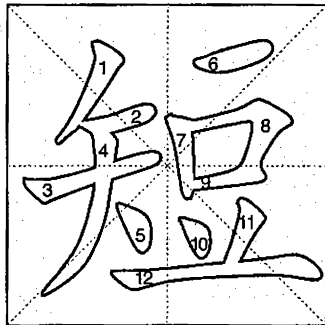

短 duǎn 359

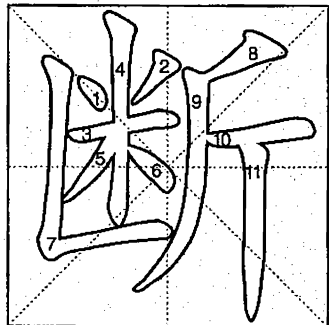

断 duàn 360

### 都 dū

①capital ②big city; metropolis  
 都城 dū'chéng  
 capital  
 都会 dū'hui  
 city; metropolis  
 都市 dū'shì  
 city; metropolis

### 逗 dòu

tease; funny  
 逗号 dòu'hào  
 comma(符号为,)  
 逗留 dòu'liú  
 stay; stop  
 逗弄 dòu'nòng  
 tease; make fun of

### 豆 dòu

peas; beans  
 豆腐 dòu'fu  
 bean curd; tofu  
 豆奶 dòu'nǎi  
 soyamilk  
 豆油 dòu'yóu  
 soyabean oil

### 斗 dǒu

dou, a unit of dry measure for grain (=1 decalitre)  
 斗笠 dòu'lì  
 bamboo hat  
 斗篷 dòu'peng  
 cape; cloak  
 斗室 dòu'shì  
 small room

### 抖 dǒu

①tremble; shiver; quiver②shak  
 jerk ③stir up  
 抖动 dòu'dòng  
 tremble; vibrate  
 抖擞 dòu'sǒu  
 enliven; rouse  
 抖威风 dòu'wēi'fēng  
 throw one's weight about

### 肚 dù

belly; abdomen; stomach  
 肚量 dù'liàng  
 tolerance; magnanimity  
 肚皮 dù'pí  
 belly  
 肚脐 dù'qí  
 navel; belly button

### 堵 dǔ

①stop up; block up ②stifled; suf-  
 focated; oppressed  
 堵车 dǔ'chē  
 jam; traffic jam  
 堵塞 dǔ'sè  
 block up; jam  
 堵嘴 dǔ'zuǐ  
 gag sb.; silence sb.

### 读 dú

read  
 读本 dú'běn  
 reader; textbook  
 读书人 dú'shū'rén  
 a scholar  
 读者 dú'zhě  
 reader

### 独 dú

①only; single ②alone; by one-  
 self; in solitude  
 独立 dú'lì  
 independence  
 独一无二 dú'yī'wú'èr  
 unique; unparalleled  
 独自 dú'zì  
 alone; by oneself

### 毒 dú

①poison; toxin ②narcotics  
 ③noxious ④poison ⑤malicious  
 cruel; fierce  
 毒犯 dú'fàn  
 drug criminal  
 毒品 dú'pǐn  
 narcotic drugs  
 毒气 dú'qì  
 poisonous gas

### 断 duàn

①break; snap ②break off; stop  
 ③give up; abstain from ④judge;  
 decide ⑤absolutely; decidedly  
 断案 duàn'àn  
 settle a lawsuit  
 断档 duàn'dàng  
 be out of stock  
 断交 duàn'jiāo  
 break off a friendship

### 短 duǎn

①short; brief ②lack; owe  
 ③weak point; fault  
 短波 duǎn'bō  
 shortwave  
 短处 duǎn'chù  
 shortcoming; fault  
 短片 duǎn'piān  
 short (film)

### 端 duān

point; end  
 端午节 duān'wù'jié  
 the Dragon Boat Festival  
 端线 duān'xiàn  
 base line  
 端正 duān'zhèng  
 upright; regular

### 渡 dù

①cross (a river, the sea, etc.)  
 ②tide over (a difficulty, etc.); pull  
 through ③ferry (people, goods, etc.)  
 across  
 渡船 dù'chuán  
 ferryboat; ferry  
 渡口 dù'kǒu  
 ferry; ferry crossing  
 渡轮 dù'lún  
 ferry; ferry boat

### 度 dù

①linear measure ②degree of  
 intensity ③degree ④time ⑤spent  
 pass ⑥kilowatt-hour  
 度假 dù'jià  
 spend one's holidays  
 度量 dù'liàng  
 tolerance; magnanimity  
 度蜜月 dù'mì'yuè  
 honeymoon



段 duàn 361



锻 duàn 362

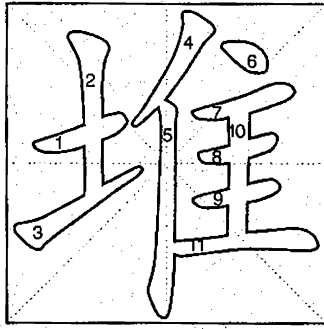

堆 duī 363

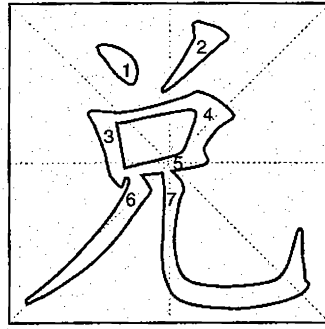

兑 duì 364

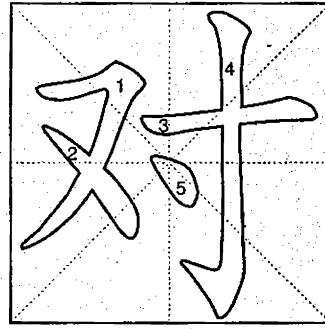

对 duì 365

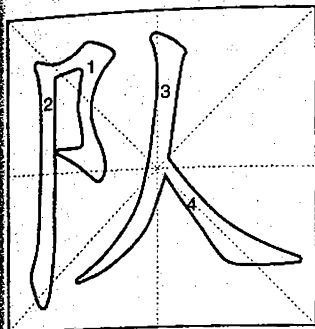

队 duì 366

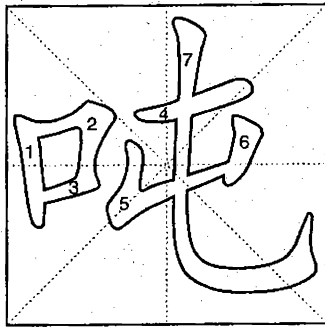

吨 dūn 367

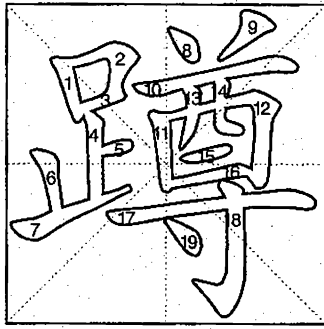

蹲 dūn 368

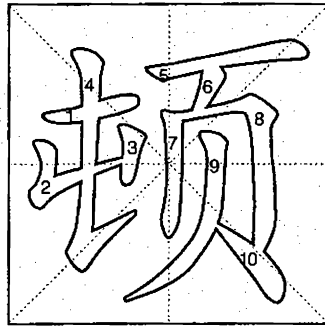

顿 dùn 369

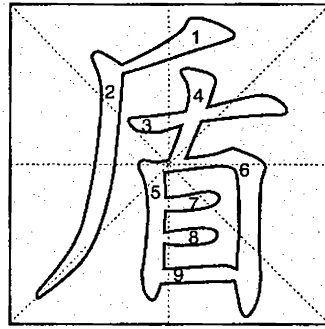

盾 dùn 370

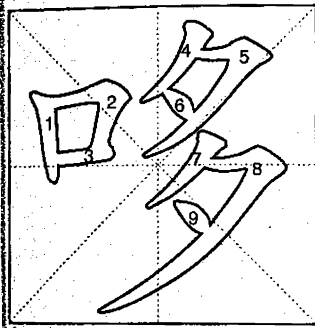

哆 duō 371

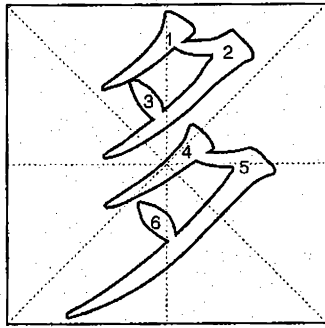

多 duō 372

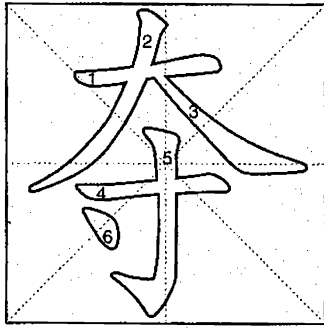

夺 duó 373

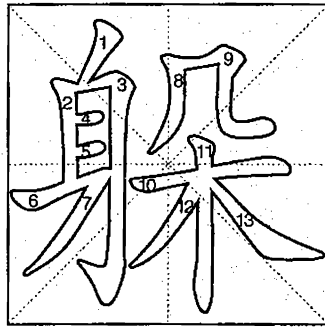

躲 duǒ 374

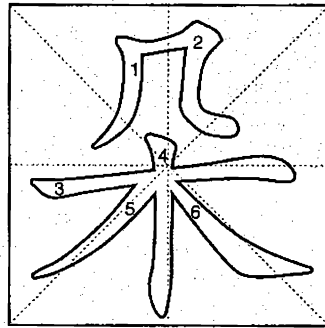

朵 duǒ 375

### 对 duì

① answer; reply ② treat; cope with; counter ③ be trained on; be directed at ④ mutual; face to face  
⑤ opposing  
对白 duì'bái  
dialogue  
对策 duì'cè  
countermeasure  
对外贸易 duì'wài'mào'yì  
foreign trade

### 兑 duì

① exchange ② add (water, etc.)  
兑付 duì'fù  
cash (a check; etc.)  
兑换 duì'huàn  
exchange; convert  
兑现 duì'xiàn  
cash a check

### 堆 duī

① pile up; heap up; stack  
② heap; pile; crowd  
堆放 duī'fàng  
pile up; stack  
堆积 duī'jī  
pile up; heap up  
堆栈 duī'zhàn  
storehouse

### 锻 duàn

forge  
锻工 duàn'gōng  
forging; forger  
锻炼 duàn'liàn  
take exercise  
锻造 duàn'zào  
forging; smithing

### 段 duàn

① section; segment; part  
② passage  
段落 duàn'luò  
paragraph; phase

### 盾 dùn

shield  
盾牌 dùn'pái  
shield; pretext; excuse

### 顿 dùn

① pause ② arrange; settle  
③ stamp (one's foot) ④ suddenly;  
immediately  
顿号 dùn'hào  
slight pause mark  
顿时 dùn'shí  
immediately; at once

### 蹲 dūn

① squat (on the heels) ② stay  
蹲班 dūn'bān  
have to repeat courses  
蹲点 dūn'diǎn  
stay (at a selected spot)  
蹲监狱 dūn'jiān'yù  
lie in prison

### 吨 dūn

ton  
吨位 dūn'wèi  
tonnage

### 队 duì

① a row of people; line  
② team; group  
队伍 duì'wǔ  
troops; ranks; contingent  
队形 duì'xíng  
formation  
队员 duì'yuán  
team member

### 朵 duǒ

(量)一朵花 (liàng)yī'duǒ'huā  
a flower  
一朵云 yī'duǒ'yún  
a cloud

### 躲 duǒ

① hide (oneself)  
② avoid; dodge  
躲避 duǒ'bì  
avoid; dodge; elude  
躲闪 duǒ'shǎn  
dodge; evade  
躲雨 duǒ'yǔ  
take shelter from the rain

### 夺 duó

① take by force; seize ② force  
one's way ③ contend for; compete  
for ④ deprive  
夺杯 duó'bēi  
win the cup  
夺回 duó'huí  
recapture; take back  
夺权 duó'quán  
take seize power

### 多 duō

① many; much; more ② too  
many ③ excessive; too much  
④ more; over; odd ⑤ much more;  
far more  
多病 duō'bìng  
constantly ill  
多次 duō'cì  
many times  
多多少少 duō'duō'shǎo'shǎo  
more or less

### 哆嗦 duō'suo

哆嗦 duō'suo  
tremble; shiver



醵 é 376



餓 è 377



額 é 378

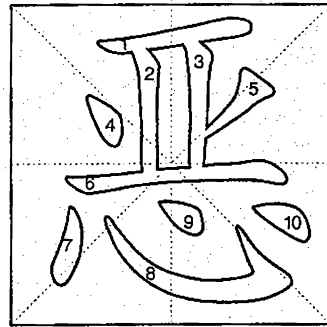

惡 è 379

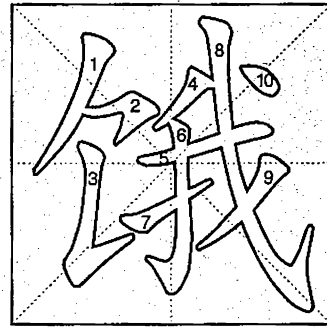

餓 è 380

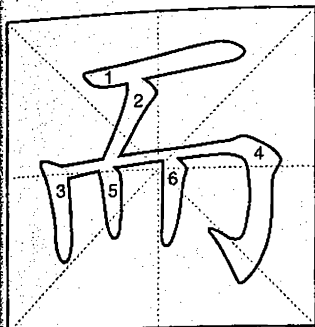

而 ér 381

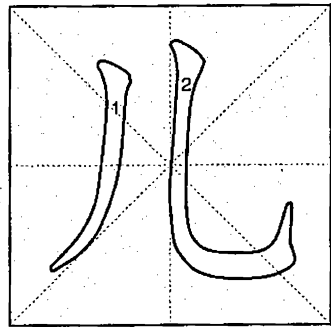

儿 ér 382

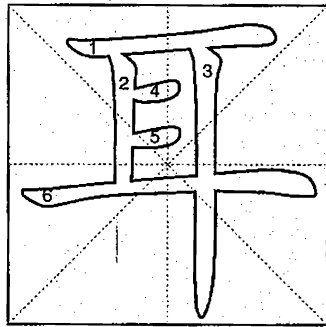

耳 ěr 383

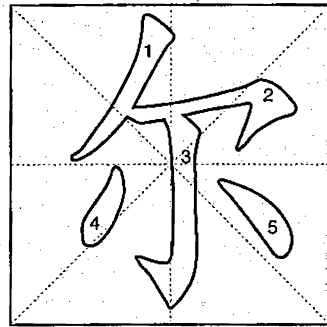

尔 ěr 384

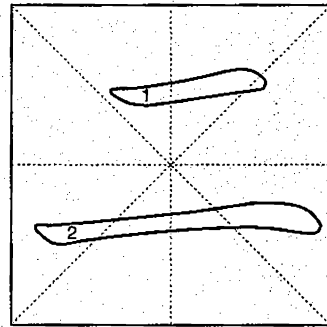

二 èr 385

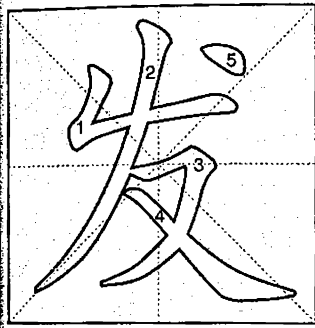

发 fā 386

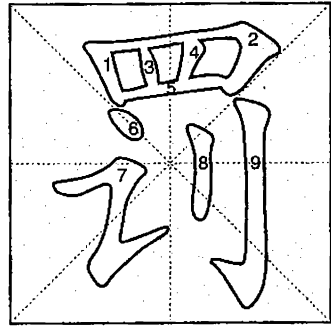

罚 fá 387

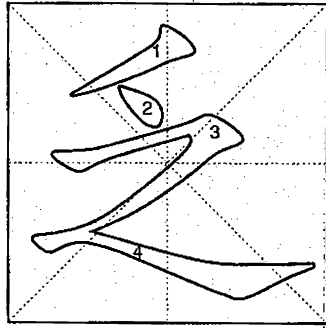

乏 fá 388

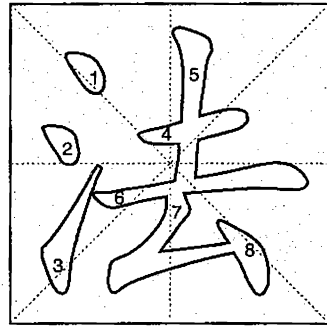

法 fǎ 389

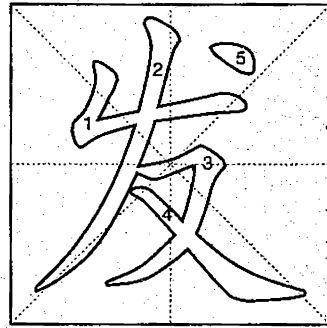

发 fà 390



饿 è

①hungry ②starve  
饿殍 è'piǎo  
bodies of the starved

恶 è

①evil; vice; wickedness  
②fierce; ferocious ③bad; wicked  
恶梦 è'mèng  
nightmare  
恶习 è'xí  
bad habit  
恶作剧 è'zuò'jù  
prank; mischief

额 é

①forehead ②a horizontal tablet  
③a specified number or amount  
额度 é'dù  
quota; prescribed amount or pro-  
portion  
额头 é'tóu  
forehead  
额外 é'wài  
extra; additional

俄 é

very soon; presently; suddenly  
俄罗斯 é'lúó'sī  
Russia  
俄语 é'yǔ  
Russian (language)

鹅 é

goose  
鹅黄 é'huáng  
light yellow  
鹅卵石 é'lúǎn'shí  
cobble  
鹅毛大雪 é'máo'dà'xuě  
large snow flakes

二 èr

①two ②different  
二百五 èr'bǎi'wǔ  
a stupid person  
二分之一 èr'fēn'zhī'yī  
a half  
二月 èr'yuè  
February

尔 ěr

①you ②like that; so

耳 ěr

①ear ②side  
耳朵 ěr'duo  
ear  
耳环 ěr'huán  
earrings  
耳语 ěr'yǔ  
whisper (in sb.'s ear)

儿 ér

①child ②youngster; youth  
③son ④male  
儿童 ér'tóng  
child; children  
儿媳妇儿 ér'xí'fù'r  
daughter-in-law  
儿子 ér'zi  
son

而 ér

①and ②but ③from  
而后 ér'hòu  
after that; then  
而今 ér'jīn  
now  
而且 ér'qiě  
besides; furthermore

发 fā

hair  
发胶 fā'jiāo  
hairspray  
发乳 fā'rǔ  
hair cream  
发型 fā'xíng  
hair style; hairdo

法 fǎ

①law ②method; way; mode  
③follow; model after ④stan-  
dard; model  
法办 fǎ'bàn  
punish by law  
法官 fǎ'guān  
judge; justice  
法人 fǎ'rén  
legal person

乏 fá

①lack ②tired; weary ③ex-  
hausted; worn-out  
乏味 fá'wèi  
dull; insipid; tasteless

罚 fá

punish; penalize  
罚单 fá'dān  
ticket; notice for payment of fine  
罚点球(足球)  
fá'diǎn'qiú(zú'qiú)  
spot kick  
罚金 fá'jīn  
fine; forfeit

发 fā

①send out; issue; deliver; dis-  
tribute ②utter; express ③dis-  
charge; shoot; emit ④develop; ex-  
pand  
发表 fā'biǎo  
issue; publish; air  
发达国家 fā'dá'guó'jiā  
developed country  
发火 fā'huǒ  
catch fire; get angry

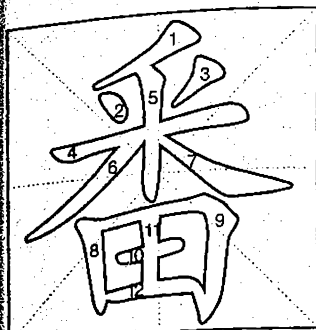

番 fān 391

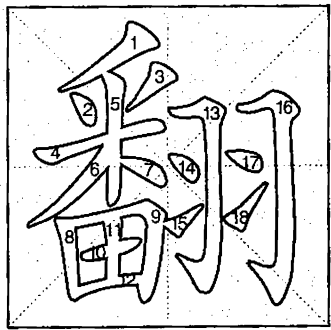

翻 fān 392

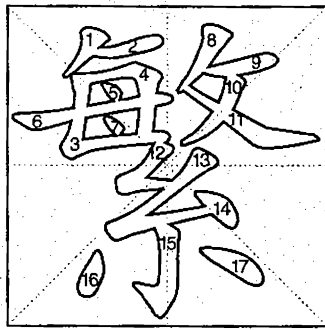

繁 fán 393

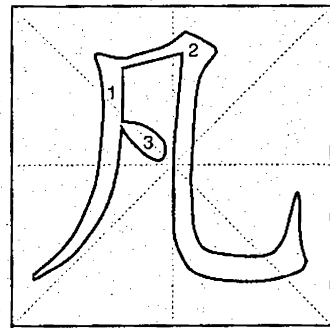

凡 fán 394

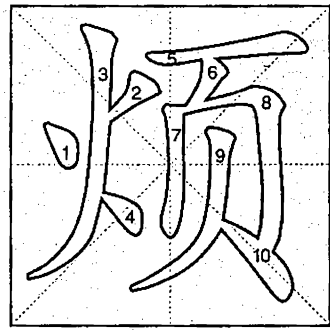

烦 fán 395

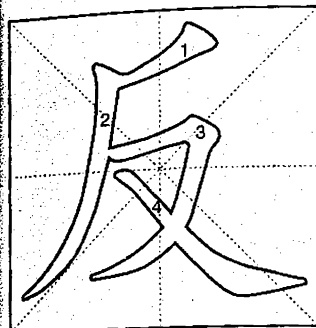

反 fǎn 396

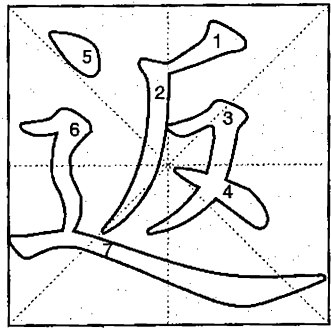

返 fǎn 397

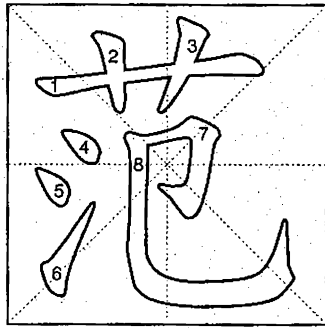

范 fàn 398

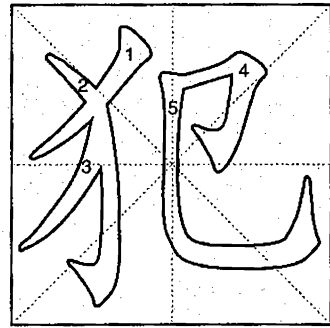

犯 fàn 399

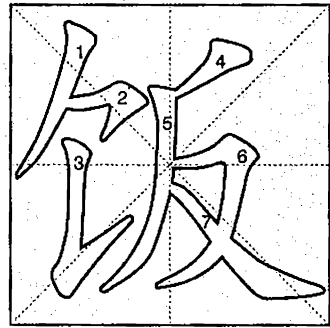

饭 fàn 400

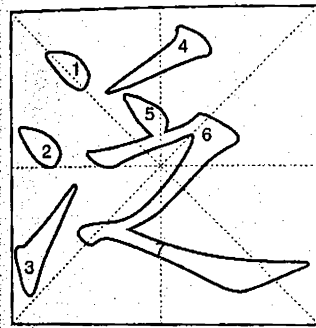

泛 fàn 401

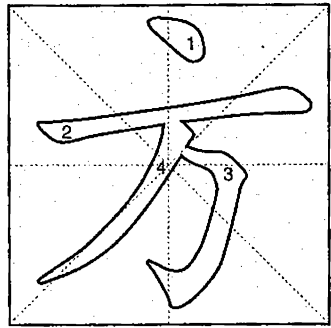

方 fāng 402

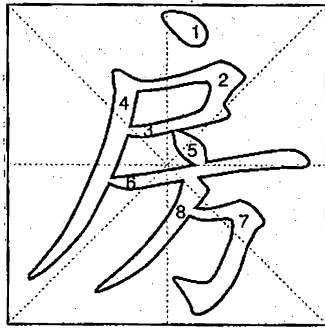

房 fáng 403

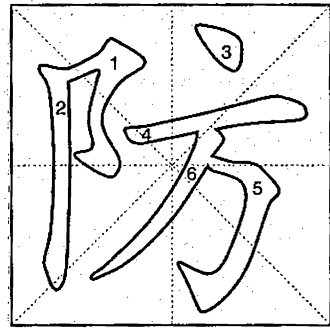

防 fáng 404

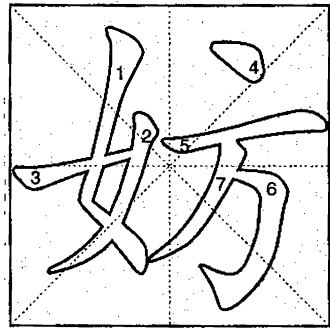

妨 fáng 405

### 烦 fán

① be vexed; be irritated; be annoyed ② be tired of ③ superfluous and confusing ④ trouble  
 烦闷 fán'mèn  
 be worried; be unhappy  
 烦扰 fán'rǎo  
 bother; disturb  
 烦人 fán'rén  
 annoying; vexing

### 凡 fán

① commonplace; ordinary  
 ② this mortal world  
 ③ every; any; all  
 凡人 fán'rén  
 ordinary person; mortal  
 凡事 fán'shì  
 everything  
 凡是 fán'shì  
 every; any; all

### 繁 fán

① numerous; manifold  
 ② propagate; multiply  
 繁多 fán'duō  
 various  
 繁华 fán'huá  
 flourishing; bustling  
 繁重 fán'zhòng  
 heavy

### 翻 fān

① turn over ② cross; get over ③ rummage; search ④ translate ⑤ reverse ⑥ multiply ⑦ fall out; break up  
 翻案 fān'àn  
 reverse a verdict  
 翻译 fān'yì  
 translate; interpret  
 翻印 fān'yìn  
 reprint; reproduce

### 番 fān

time  
 番号 fān'hào  
 designation  
 番茄 fān'qié  
 tomato  
 番薯 fān'shǔ  
 sweet potato

### 饭 fàn

① cooked rice or other cereals  
 ② meal  
 饭店 fàn'diàn  
 hotel; restaurant  
 饭量 fàn'liàng  
 appetite  
 饭厅 fàn'tīng  
 dining hall(room)

### 犯 fàn

① violate; offend (against law, etc.) ② attack; assail; work against ③ criminal ④ commit (a mistake, crime, etc.)  
 犯愁 fàn'chóu  
 worry; be anxious  
 犯法 fàn'fǎ  
 violate the law  
 犯人 fàn'rén  
 prisoner; convict

### 范 fàn

① example; pattern ② limits  
 范本 fàn'běn  
 model painting  
 范例 fàn'lì  
 example; model  
 范文 fàn'wén  
 model essay

### 返 fǎn

return  
 返潮 fǎn'cháo  
 get damp  
 返航 fǎn'háng  
 return to base or port  
 返校 fǎn'xiào  
 return to school

### 反 fǎn

① turn over ② in an opposite direction; in reverse; inside out ③ the contrary; instead ④ return  
 反驳 fǎn'bó  
 refute; retort; rebut  
 反常 fǎn'cháng  
 unusual; abnormal; strange  
 反感 fǎn'gǎn  
 be disgusted with

### 妨 fāng

hinder; impede; obstruct  
 妨碍 fāng'ài  
 hinder; hamper; impede  
 妨害 fāng'hài  
 impair; jeopardize

### 防 fáng

① guard against; provide  
 ② defend  
 防尘 fáng'chén  
 dustproof  
 防护 fáng'hù  
 protect; shelter  
 防火 fáng'huǒ  
 fire prevention

### 房 fáng

① house ② room  
 房产 fáng'chǎn  
 house property  
 房顶 fáng'dǐng  
 roof  
 房间 fáng'jiān  
 room

### 方 fāng

① square ② cubic metre (of lumber, earth, stone, etc.) ③ direction ④ side; party ⑤ place; region; locality  
 方案 fāng'àn  
 scheme; plan; program  
 方法 fāng'fǎ  
 method; way; means  
 方向 fāng'xiàng  
 direction; orientation

### 泛 fàn

① float ② be suffused with (blushes) ③ flood; inundate ④ extensive; general  
 泛泛而谈 fàn'fàn'ér'tán  
 talk in generalities  
 泛滥 fàn'làn  
 be in flood; overflow  
 泛指 fàn'zhǐ  
 make a general reference

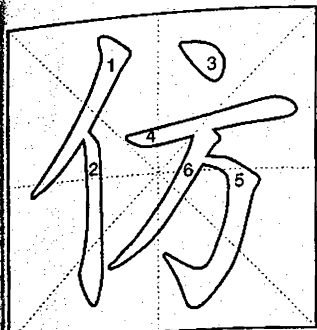

仿 fǎng 406

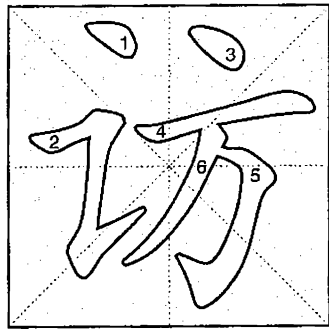

访 fǎng 407

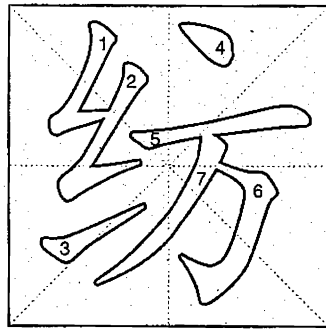

纺 fǎng 408

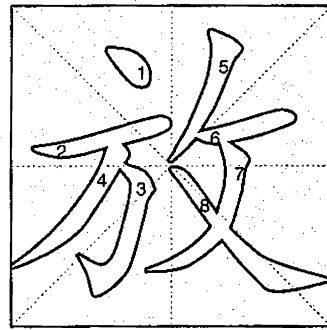

放 fàng 409

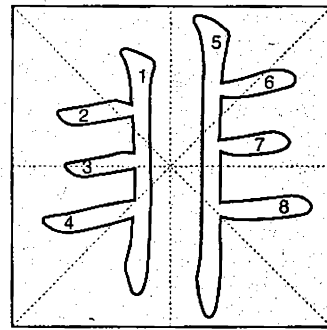

非 fēi 410

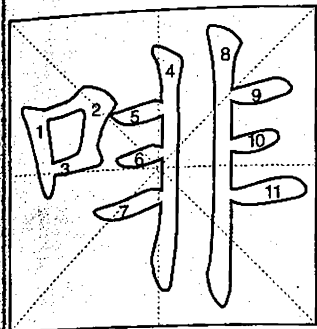

啡 fēi 411

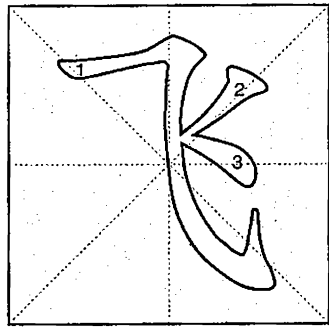

飞 fēi 412

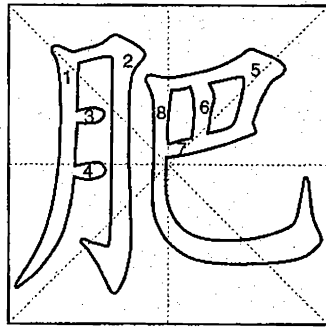

肥 féi 413

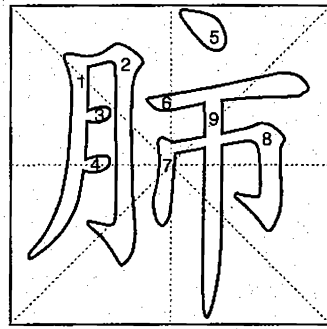

肺 fèi 414

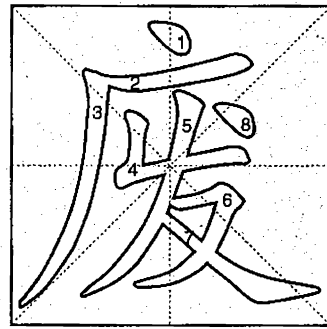

废 fèi 415

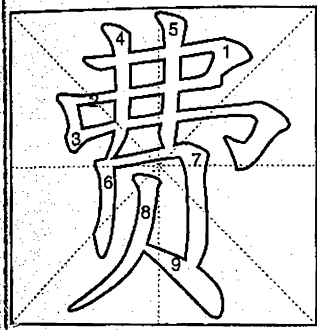

费 fèi 416

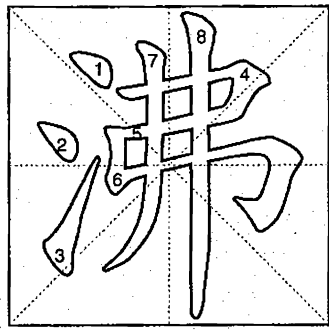

沸 fèi 417

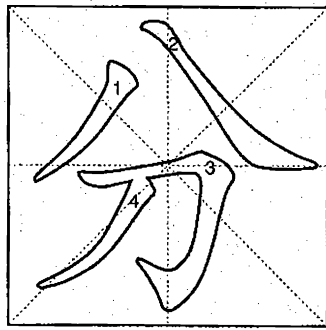

分 fēn 418

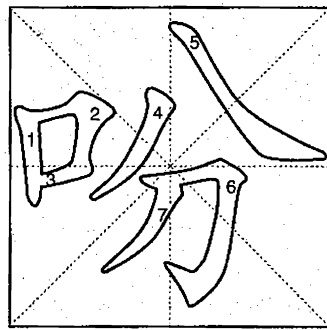

吩 fēn 419

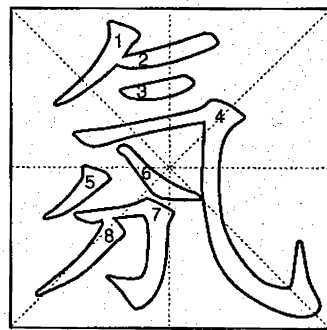

氛 fēn 420

### 非 fēi

① wrong; evildoing ② not conform to; run counter to ③ not; no  
 非常 fēi'cháng  
 unusual; special  
 非但 fēi'dàn  
 not only  
 非卖品 fēi'mài'pǐn  
 (articles) not for sale

### 放 fàng

① let go; set free; release ② let off; give out ③ put out to pasture ④ let oneself go; give way to ⑤ lend (money) at interest  
 放大 fàng'dà  
 enlarge; amplify  
 放弃 fàng'qì  
 abandon; give up  
 放映 fàng'yìng  
 show; project

### 纺 fǎng

① spin ② a thin silk cloth  
 纺纱 fǎng'shā  
 spinning  
 纺织厂 fǎng'zhī'chǎng  
 textile mill  
 纺织品 fǎng'zhī'pǐn  
 textile

### 访 fǎng

① visit ② seek by inquiry or search; try to get  
 访谈 fǎng'tán  
 visit and talk with  
 访问 fǎng'wèn  
 visit; call on  
 访问学者 fǎng'wèn'xué'zhě  
 visiting scholar

### 仿 fǎng

① imitate; copy ② resemble  
 like  
 仿佛 fǎng'fú  
 seem; as if  
 仿生学 fǎng'shēng'xué  
 bionics  
 仿效 fǎng'xiào  
 follow the example of

### 废 fèi

① give up; abandon  
 ② waste; useless; disused  
 废料 fèi'lìào  
 waste (material); scrap  
 废品 fèi'pǐn  
 waste product; reject  
 废水 fèi'shuǐ  
 waste water

### 肺 fèi

lungs  
 肺癌 fèi'ái  
 lung cancer  
 肺腑之言 fèi'fú'zhī'yán  
 words from the bottom of one's heart  
 肺炎 fèi'yán  
 pneumonia

### 肥 féi

① fat ② fertile; rich ③ fertilize  
 ④ fertilizer ⑤ loose-fitting; loose;  
 large  
 肥差 fèi'chāi  
 lucrative task  
 肥胖 fèi'pàng  
 corpulent  
 肥皂 fèi'zào  
 soap

### 飞 fēi

① fly; flit ② swiftly  
 飞机 fēi'jī  
 aircraft; airplane; plane  
 飞快 fēi'kuài  
 very fast  
 飞吻 fēi'wǔn  
 throw a kiss; blow a kiss

### 啡 fēi

咖啡 cā'fēi  
 coffee  
 吗啡 mǎ'fēi  
 morphine

### 氛 fēn

atmosphere  
 氛围 fēn'wéi  
 atmosphere

### 吩 fēn

吩咐 fēn'fù  
 tell; instruct

### 分 fēn

① divide; separate; part; stage by stage ② assign; allot ③ distinguish; differentiate ④ branch (of an organization) ⑤ fraction  
 分布 fēn'bù  
 be distributed  
 分担 fēn'dān  
 share  
 分手 fēn'shǒu  
 say good-bye

### 沸 fèi

boil  
 沸点(物) fèi'diǎn(wù)  
 boiling point  
 沸水 fèi'shuǐ  
 boiling water  
 沸腾 fèi'téng  
 boiling; boil over

### 费 fèi

① fee; dues; expenses; charge  
 ② spend; expend ③ wasteful  
 费解 fèi'jiě  
 hard to understand  
 费力 fèi'lì  
 use great effort  
 费心 fèi'xīn  
 give a lot of care

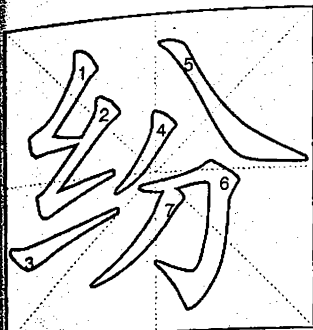

纷 fēn 421

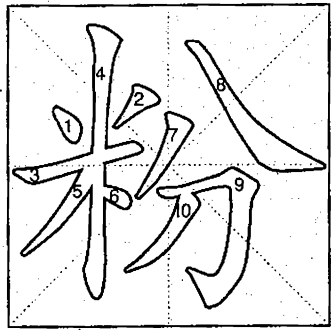

粉 fěn 422

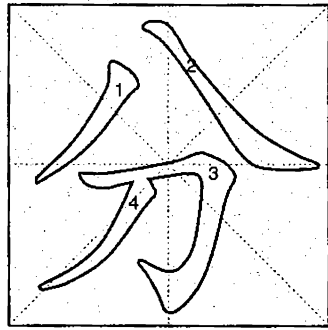

分 fèn 423

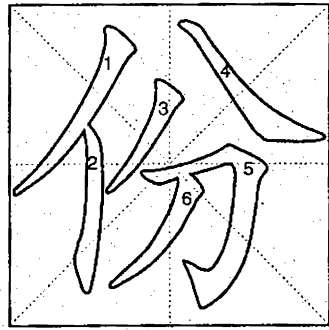

份 fèn 424

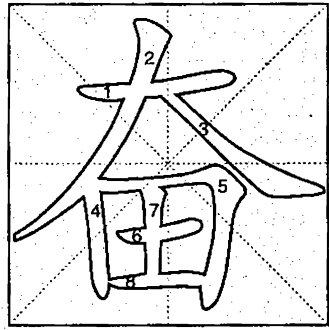

奋 fèn 425

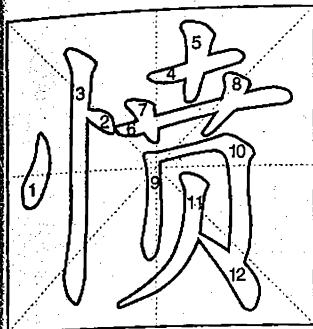

愤 fèn 426

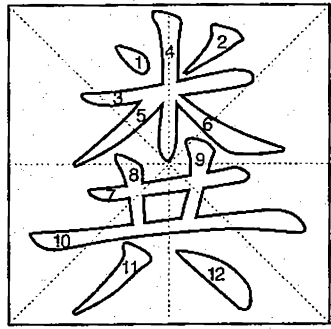

粪 fèn 427

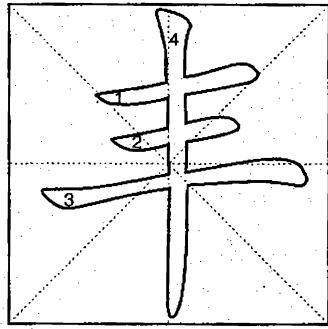

丰 fēng 428

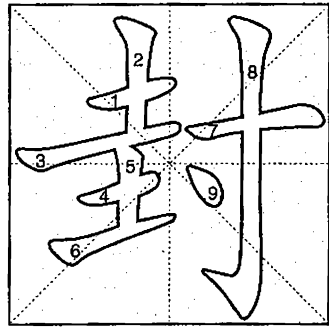

封 fēng 429

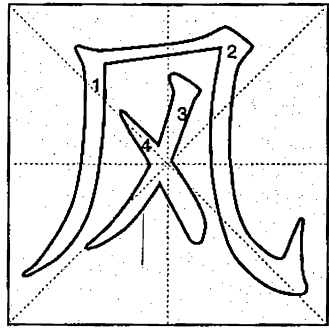

风 fēng 430

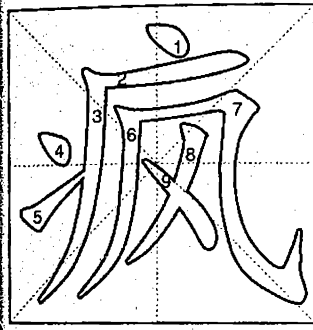

疯 fēng 431

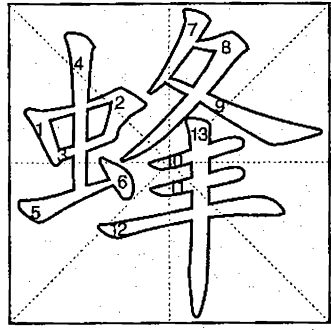

蜂 fēng 432

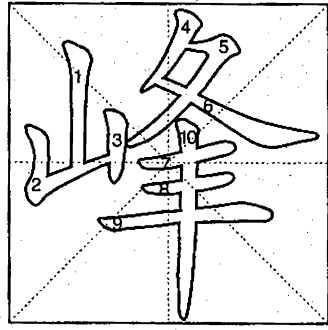

峰 fēng 433

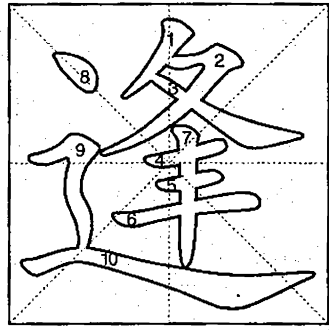

逢 féng 434

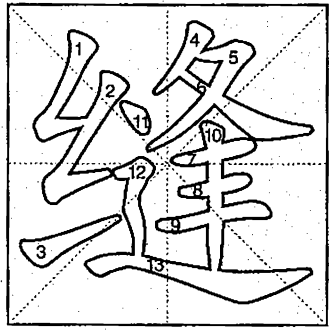

缝 féng 435

**奋 fèn**

- ① exert oneself; act vigorously  
 ② raise; lift  
 奋斗 fèn'dòu  
 struggle; fight; strive  
 奋力 fèn'lì  
 do all one can  
 奋战 fèn'zhàn  
 fight bravely

**份 fèn**

- share; portion  
 份额 fèn'é  
 share; portion

**分 fèn**

- ① component ② what is within  
 one's rights or duty  
 分量 fèn'liàng  
 weight  
 分内 fèn'nèi  
 one's job; one's duty  
 分子 fèn'zǐ  
 member; element

**粉 fěn**

- ① powder ② pink  
 粉笔 fěn'bǐ  
 chalk  
 粉红 fěn'hóng  
 pink  
 粉扑 fěn'pū  
 powder puff

**纷 fēn**

- ① confused; tangled; disorderly  
 ② many and various; profuse  
 纷扰 fēn'rǎo  
 confusion; turmoil  
 纷纭 fēn'yún  
 diverse and confused  
 纷争 fēn'zhēng  
 dispute; wrangle

**风 fēng**

- ① wind ② put out to dry or air  
 ③ winnow ④ style; practice; custom  
 ⑤ scene; view ⑥ news; information  
 风格 fēng'gé  
 style  
 风景 fēng'jǐng  
 scenery; landscape  
 风凉 fēng'liáng  
 cool

**封 fēng**

- ① seal ② bank (a fire) ③ confer  
 (a title, territory, etc.) upon  
 封闭 fēng'bì  
 seal; seal off; close  
 封顶 fēng'dǐng  
 complete a building  
 封口 fēng'kǒu  
 seal; heal

**丰 fēng**

- ① abundant; plentiful ② great  
 ③ fine-looking; handsome  
 丰产 fēng'chǎn  
 bumper crop  
 丰富 fēng'fù  
 rich; abundant  
 丰厚 fēng'hòu  
 rich and generous

**粪 fèn**

- excrement; faeces; dung; drop-  
 pings  
 粪便 fèn'biàn  
 night soil  
 粪肥 fèn'féi  
 muck; dung  
 粪土 fèn'tǔ  
 dung and dirt

**愤 fèn**

- indignation; anger; resentment  
 愤恨 fèn'hèn  
 resent; detest  
 愤慨 fèn'kǎi  
 (righteous) indignation  
 愤怒 fèn'nù  
 indignation; anger

**缝 féng**

- stitch; sew  
 缝补 féng'bǔ  
 sew and mend  
 缝合(医) féng'hé(yī)  
 suture; sew up  
 缝纫机 féng'rèn'jī  
 sewing machine

**逢 féng**

- meet; come upon  
 逢场作戏 féng'chǎng'zuò'xì  
 join in the fun on occasion  
 逢年过节 féng'nián'guò'jié  
 on New Year's Day or other fes-  
 tivals  
 逢凶化吉 féng'xiōng'huà'jí  
 turn ill luck into good

**峰 fēng**

- ① peak; summit ② hump  
 峰会 fēng'huí  
 summit (meeting)  
 峰峦 fēng'luán  
 ridges and peaks  
 峰值 fēng'zhí  
 peak value

**蜂 fēng**

- ① wasp ② bee; honeybee  
 ③ in swarms  
 蜂蜜 fēng'mì  
 honey  
 蜂鸣器 fēng'míng'qì  
 buzzer  
 蜂王精 fēng'wáng'jīng  
 royal jelly

**疯 fēng**

- mad; insane; crazy  
 疯狗 fēng'gǒu  
 mad dog  
 疯牛病 fēng'niú'bìng  
 BSE (bovine spongiform en-  
 cephalopathy); mad cow disease  
 疯子 fēng'zi  
 madman

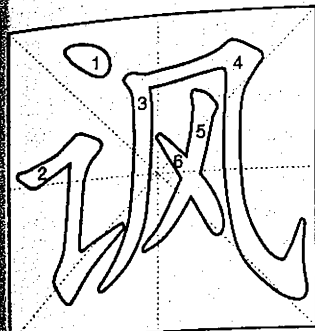

讽 fěng

436

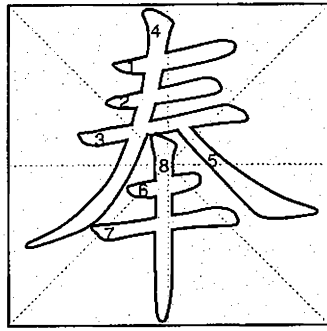

奉 fèng

437

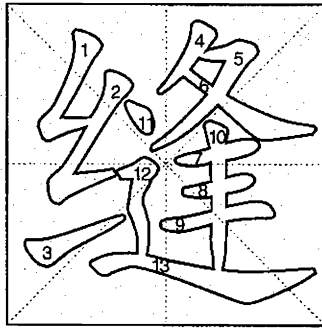

缝 fèng

438

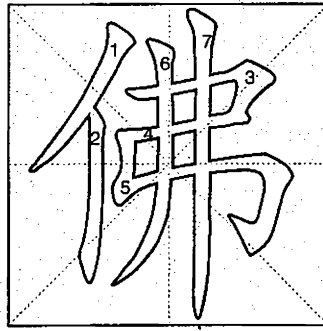

佛 fó

439

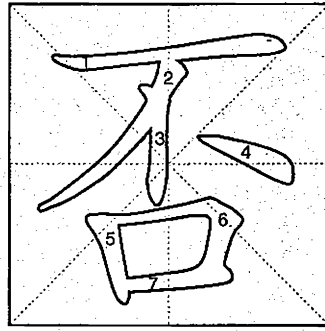

否 ǒu

440

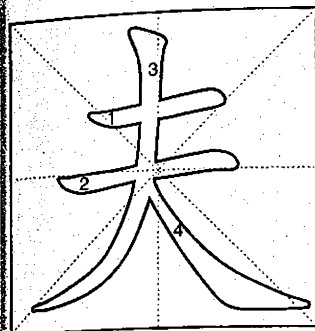

夫 fū

441

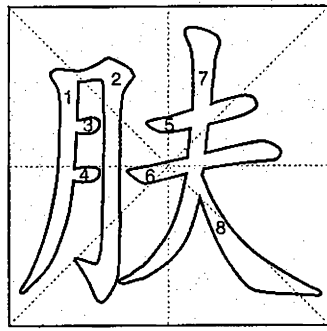

肤 fū

442

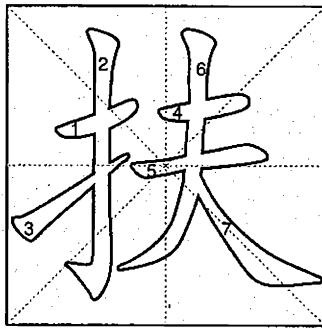

扶 fú

443

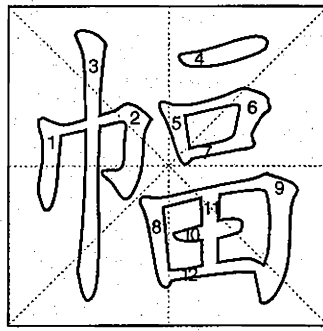

幅 fú

444

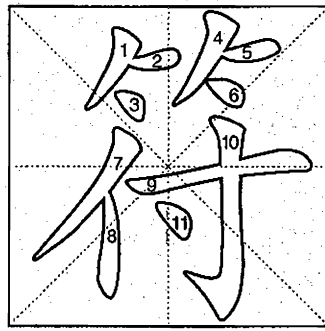

符 fú

445

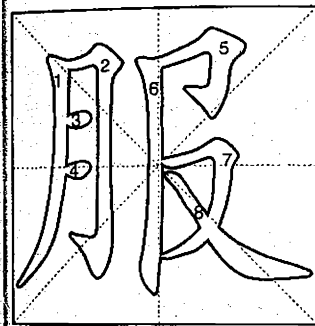

服 fú

446

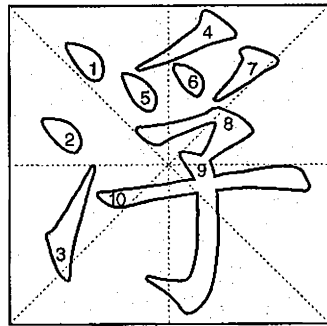

浮 fú

447

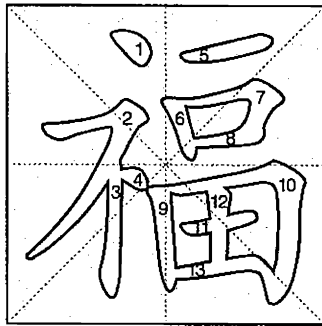

福 fú

448

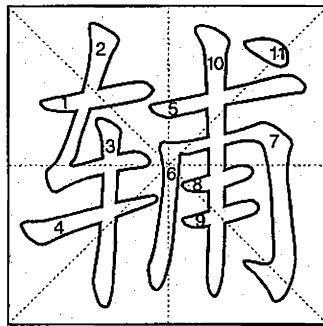

辅 fǔ

449

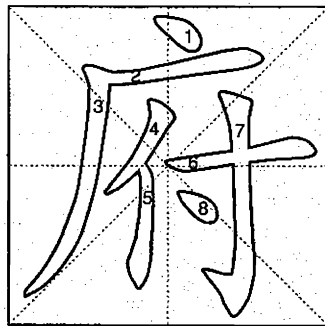

府 fǔ

450



### 否 fǒu

①negate; deny ②no  
否定 fǒu'dìng  
negate; deny  
否决 fǒu'jué  
veto; vote down  
否认 fǒu'rèn  
deny; repudiate

### 佛 fó

①Buddha ②Buddhism  
③image of Buddha  
佛教 fó'jiào  
Buddhism  
佛经 fó'jīng  
Buddhist Scripture  
佛塔 fó'tǎ  
pagoda

### 缝 fèng

①seam ②crack; crevice; fis-  
sure; chink  
缝隙 fèng'xi  
chink; crack; crevice

### 奉 fèng

①give or present with respect  
②receive (orders, etc.) ③esteem;  
revere ④believe in ⑤wait upon;  
attend to  
奉命 fèng'mìng  
act under orders  
奉劝 fèng'quàn  
give advice to  
奉送 fèng'sòng  
offer as a gift

### 讽 fěng

satirize; mock  
讽刺 fěng'cì  
satirize; mock

### 符 fú

①symbol ②tally with; accord  
with  
符号 fú'hào  
symbol; mark; sign  
符合 fú'hé  
accord with; tally with  
符咒 fú'zhù  
incantation

### 幅 fú

①width of cloth ②size  
幅度 fú'dù  
range; scope; extent  
幅员 fú'yuán  
the size of a country

### 扶 fú

①support with the hand  
②help sb. up; straighten sth. up  
③help; relieve  
扶持 fú'chí  
help sustain; give aid to  
扶手 fú'shǒu  
handrail; rail  
扶梯 fú'tī  
staircase

### 肤 fū

skin  
肤浅 fū'qiǎn  
superficial; shallow  
肤色 fū'sè  
colour of skin

### 夫 fū

①husband ②man  
夫妇 fū'fù  
husband and wife  
夫妻 fū'qī  
man and wife  
夫妻店 fū'qī'diàn  
mom-and-pop store

### 府 fǔ

①seat of government; government  
office ②official residence; mansion  
府纲 fǔ'gāng  
poplin  
府第 fǔ'dì  
mansion (house)  
府上 fǔ'shàng  
your home; your family

### 辅 fǔ

assist; complement; supplement  
辅导 fǔ'dǎo  
give guidance to; coach  
辅路 fǔ'lù  
auxiliary lane  
辅助 fǔ'zhù  
assist; supplementary

### 福 fú

good fortune; blessing; happiness  
福利 fú'lì  
welfare; well-being  
福利院 fú'lì'yuàn  
welfare house  
福气 fú'qì  
happy lot; good fortune

### 浮 fú

①float ②swim ③on the sur-  
face; superficial ④temporary;  
provisional ⑤flighty; unstable;  
superficial ⑥hollow; inflated  
浮标 fú'biāo  
buoy  
浮冰 fú'bīng  
floating ice  
浮尘 fú'chén  
surface dust

### 服 fú

①clothes; dress ②take  
(medicine) ③serve (in the army)  
④be convinced; obey ⑤be accus-  
tomed to (the climate)  
服从 fú'cóng  
obey; submit (oneself) to  
服务台 fú'wù'tái  
service desk  
服务员 fú'wù'yuán  
attendant; waiter

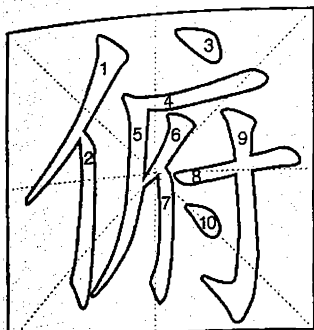

俯 fǔ 451

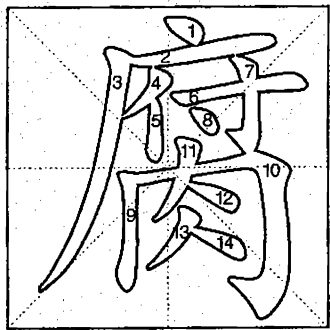

腐 fǔ 452

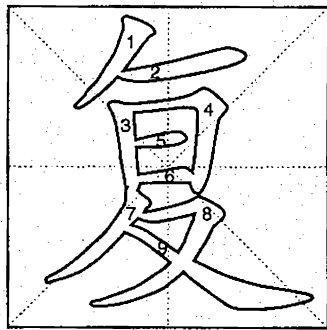

复 fù 453

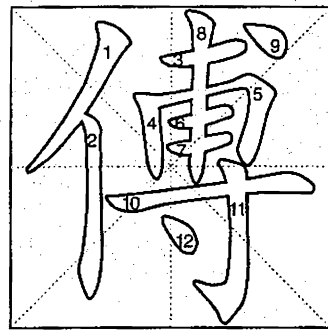

傅 fù 454

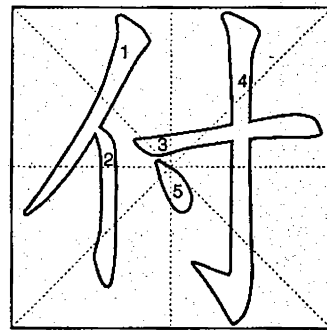

付 fù 455

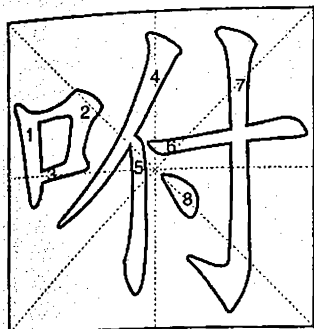

咐 fù 456

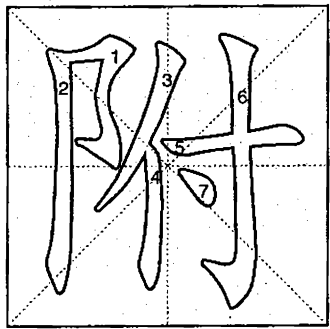

附 fù 457

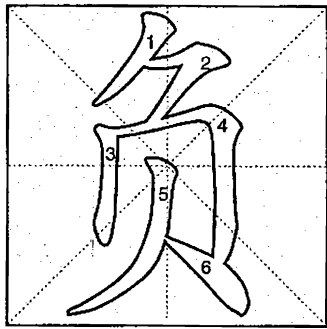

负 fù 458

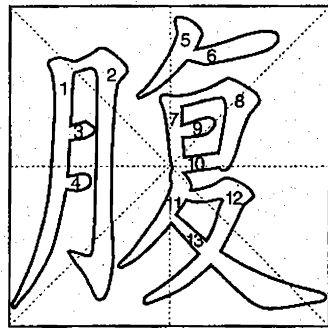

腹 fù 459

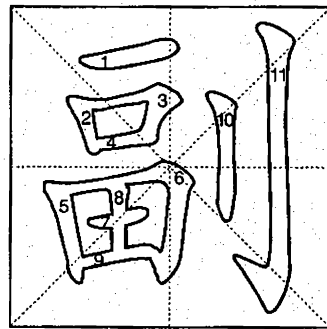

副 fù 460

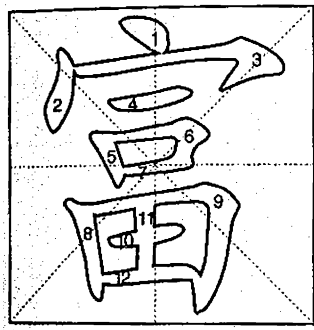

富 fù 461

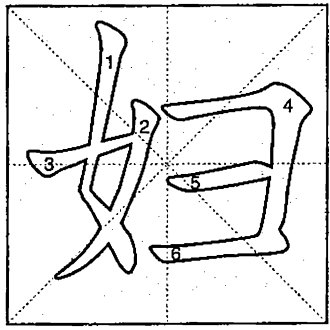

妇 fù 462

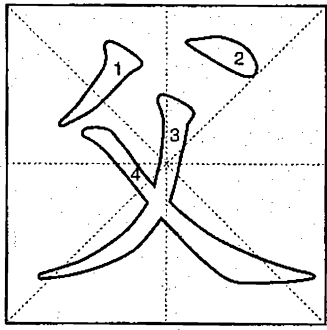

父 fù 463

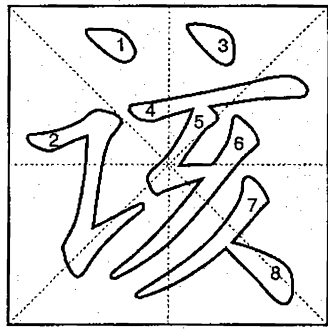

该 gāi 464

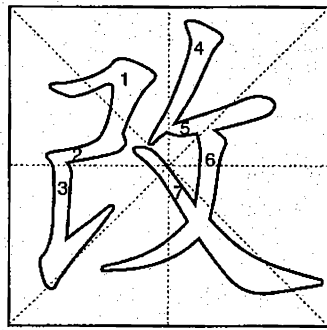

改 gǎi 465

### 付 fù

- ①hand over to; commit to  
②pay  
付出 fù'chū  
pay; expend  
付款 fù'kuǎn  
pay a sum of money  
付清 fù'qīng  
pay off; clear(a bill)

### 傅 fù

- ①teach; instruct ②teacher; instructor ③lay on; apply

### 复 fù

- ①duplicate ②compound; complex ③turn round; turn over ④answer; reply ⑤recover; resume ⑥revenge ⑦again  
复查 fù'chú  
check; reexamine  
复工 fù'gōng  
return to work  
复习 fù'xí  
review; revise

### 腐 fǔ

- rotten; putrid; stale; corroded  
腐败 fǔ'bài  
rotten; decayed; putrid  
腐烂 fǔ'làn  
decomposed; putrid  
腐朽 fǔ'xiǔ  
rotten; decayed

### 俯 fǔ

- bow(one's head)  
俯冲 fǔ'chōng  
dive  
俯身 fǔ'shēn  
bend; bow; stoop  
俯视 fǔ'shì  
look down at; overlook

### 副 fù

- ①deputy; assistant ②auxiliary; subsidiary; secondary ③correspond to; fit  
副本 fù'běn  
copy; duplicate  
副产品 fù'chǎn'pǐn  
by-product  
副食 fù'shí  
non-staple food

### 腹 fù

- belly; abdomen; stomach  
腹部 fù'bù  
abdomen  
腹地 fù'dì  
hinterland  
腹泻 fù'xiè  
diarrhoea

### 负 fù

- ①shoulder; bear ②have at one's back; rely on ③suffer ④enjoy ⑤owe  
负担 fù'dān  
bear; load; shoulder  
负片 fù'piàn  
negative  
负重 fù'zhòng  
bear a heavy burden

### 附 fù

- ①add; attach; enclose ②get close to; be near ③agree to  
附表 fù'biǎo  
attached list  
附件 fù'jiàn  
appendix; annex  
附近 fù'jìn  
nearby; close to

### 咐 fù

- 吩咐 fēn'fù  
tell; instruct  
嘱咐 zhǔ'fù  
tell; exhort

### 改 gǎi

- ①change; transform ②alter; revise ③correct; rectify; put right ④switch over to (doing sth. else)  
改变 gǎi'biàn  
change; alter  
改革 gǎi'gé  
reform  
改写 gǎi'xiě  
rewrite; adapt

### 该 gāi

- ①ought to; should ②be sb.'s turn to do sth. ③deserve ④most likely; ⑤owe ⑥this; that  
该死 gāi'sǐ  
damn

### 父 fù

- father  
父辈 fù'bèi  
older generation  
父母 fù'mǔ  
father and mother  
父亲 fù'qīn  
father

### 妇 fù

- ①woman ②married woman  
③wife  
妇科 fù'kē  
gynecology  
妇女 fù'nǚ  
woman  
妇幼 fù'yòu  
women and children

### 富 fù

- rich; wealthy; abundant  
富贵 fù'guì  
riches and honour  
富矿 fù'kuàng  
rich ore  
富强 fù'qiáng  
prosperous and strong

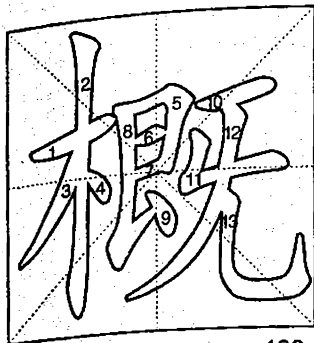

概 gài 466

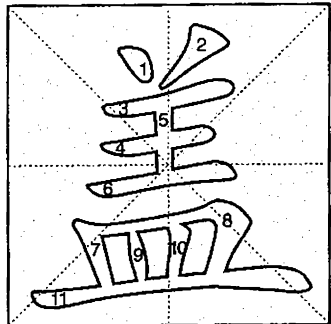

盖 gài 467

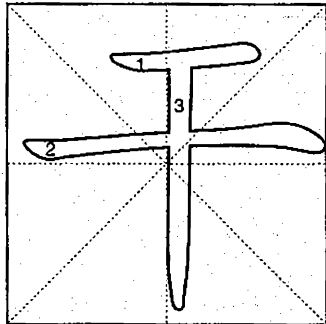

干 gān 468

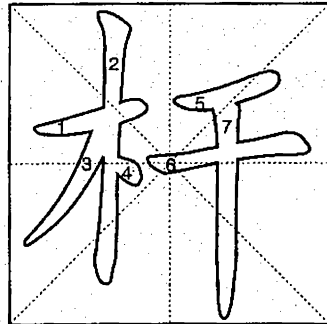

杆 gān 469

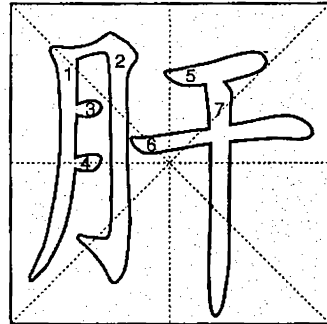

肝 gān 470

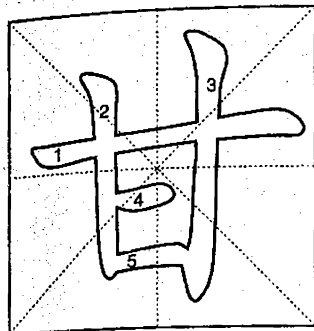

甘 gān 471

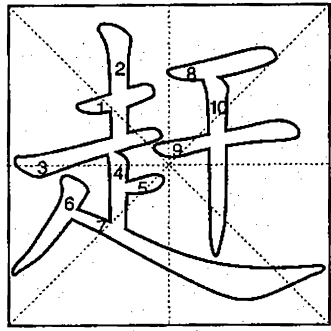

赶 gǎn 472

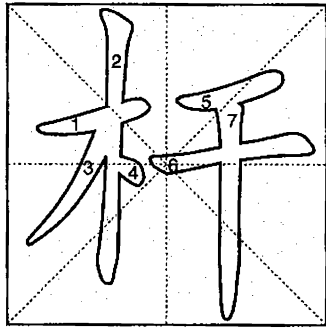

杆 gǎn 473

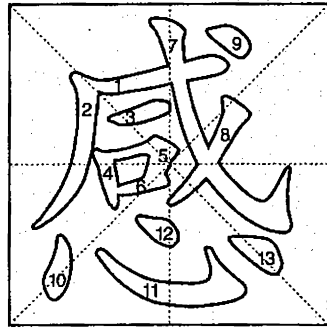

感 gǎn 474

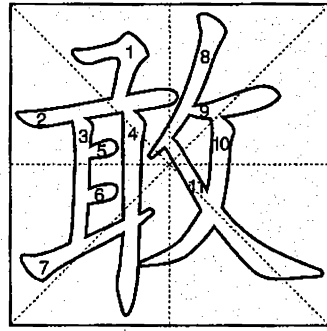

敢 gǎn 475

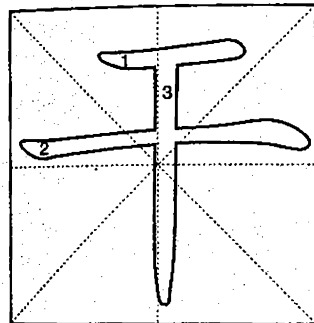

干 gàn 476

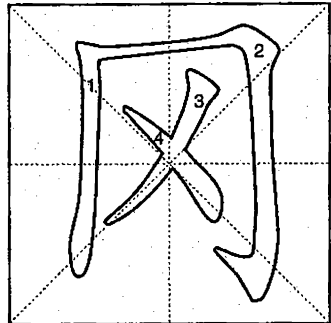

冈 gāng 477

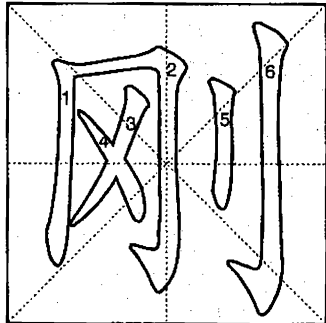

刚 gāng 478

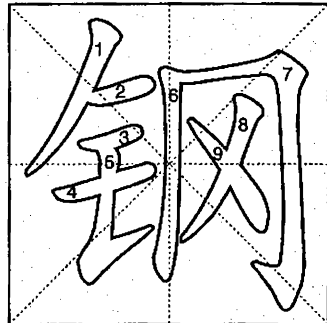

钢 gāng 479

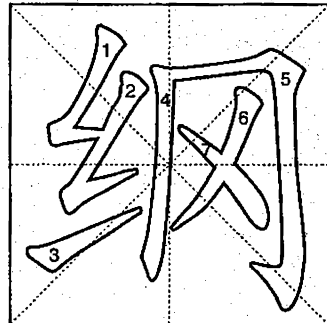

纲 gāng 480

### 肝 gān

liver  
 肝癌 gān'ái  
 cancer of the liver  
 肝炎 gān'yán  
 hepatitis  
 肝脏 gān'zàng  
 liver

### 杆 gān

pole; staff  
 杆子 gān'zi  
 pole

### 干 gān

①be concerned with ②dry  
 ③dried food ④empty; hollow; dry  
 ⑤taken into nominal kinship  
 ⑥(do sth.) for nothing; futilely  
 干杯 gān'bēi  
 drink a toast  
 干草 gān'cǎo  
 hay  
 干冷 gān'lěng  
 dry and cold

### 盖 gài

①lid; cover ②cover ③affix (a seal) ④build  
 盖房 gài'fáng  
 build a house  
 盖章 gài'zhāng  
 seal; stamp  
 盖子 gài'zi  
 lid; cover; cap; top

### 概 gài

①general; approximate  
 ②without exception; categorically  
 概况 gài'kuàng  
 general situation; survey  
 概论 gài'lùn  
 outline; introduction  
 概要 gài'yào  
 essentials

### 敢 gǎn

①bold; courageous; daring  
 ②dare to ③have the confidence to; be certain  
 敢死队 gǎn'sǐ duì  
 dare-to-die corps  
 敢于 gǎn'yú  
 be bold in  
 敢作敢为 gǎn'zuò gǎn'wéi  
 dare to do everything

### 感 gǎn

①feel; sense ②move; touch; affect ③be grateful; be obliged  
 ④sense; feeling  
 感动 gǎn'dòng  
 move; touch  
 感冒 gǎn'mào  
 common cold  
 感谢 gǎn'xiè  
 thank; be grateful

### 杆 gǎn

the shaft or arm of sth.  
 笔杆 bǐ'gǎn  
 penholder; pen

### 赶 gǎn

①catch up with; overtake ②try to catch; make a dash for; rush for  
 ③hurrythrough ④drive ⑤drive away; expel  
 赶快 gǎn'kuài  
 at once; quickly  
 赶路 gǎn'lù  
 hurry on one's way  
 赶巧 gǎn'qiǎo  
 happen to

### 甘 gān

①sweet; pleasant ②willingly  
 one's own accord  
 甘苦 gān'kǔ  
 joys and sorrows  
 甘心 gān'xīn  
 willingly; readily  
 甘蔗 gān'zhe  
 sugarcane

### 纲 gāng

①the headrope of a fishing net  
 ②key link; guiding principle  
 ③outline; programme  
 纲领 gāng'lǐng  
 guiding principle  
 纲要 gāng'yào  
 outline; sketch

### 钢 gāng

steel  
 钢板 gāng'bǎn  
 steel plate  
 钢笔 gāng'bǐ  
 pen; fountain pen  
 钢轨 gāng'guǐ  
 rail

### 刚 gāng

①firm; strong; indomitable  
 ②just; exactly ③barely; only just  
 ④only a short while ago; just  
 刚才 gāng'cái  
 just now; a moment ago  
 刚好 gāng'hǎo  
 just; exactly  
 刚强 gāng'qiáng  
 firm; staunch

### 冈 gāng

山冈 shān'gāng  
 low hill

### 干 gàn

①trunk; main part ②cadre  
 ③do; work ④fight; strike ⑤capable; able  
 干部 gàn'bù  
 cadre  
 干掉 gàn'diào  
 kill; get rid of  
 干活 gàn'huó  
 work; work on a job

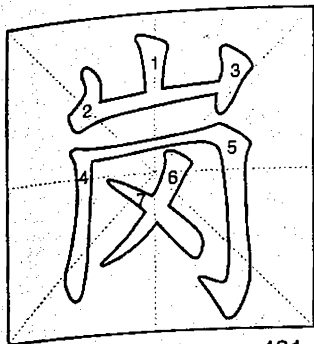

岗 gǎng 481

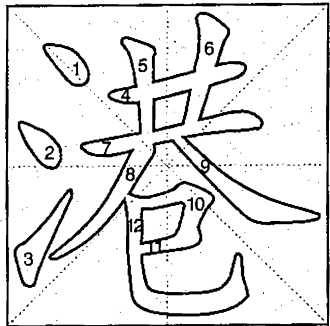

港 gǎng 482

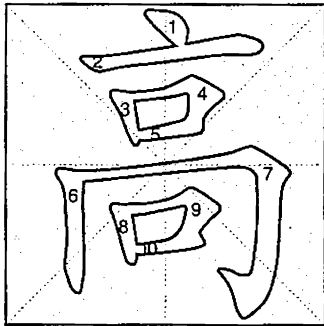

高 gāo 483

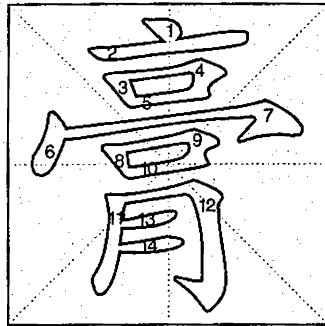

膏 gāo 484

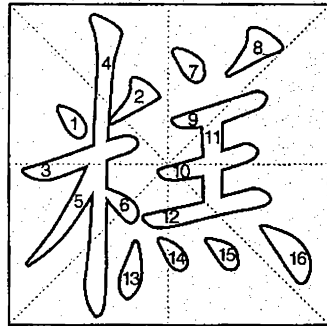

糕 gāo 485

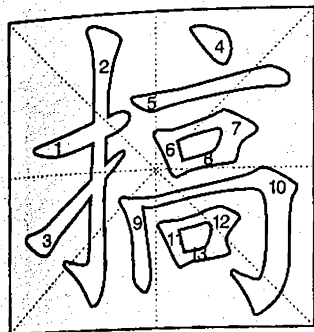

搞 gǎo 486

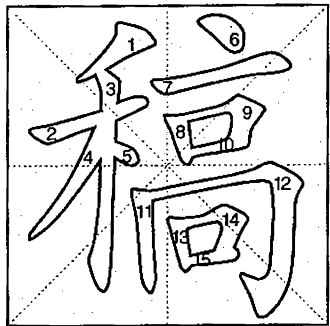

稿 gǎo 487

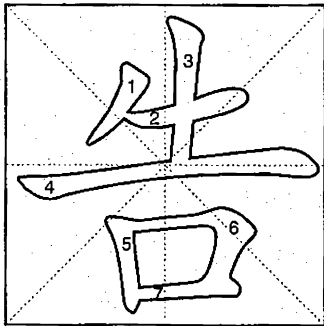

告 gào 488

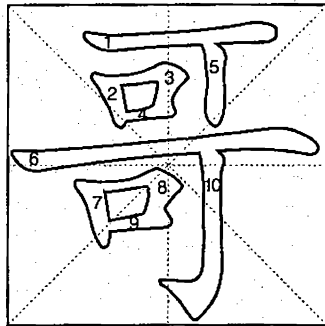

哥 gē 489

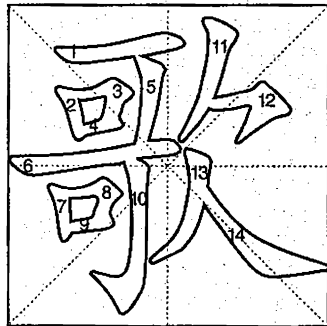

歌 gē 490

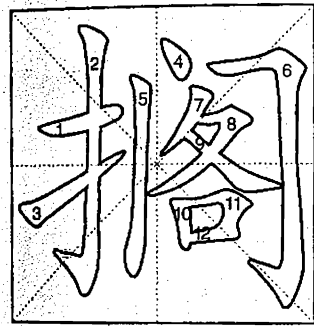

搁 gē 491

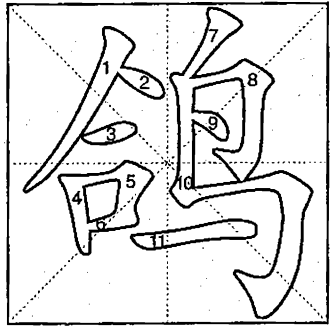

鸽 gē 492

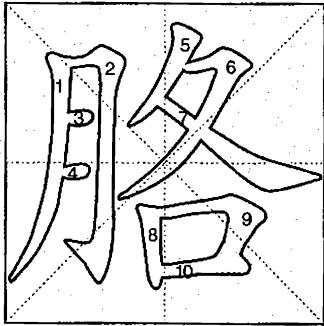

咯 gē 493

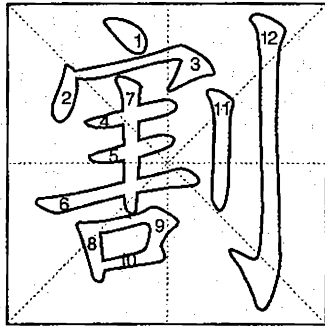

割 gē 494

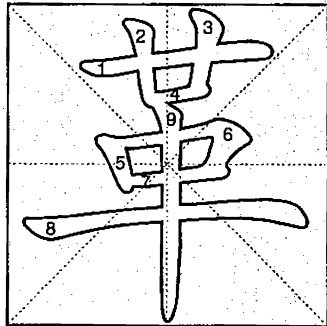

革 gé 495

### 糕 gāo

cake; pudding  
糕点 gāo'diǎn  
cake; pastry

### 膏 gāo

①fat; grease; oil ②paste; cream;  
ointment  
膏药 gāo'yao  
plaster

### 高 gāo

①tall; high ②of a high level or  
degree ③loud ④dear; expensive  
高唱 gāo'chàng  
sing loudly  
高档 gāo'dàng  
superior quality  
高血压 gāo'xuè'yā  
hypertension

### 港 gǎng

port; harbour  
港币 gǎng'bì  
Hong Kong dollar  
港口 gǎng'kǒu  
port; harbour  
港湾 gǎng'wān  
harbour

### 岗 gǎng

①hillock; mound  
②ridge  
③sentry; post  
岗楼 gǎng'lóu  
watchtower  
岗亭 gǎng'tíng  
sentry box; police box  
岗位 gǎng'wèi  
post; station

### 歌 gē

①song ②sing  
歌剧 gē'jù  
opera  
歌曲 gē'qǔ  
song  
歌星 gē'xīng  
a singing star

### 哥 gē

(elder) brother  
哥哥 gē'ge  
(elder) brother  
哥们儿 gē'r'men  
brothers; buddies

### 告 gào

①tell; inform; notify ②accuse;  
go to law against; bring an action  
against ③ask for; request; solicit  
④declare; announce  
告别仪式 gào'bié'yí'shì  
farewell ceremony  
告急 gào'jí  
report an emergency  
告诫 gào'jiè  
warn

### 稿 gǎo

①draft; sketch ②manuscript; orig-  
inal text  
稿费 gǎo'fèi  
contribution fee  
稿件 gǎo'jiàn  
manuscript  
稿纸 gǎo'zhǐ  
writing paper

### 搞 gǎo

①do; carry on; be engaged in  
②make; produce; work out ③set  
up; start ④get; get hold of; secure  
⑤cause to become  
搞错 gǎo'cuò  
mistake  
搞鬼 gǎo'guǐ  
play tricks  
搞坏 gǎo'huài  
damage; impair

### 革 gé

①leather; hide ~ 制品 leather  
goods ~ 履 leather shoes ②change;  
transform ③remove from office; ex-  
pel  
革命 gé'mìng  
revolution  
革新 gé'xīn  
innovation  
革职 gé'zhí  
remove from office

### 割 gē

cut  
割草机 gē'cǎo'jī  
mower  
割除 gē'chú  
cut off; cut out  
割舍 gē'shě  
give up

### 胳膊 gē

胳膊 gē'bo  
arm  
胳膊肘儿 gē'bo'zhǒu'er  
elbow

### 鸽 gē

pigeon; dove  
鸽子 gē'zi  
pigeon; dove

### 搁 gē

①put ②put aside; leave over;  
shelve  
搁浅 gē'qiǎn  
run aground  
搁置 gē'zhì  
shelve; lay aside

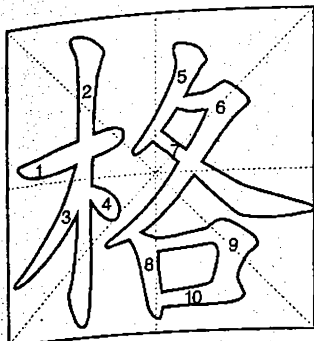

格 gé 496

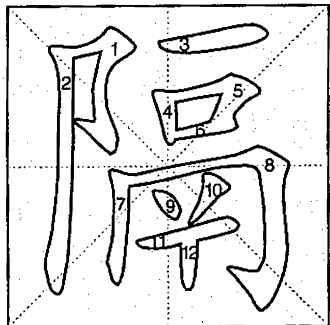

隔 gé 497

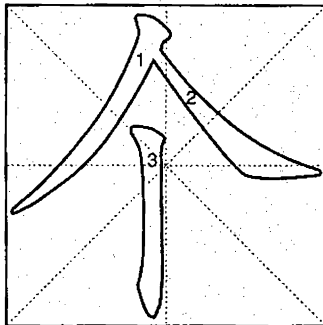

个 gè 498

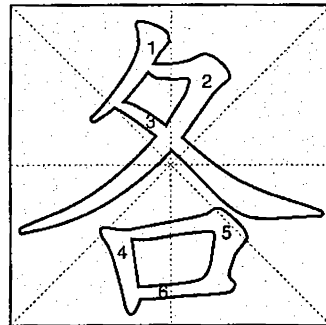

各 gè 499

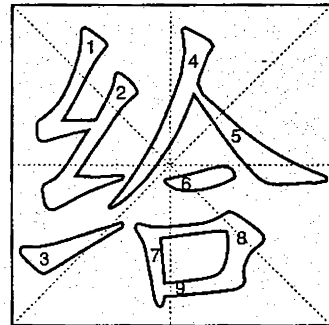

给 gěi 500

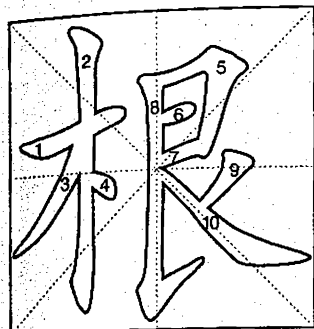

根 gēn 501

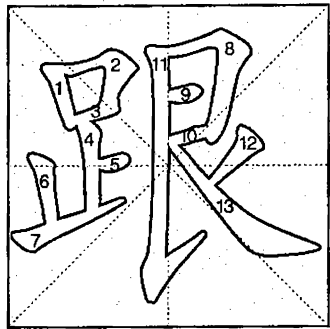

跟 gēn 502

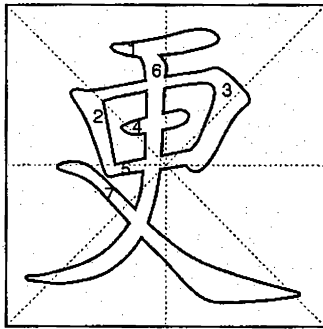

更 gēng 503

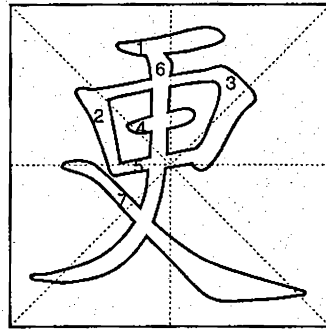

更 gèng 504

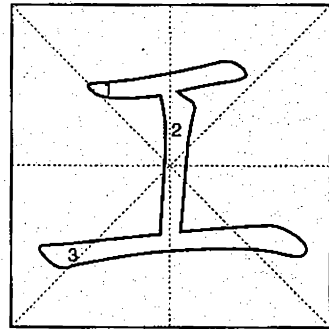

工 gōng 505

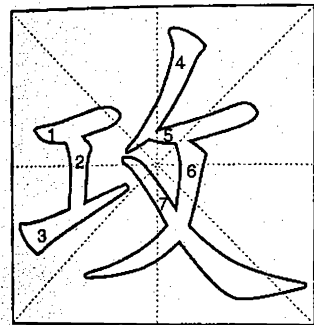

攻 gōng 506

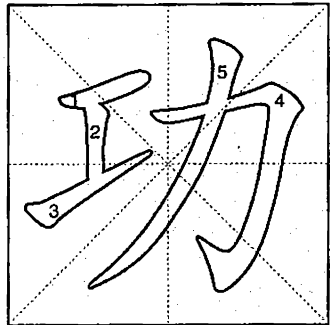

功 gōng 507

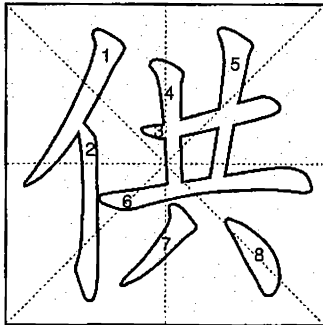

供 gòng 508

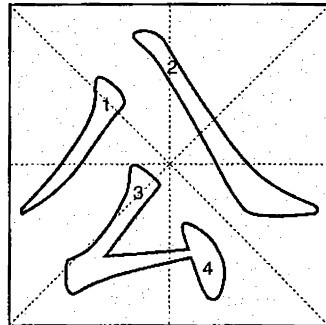

公 gōng 509

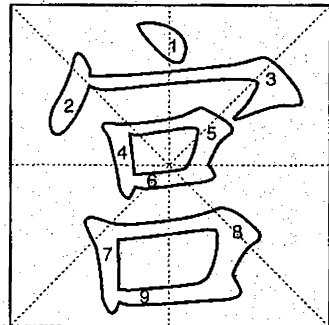

宫 gōng 510



### 给 gěi

① give; grant ② for; for the benefit of ③ let; allow  
 给以 gěi'yǐ  
 give; grant

### 各 gè

each; every; various; different  
 parts of the country  
 各地 gè'dì  
 everywhere  
 各个 gè'gè  
 each; every; various  
 各界 gè'jiè  
 all circles

### 个 gè

个人财产 gè'rén'cái'chǎn  
 personal property  
 个人主义 gè'rén'zhǔ'yì  
 individualism  
 个体 gè'tǐ  
 individual

### 隔 gé

① separate; partition ② at a distance from  
 隔壁 gé'bì  
 next door  
 隔离 gé'lí  
 keep apart; isolate  
 隔音 gé'yīn  
 sound insulation

### 格 gé

① squares formed by crossed lines; check ② division (horizontal or otherwise) ③ standard; pattern  
 style ④ case  
 格斗 gé'dòu  
 grapple; wrestle  
 格式 gé'shì  
 form; pattern  
 格言 gé'yán  
 maxim; motto

### 工 gōng

① worker; the working class  
 ② work; labour ③ (construction) project ④ industry ⑤ man-day ⑥ skill; craftsmanship ⑦ be good at  
 工厂 gōng'chǎng  
 factory; mill; plant  
 工资 gōng'zī  
 wages; pay  
 工作证 gōng'zuò'zhèng  
 I.D. card

### 更 gèng

① more; still more ② further; furthermore  
 更多 gèng'duō  
 more; still more  
 更好 gèng'hǎo  
 better  
 更加 gèng'jiā  
 more; still more

### 更 gēng

① change; replace ② watch  
 更动 gēng'dòng  
 change; alter  
 更改 gēng'gǎi  
 change; alter  
 更年期 gēng'nián'qī  
 menopause

### 跟 gēn

① heel ② follow ③ with; about; as ④ and  
 跟从 gēn'cóng  
 keep track of; shadow; tail  
 跟前 gēn'qián  
 in front of; near  
 跟上 gēn'shàng  
 keep pace with

### 根 gēn

① root; foot; base ② cause; origin  
 source ③ thoroughly; completely  
 根本 gēn'běn  
 basic; at all  
 根基 gēn'jī  
 foundation; basis  
 根源 gēn'yuán  
 source; origin; root

### 宫 gōng

palace  
 宫灯 gōng'dēng  
 palace lantern  
 宫殿 gōng'diàn  
 palace  
 宫女 gōng'nǚ  
 maid of honour

### 公 gōng

① public; state-owned; collective~与私 public and private(interests) ② common; general ③ metric  
 ④ make public  
 公尺 gōng'chǐ  
 metre  
 公告 gōng'gào  
 announcement  
 公共 gōng'gòng  
 public; common

### 供 gōng

① supply; feed ② for (the use or convenience of)  
 供电 gōng'diàn  
 power supply  
 供销 gōng'xiāo  
 supply and marketing  
 供应 gōng'yìng  
 supply

### 功 gōng

① meritorious service; merit; exploit ② achievement; result ③ skill  
 功夫 gōng'fu  
 time; kung fu; skill  
 功劳 gōng'láo  
 contribution; credit  
 功能 gōng'néng  
 function

### 攻 gōng

① attack; take the offensive  
 ② accuse; charge ③ study  
 攻打 gōng'dǎ  
 attack; assault  
 攻读 gōng'dú  
 assiduously study  
 攻克 gōng'kè  
 capture; take

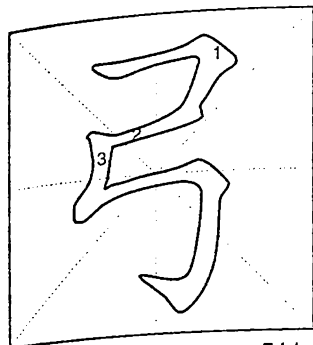

弓 gōng 511

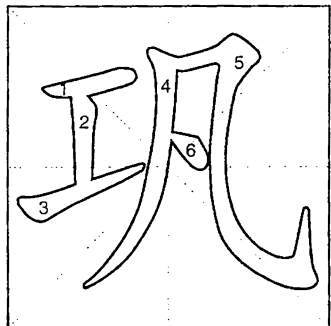

巩 gǒng 512

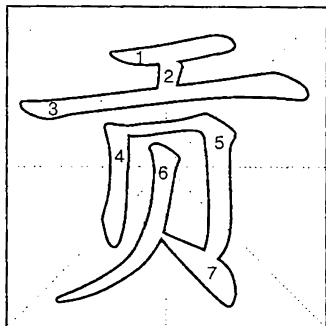

贡 gòng 513

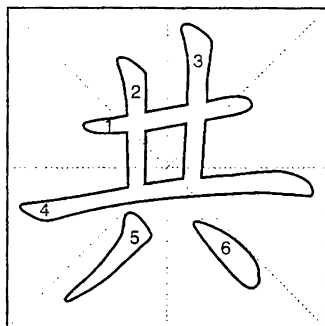

共 gòng 514

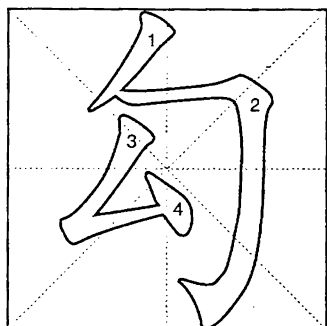

勾 gōu 515

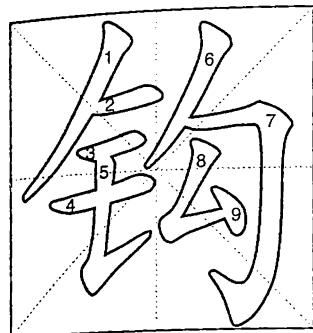

钩 gōu 516

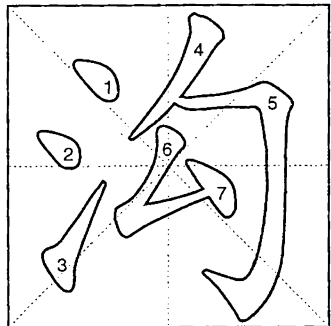

沟 gōu 517

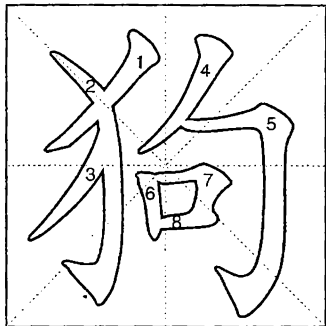

狗 gǒu 518

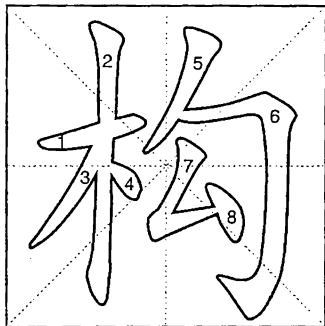

构 gòu 519

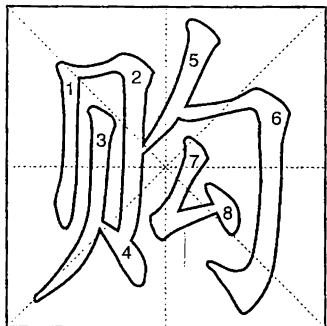

购 gòu 520

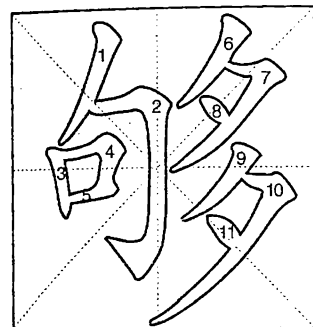

够 gòu 521

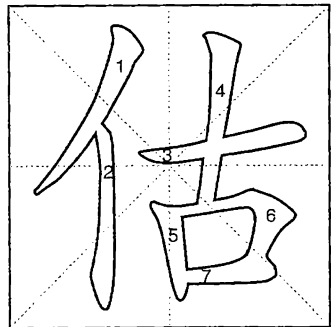

估 gū 522

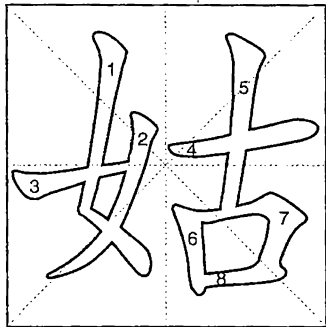

姑 gū 523

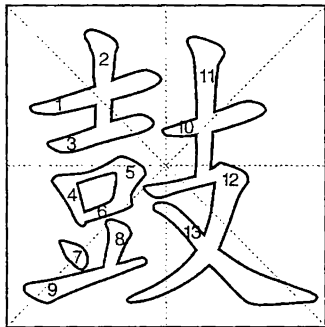

鼓 gǔ 524

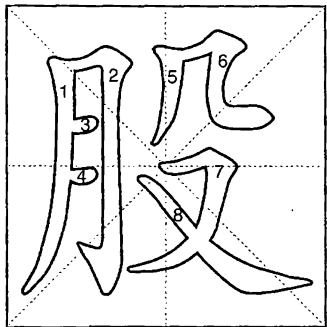

股 gǔ 525

### 勾 gōu

① cancel; cross out; strike out; tick off ② delineate; draw ③ induce; evoke; call to mind ④ col-lude with  
 勾结 gōu'jié  
 collaborate with  
 勾心斗角 gōu'xīn'dòu'jiǎo  
 jockey for position  
 勾引 gōu'yǐn  
 tempt; entice; seduce

### 共 gòng

① common; general ② share ③ doing the same thing; together ④ altogether; in all; all told  
 共和国 gòng'hé'guó  
 republic  
 共事 gòng'shì  
 work together  
 共享 gòng'xiǎng  
 enjoy together; share

### 贡 gòng

tribute  
 贡品 gòng'pǐn  
 articles of tribute  
 贡献 gòng'xiàn  
 contribute; dedicate

### 巩 gǒng

consolidate  
 巩固 gǒng'gù  
 consolidate; strengthen

### 弓 gōng

① bow ② bend; arch  
 弓箭 gōng'jiàn  
 bow and arrow  
 弓弦 gōng'xián  
 bowstring

### 购 gòu

buy  
 购买 gòu'mǎi  
 purchase; buy  
 购物中心 gòu'wù'zhōng'xīn  
 shopping center  
 购销 gòu'xiāo  
 purchase and sale

### 构 gòu

① construct; form; compose ② make up ③ literary composition  
 构件 gòu'jiàn  
 component  
 构想 gòu'xiǎng  
 an idea; a conception  
 构造 gòu'zào  
 structure

### 狗 gǒu

dog  
 狗胆包天 gǒu'dǎn'bāo'tiān  
 monstrous audacity  
 狗腿子 gǒu'tuǐ'zi  
 lackey; henchman  
 狗熊 gǒu'xióng  
 black bear; coward

### 沟 gōu

① ditch; channel; trench ② groove; rut; furrow ③ gully; ravine  
 沟壑 gōu'hè  
 gully; ravine  
 沟渠 gōu'qú  
 irrigation canals  
 沟通 gōu'tōng  
 link up

### 钩 gōu

① hook ② check mark; tick ③ secure with a hook; hook ④ (with large stitches) ⑤ crochet  
 钩针 gōu'zhēn  
 crochet hook  
 钩子 gōu'zi  
 hook

### 股 gǔ

① thigh ② section (of an office, enterprise, etc.) ③ strand; ply ④ one of several equal parts; share in a company  
 股东 gǔ'dōng  
 shareholder; stockholder  
 股民 gǔ'mín  
 stockholder  
 股市 gǔ'shì  
 the stock market

### 鼓 gǔ

① drum ② beat; strike; sound ③ blow with bellows, etc. ④ rouse; agitate; pluck up ⑤ bulge; swell  
 鼓风机 gǔ'fēng'jī  
 air-blower  
 鼓励 gǔ'li  
 encourage; urge  
 鼓掌 gǔ'zhǎng  
 clap one's hands

### 姑 gū

① father's sister; aunt ② husband's sister; sister-in-law  
 姑母 gū'mǔ  
 aunt  
 姑娘 gū'niang  
 girl; daughter  
 姑爷 gū'ye  
 son-in-law

### 估 gū

appraise  
 估计 gū'jì  
 estimate; appraise; reckon  
 估价 gū'jià  
 appraise; evaluate  
 估量 gū'liáng  
 appraise; estimate

### 够 gòu

① enough; sufficient; adequate ② reach; be up to (a certain standard, etc.) ③ quite; rather  
 够本 gòu'běn  
 break even  
 够格 gòu'gé  
 be up to standard  
 够朋友 gòu'péng'yǒu  
 be a friend indeed

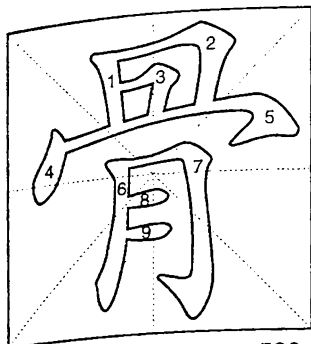

骨 gǔ 526

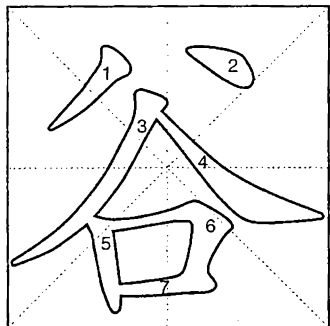

谷 gǔ 527

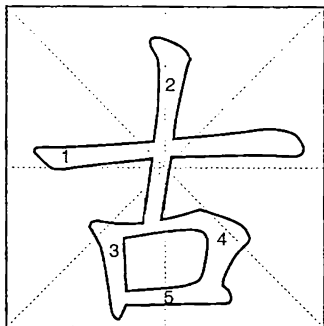

古 gǔ 528

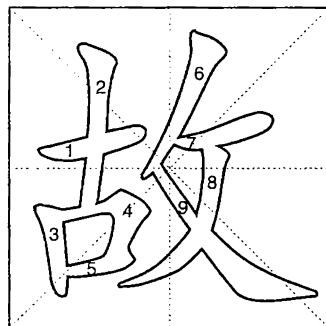

故 gù 529

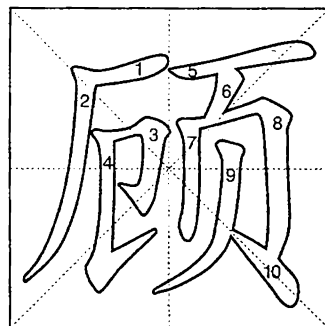

顾 gù 530

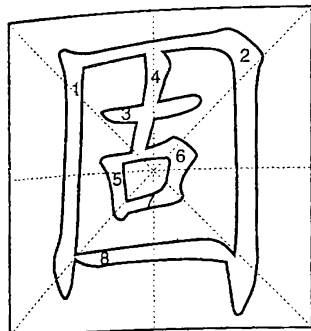

固 gù 531

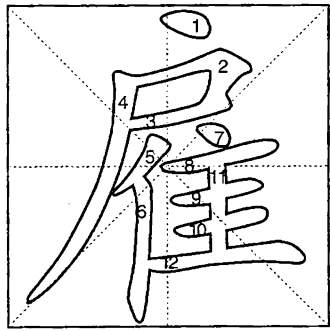

雇 gù 532

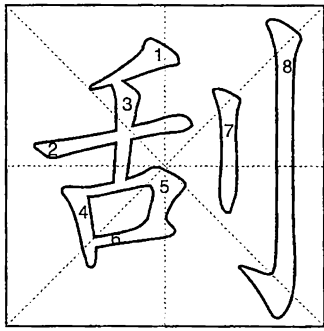

刮 guā 533

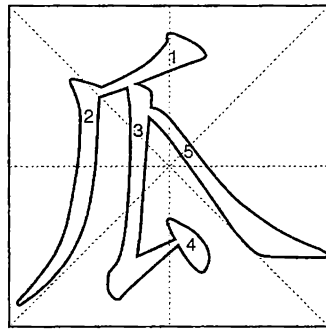

瓜 guā 534

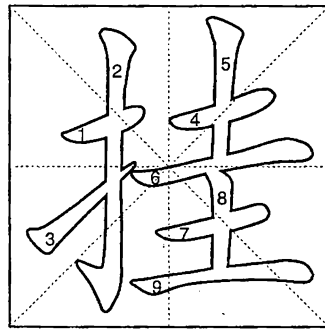

挂 guà 535

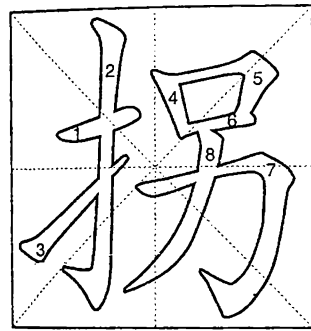

拐 guǎi 536

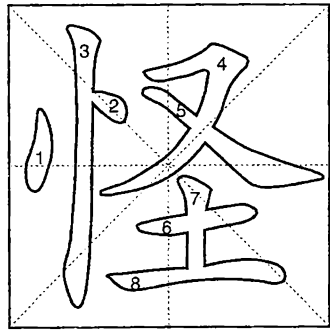

怪 guài 537

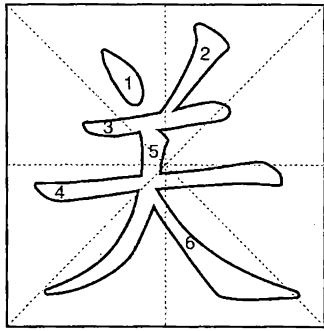

关 guān 538

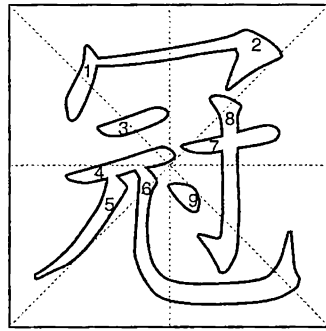

冠 guān 539

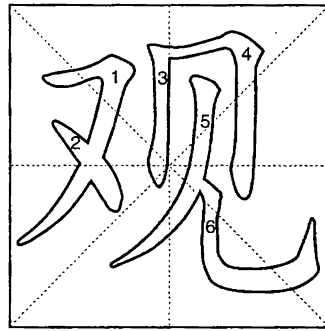

观 guān 540

### 顾 gù

- ①turn round and look at; look at  
②attend to; take into consideration

顾客 gù'kè  
customer; shopper  
顾虑 gù'lǜ  
misgiving  
顾主 gù'zhǔ  
customer; client; patron

### 故 gù

- ①incident; happening ②reason;  
cause ③on purpose; intentionally  
④hence; therefore; for this reason  
故宫博物院 gù'gōng'bó'wù'guǎn  
the Palace Museum  
故事 gù'shi  
story; tale  
故土 gù'tǔ  
native land

### 古 gǔ

- ancient; age-old  
古典文学 gǔ'diǎn'wén'xué  
classical literature  
古董 gǔ'dǒng  
antique; curio  
古迹 gǔ'jì  
historic site

### 谷 gǔ

- ①valley; gorge ②cereal; grain  
③millet  
谷仓 gǔ'cāng  
granary; barn  
谷物 gǔ'wù  
cereal; grain  
谷子 gǔ'zi  
millet; unhusked rice

### 骨 gǔ

- ①bone ②skeleton; framework  
③character; spirit  
骨刺 gǔ'cì  
spur  
骨骼 gǔ'gé  
skeleton  
骨头 gǔ'tou  
bone; character

### 挂 guà

- ①hang; put up ②hitch; get  
caught ③ring off ④call up; put  
sb. through to ⑤be concerned about  
⑥register (at a hospital, etc.)  
挂挡 guà'dǎng  
put into gear  
挂号 guà'hào  
register  
挂钟 guà'zhōng  
wall clock

### 瓜 guā

- melon, gourd, etc. 冬~ white  
gourd 西~ water melon  
瓜分 guā'fēn  
carve up; divide up  
瓜果 guā'guǒ  
melon and fruit  
瓜子 guā'zi  
melon seeds

### 刮 guā

- ①scrape ②smear with (paste,  
etc.) ③plunder; fleece ④blow  
刮刀 guā'dāo  
scraper  
刮风 guā'fēng  
blow  
刮脸 guā'liǎn  
shave (the face)

### 雇 gù

- hire; employ  
雇农 gù'nóng  
farmhand  
雇佣军 gù'yōng'jūn  
mercenary army  
雇主 gù'zhǔ  
employer

### 固 gù

- ①solid; firm  
②firmly; resolutely  
③solidify; consolidate  
固定 gù'dìng  
fixed; regular  
固定工资 gù'dìng'gōng'zī  
regular pay  
固体 gù'tǐ  
solid (body)

### 观 guān

- ①look at; watch; observe  
②sight; view ③outlook; view;  
concept  
观光 guān'guāng  
go sightseeing; visit; tour  
观看 guān'kàn  
watch; view  
观赏 guān'shǎng  
view and admire

### 冠 guān

- ①hat ②corona; crown (of a tree)  
③crest; (cock's)comb  
冠冕堂皇 guān'miǎn'táng'huáng  
highfalutin; high-sounding  
冠状动脉(解)  
guān'zhuàng' dòng' mài' (jiě)  
coronary artery

### 关 guān

- ①shut; close ②turn off ③lock  
up (in prison); shut in ④close  
down ⑤pass 把~guard the pass  
关门 guān'mén  
close; bolt the door  
关心 guān'xīn  
be concerned with  
关照 guān'zhào  
look after

### 怪 guài

- ①strange; odd; queer; bewildering  
②monster; demon; evil being  
③blame  
怪话 guài'huà  
cynical remark  
怪物 guài'wū  
monster; freak  
怪异 guài'yì  
monstrous; unusual

### 拐 guǎi

- ①turn ②limp ③crutch  
④abduct; kidnap ⑤swindle; make  
off with  
拐角 guǎi'jiǎo  
corner; turning  
拐弯 guǎi'wān  
turn (a corner)  
拐杖 guǎi'zhàng  
walking stick

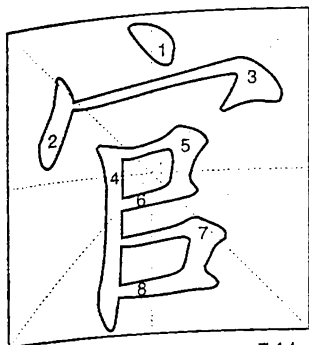

官 guān 541

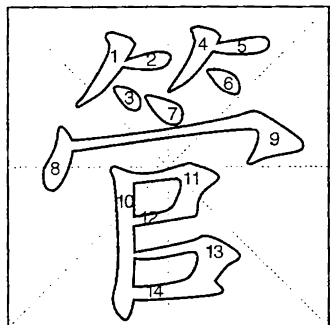

管 guǎn 542

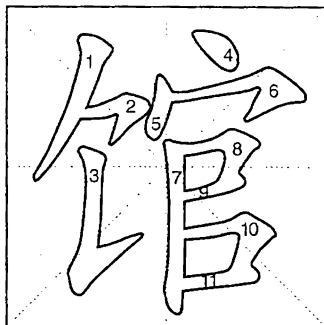

馆 guǎn 543

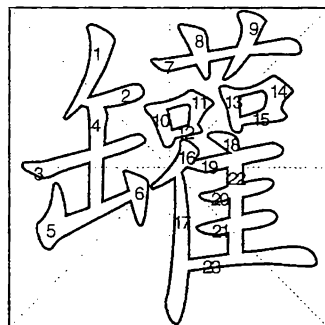

罐 guàn 544

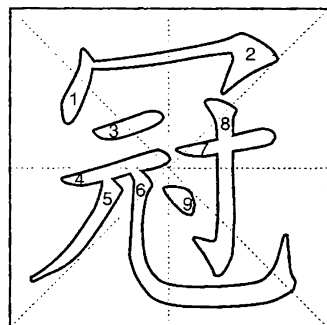

冠 guàn 545

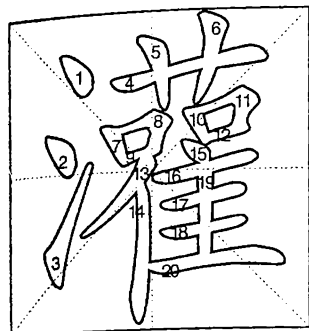

灌 guàn 546

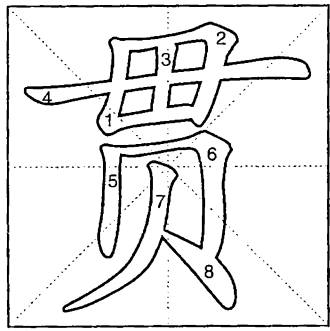

贯 guàn 547

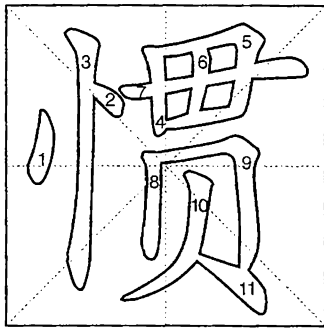

惯 guàn 548

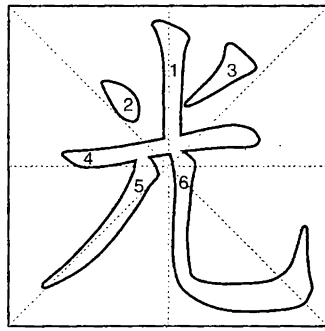

光 guāng 549

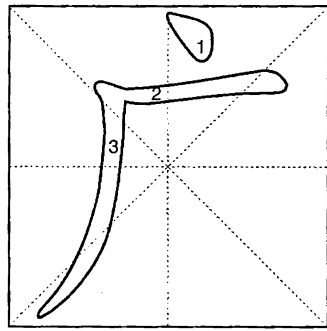

广 guǎng 550

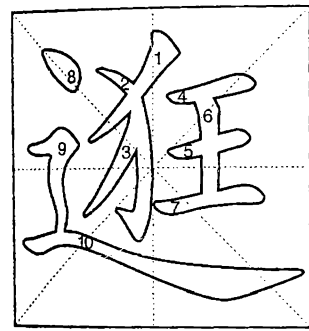

逛 guàng 551

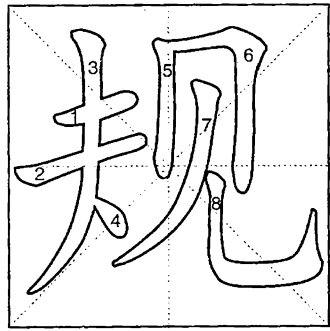

规 guī 552

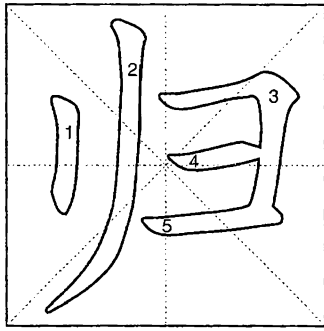

归 guī 553

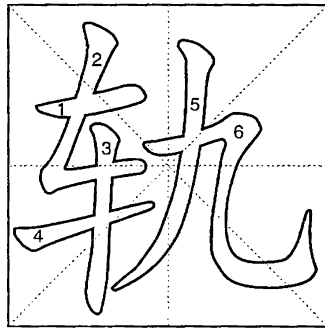

轨 guǐ 554

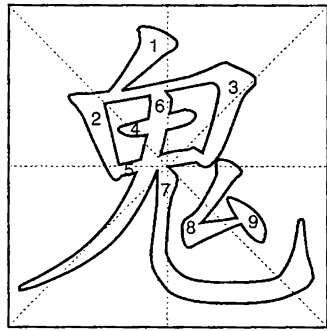

鬼 guǐ 555

### 冠 guān

precede; crown with; first place; the best

冠词(语) guān'cí(yǔ)  
article

冠军 guān'jūn  
champion

冠名权 guān'míng'quán  
right to name

### 罐 guàn

jar; pot; tin  
罐头 guān'tóu  
tin; can  
罐子 guān'zi  
pitcher; jug; pot

### 馆 guǎn

①accommodation for guests  
②embassy, legation or consulate  
③shop ④a place for cultural activities  
馆子 guǎn'zi  
restaurant

### 管 guǎn

①tube; pipe ②wind instrument  
③valve; tube ④manage; run; be in charge of ⑤subject sb. to discipline  
管道 guǎn'dào  
pipeline; piping; tubing  
管理 guǎn'lǐ  
manage; run  
管子 guǎn'zi  
tube; pipe

### 官 guān

①government official; officer  
一致 unity between officers  
men ②organ 感~ sense organ  
官司 guān'sī  
lawsuit  
官员 guān'yuán  
official  
官职 guān'zhí  
official position

### 广 guǎng

①wide; vast; extensive ②numerous ③expand; spread

广播 guǎng'bō  
broadcast

广场 guǎng'chǎng  
public square; square

广告 guǎng'gào  
advertisement

### 光 guāng

①light; ray ②brightness; lustre  
③honour; glory ④scenery  
⑤smooth; glossy; polished ⑥used up; nothing left

光碟(盘) guāng'dié(pán)  
CD

光明 guāng'míng  
light; bright; promising

光速 guāng'sù  
light speed

### 惯 guàn

①be used to; be in the habit of  
②indulge; spoil (a child)

惯技 guàn'jì  
old trick

惯偷 guàn'tōu

confirmed thief  
惯用法 guàn'yòng'fǎ  
usage

### 贯 guàn

①pass through; pierce ②be linked together ③birthplace; native place; place of one's birth or origin

贯彻 guàn'chè  
carry out (或 through)

贯串 guàn'chuàn  
run through; permeate

贯通 guàn'tōng  
be well versed in

### 灌 guàn

①irrigate ②fill; pour

灌溉 guàn'gài  
irrigate

灌木 guàn'mù  
bush; shrub

灌醉 guàn'zuì  
get sb. drunk

### 鬼 guǐ

①ghost; spirit; apparition  
②stealthy; surreptitious  
③sinister plot; dirty trick  
④terrible; damnable; horrible

鬼点子 guǐ'diǎn'zi  
wicked idea; trick

鬼话 guǐ'huà  
lie

鬼脸 guǐ'liǎn  
funny face; grimace

### 轨 guǐ

①rail; track ②course; path  
轨道 guǐ'dào  
track; orbit

轨道站(天) guǐ'dào'zhàn(tiān)  
orbit station

轨迹 guǐ'jì  
locus; (天)orbit

### 归 guī

①go back to; return ②give back to; return sth. to (its rightful owner, etc.) ③converge; come together

归档 guī'dàng  
place on file; file

归国 guī'guó  
return to one's country

归来 guī'lái  
go back; return

### 规 guī

①compasses; dividers ②regulation; rule ③advise ④map out ⑤gauge

规定 guī'dìng  
stipulate; provide; fix

规划 guī'huà  
programme; plan

规章 guī'zhāng  
rules; regulations

### 逛 guàng

stroll; ramble; roam  
逛荡 guàng'dàng  
loiter; loaf about

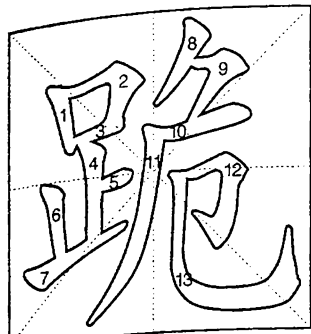

跪 guì 556

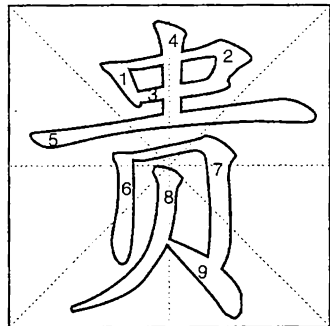

贵 guì 557

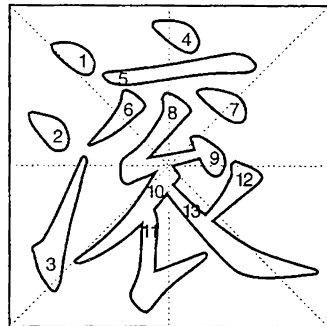

滚 gǔn 558



锅 guō 559

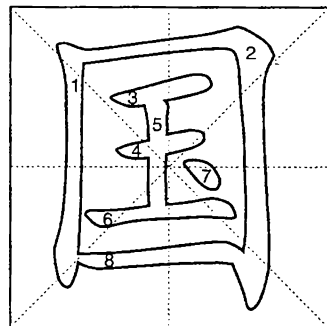

国 guó 560

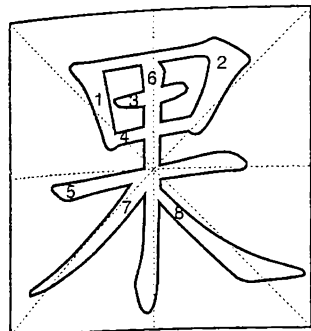

果 guǒ 561

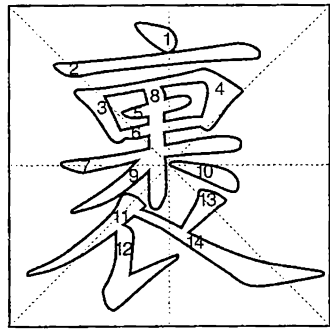

裹 guǒ 562

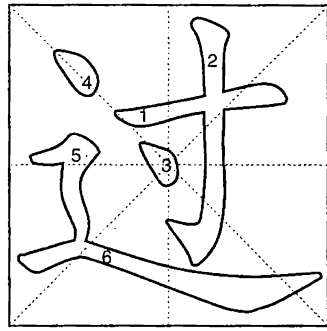

过 guò 563

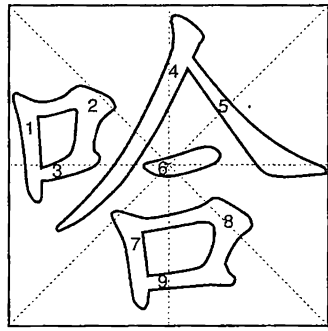

哈 hā 564

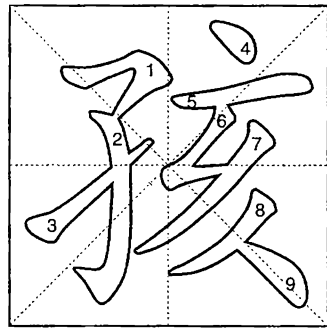

孩 hái 565

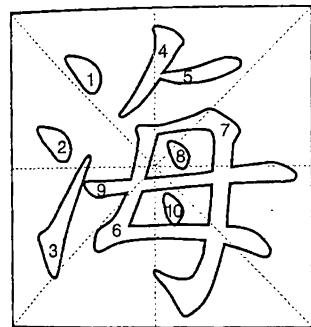

海 hǎi 566

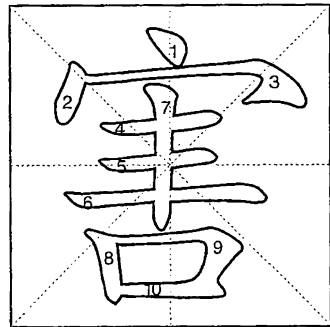

害 hài 567

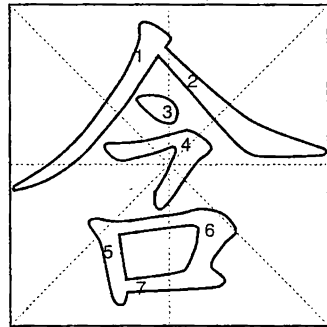

含 hán 568

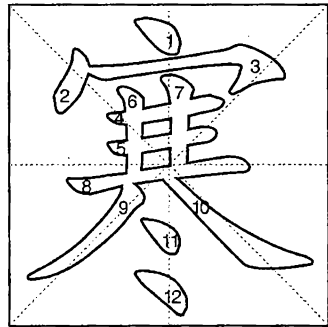

寒 hán 569

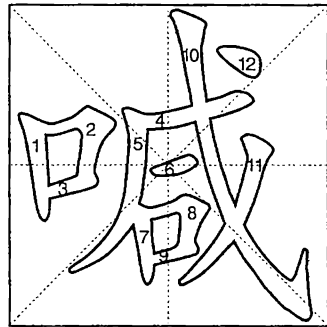

喊 hǎn 570



### 国 guó

- ①country; state; nation ②national  
③Chinese  
国宝 guó'bǎo  
national treasure  
国歌 guó'gē  
national anthem  
国画 guó'huà  
traditional Chinese painting

### 锅 guō

- ①pot, pan, boiler, cauldron, etc.  
②bowl (of a pipe, etc.)  
锅巴 guō'bā  
rice crust  
锅盖 guō'gài  
cover; lid  
锅炉 guō'lú  
boiler

### 滚 gǔn

- ①roll; trundle ②get away, beat it  
③bind; trim  
滚开 gǔn'kāi  
get away; get out  
滚筒 gǔn'tǒng  
cylinder; roll  
滚珠 gǔn'zhū  
ball

### 贵 guì

- ①expensive; costly; dear ②highly valued; worth; valuable; precious  
③noble ④your  
贵宾 guì'bīn  
honoured guest  
贵重 guì'zhòng  
valuable; precious  
贵族 guì'zú  
noble; aristocrat

### 跪 guì

- kneel; go down on one's knees  
跪拜 guì'bài  
kowitz  
跪姿 guì'zī  
kneeling position

### 孩 hái

- child  
孩子 hái'zi  
child; son or daughter  
孩子气 hái'zi'qì  
childishness

### 哈 hā

- ①breathe out (with the mouth open) ②aha ③ha-ha  
哈哈镜 hā'hā'jìng  
mirror of distortion  
哈气 hā'qì  
breathe out  
哈欠 hā'qiàn  
yawn

### 过 guò

- ①cross; pass ②across; past; through; over ③spend (time); pass (time) ④after; past ⑤undergo a process; go through  
过错 guò'cuò  
fault; mistake  
过境签证 guò'jìng'qiān'zhèng  
transit visa  
过年 guò'nián  
spend the New Year

### 裹 guǒ

- bind; wrap  
裹胁 guǒ'xié  
force to take part; coerce  
裹挟 guǒ'xié  
carry off; coerce

### 果 guǒ

- ①fruit ②result; consequence  
③determined ④really; sure enough  
⑤if indeed; if really  
果酱 guǒ'jiàng  
jam  
果品 guǒ'pǐn  
fruit  
果汁 guǒ'zhī  
fruit juice

### 喊 hǎn

- ①shout; cry out; yell ②call (a person)  
喊叫 hǎn'jiào  
shout; cry out

### 寒 hán

- ①cold ②tremble (with fear)  
③poor; needy ④humble  
寒冬 hán'dōng  
severe winter  
寒风 hán'fēng  
cold wind  
寒暑表 hán'shǔ'biǎo  
thermometer

### 含 hán

- ①keep in the mouth ②contain  
③nurture; cherish; harbour  
含量 hán'liàng  
content  
含怒 hán'nù  
in anger  
含义 hán'yì  
meaning; implication

### 害 hài

- ①evil; harm; calamity ②harmful; destructive; injurious ③do harm to; impair ④kill; murder  
害虫 hài'chóng  
injurious insect; pest  
害怕 hài'pà  
fear; be afraid; be scared  
害羞 hài'xiū  
be shy

### 海 hǎi

- ①sea or big lake ②a great number of people or things coming together ③extra large; of great capacity  
海岛 hǎi'dǎo  
island  
海盜 hǎi'dào  
pirate; sea rover  
海关 hǎi'guān  
customhouse; customs

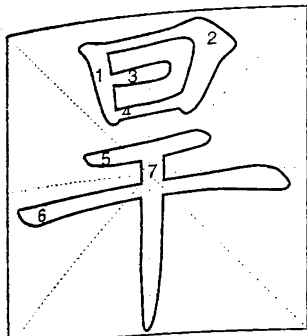

旱 hàn 571

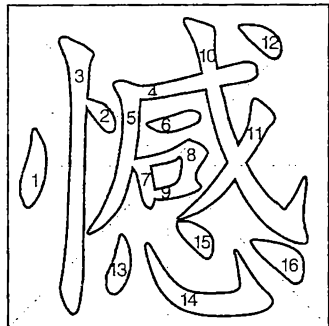

憾 hàn 572

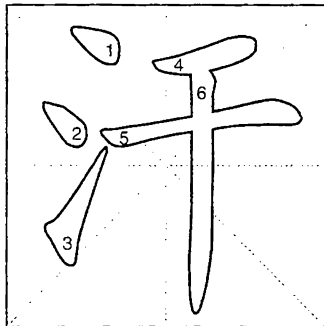

汗 hàn 573

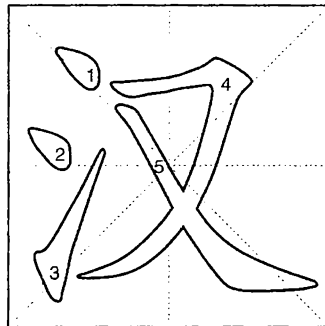

汉 hàn 574

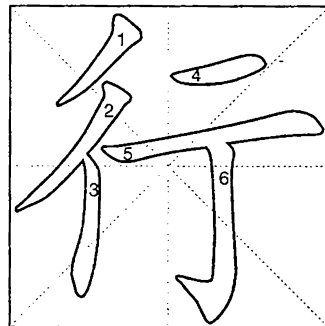

行 háng 575

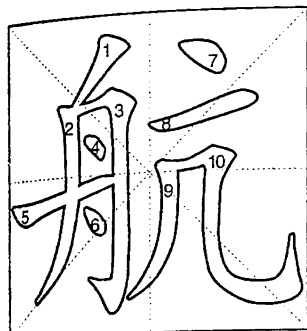

航 háng 576

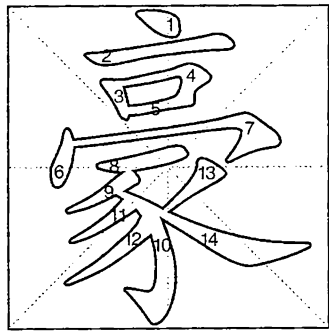

豪 háo 577

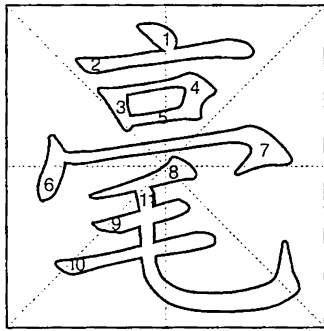

毫 háo 578

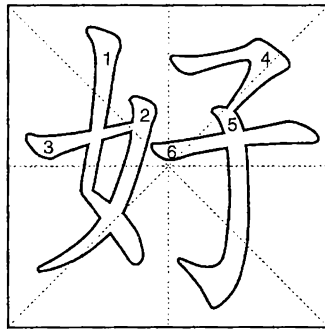

好 hǎo 579

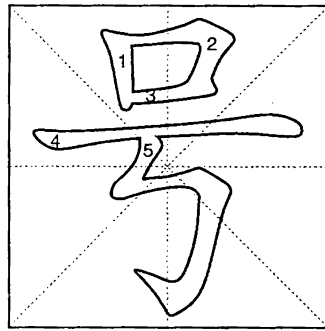

号 hào 580

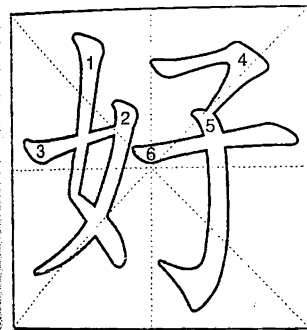

好 hào 581

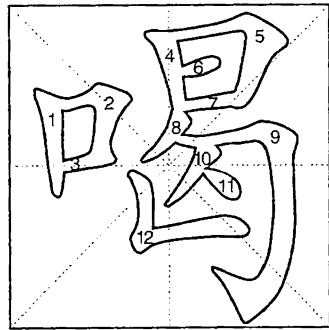

喝 hē 582

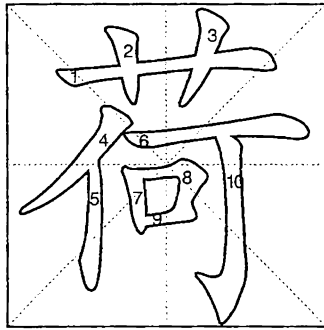

荷 hé 583

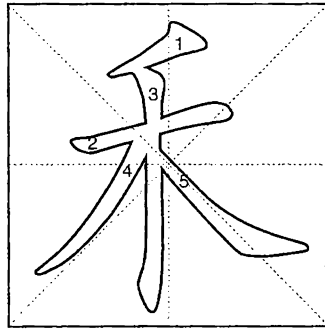

禾 hé 584

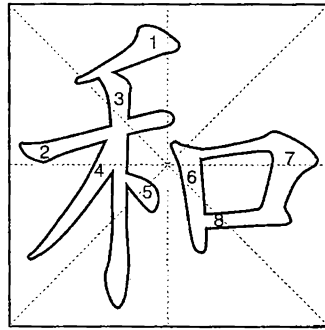

和 hé 585

## 行 háng

① line; row ② seniority among brothers and sisters ③ trade; profession; line of business ④ business firm  
 行当 háng'dàng  
 trade; profession  
 行情 háng'qíng  
 quotations  
 行长 háng'zhǎng  
 president (of a bank)

## 汉 hàn

① the Han nationality ② Chinese's (language) ③ man  
 汉堡包 hàn'bǎo'bāo  
 hamburger  
 汉语 hàn'yǔ  
 Chinese (language)  
 汉字 hàn'zì  
 Chinese character

## 汗 hàn

sweat; perspiration  
 汗衫 hàn'shān  
 undershirt; T-shirt  
 汗珠子 hàn'zhū'zi  
 beads of sweat  
 汗渍 hàn'zì  
 sweat stain

## 憾 hàn

regret  
 憾事 hàn'shì  
 a matter for regret

## 旱 hàn

① dry spell; drought ② dryland  
 ③ on land  
 旱冰鞋 hàn'bīng'xié  
 roller skates; rollerblade  
 旱季 hàn'jì  
 dry season  
 旱灾 hàn'zāi  
 drought

## 号 hào

① name ② assumed name; alternative name ③ business house ④ mark; signal ⑤ number ⑥ size ⑦ date  
 号码 hào'mǎ  
 number  
 号外 hào'wài  
 extra (of a newspaper)  
 号召 hào'zhào  
 call; appeal

## 好 hǎo

① good; fine; nice ② friendly; kind ③ be in good health; get well ④ O.K.; all right; well ⑤ be easy (to do)  
 好久 hǎo'jiǔ  
 for a long time  
 好心 hǎo'xīn  
 good intention  
 好运 hǎo'yùn  
 luck

## 毫 háo

① fine long hair ② writing brush ③ in the least; at all  
 毫不动摇 háo'bù'dòng'yáo  
 firmly  
 毫米 háo'mǐ  
 millimeter(mm.)  
 毫无道理 háo'wú'dào'lǐ  
 utterly unjustifiable

## 豪 háo

① bold and unconstrained; forthright ② despotic  
 豪华 háo'huá  
 luxurious; sumptuous  
 豪门 háo'mén  
 rich and powerful family  
 豪宅 háo'zhái  
 luxury house

## 航 háng

① boat; ship ② navigate (by water or air)  
 航班 háng'bān  
 scheduled flight  
 航线 háng'xiàn  
 route; course  
 航运 háng'yùn  
 shipping

## 和 hé

① gentle; mild; kind ② harmonious; on good terms ③ peace ④ draw; tie ⑤ together with ⑥ with; as ⑦ and  
 和尚 hé'shàng  
 Buddhist monk  
 和谈 hé'tán  
 peace talks  
 和约 hé'yue  
 peace treaty

## 禾 hé

standing grain (esp. rice)  
 禾苗 hé'miáo  
 seedlings of cereal crops

## 荷 hé

lotus  
 荷包蛋 hé'bāo'dàn  
 fried eggs  
 荷花 hé'huā  
 lotus  
 荷兰豆 hé'lán'dòu  
 snow pea

## 喝 hē

① drink ② drink alcoholic liquor  
 喝汤 hē'tāng  
 eat soup  
 喝西北风, hē'xī'běi'fēng  
 have nothing to eat  
 喝醉 hē'zuì  
 get drunk

## 好 hào

① like; love; be fond of ② be liable to  
 好客 hào'kè  
 be hospitable  
 好奇心 hào'qí'xīn  
 curiosity  
 好学 hào'xué  
 be eager to learn

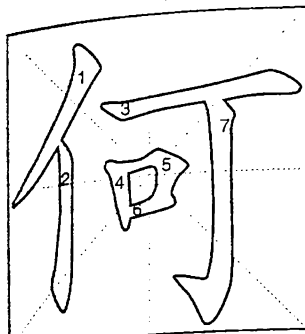

何 hé

586

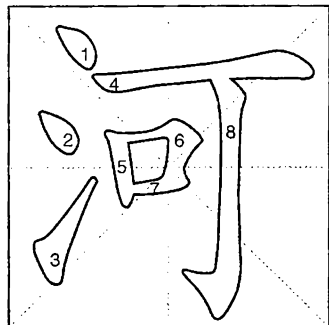

河 hé

587

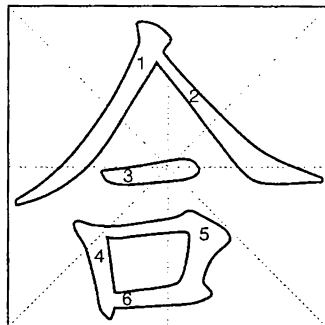

合 hé

588

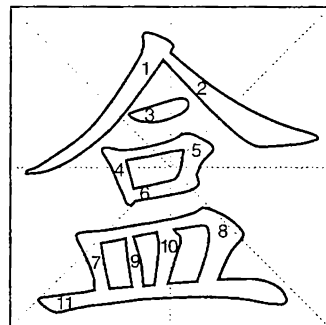

盒 hé

589

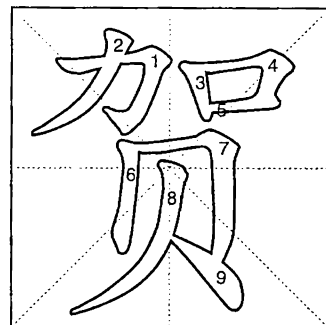

贺 hè

590

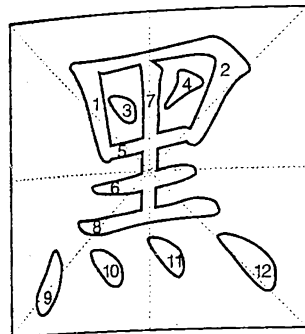

黑 hēi

591

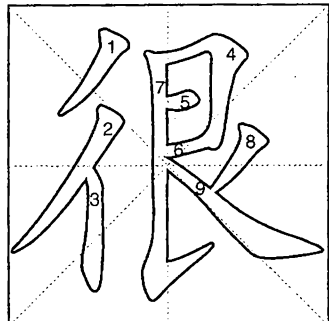

很 hěn

592

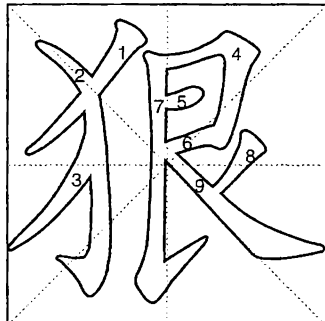

狠 hěn

593

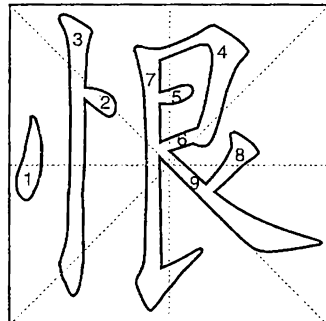

恨 hèn

594

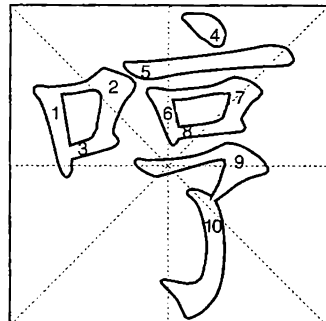

亨 hēng

595

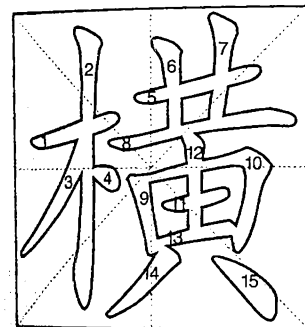

横 héng

596

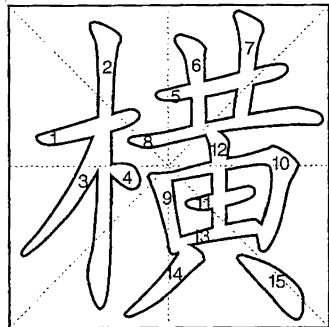

横 hèng

597

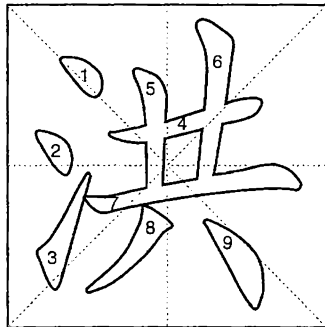

洪 hóng

598

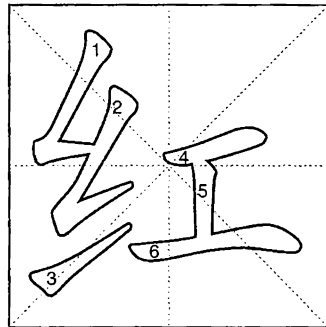

红 hóng

599

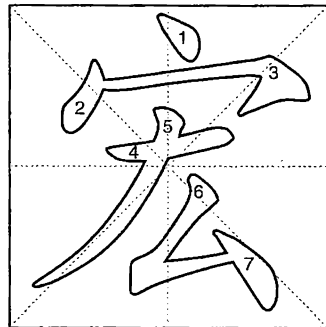

宏 hóng

600

**贺 hè**

congratulate  
 贺电 hè'diàn  
 congratulatory telegram  
 贺卡 hè'kǎ  
 card  
 贺礼 hè'lǐ  
 gift

**盒 hé**

box; case  
 盒带 hé'dài  
 cassette tape; cassette  
 盒饭 hé'fàn  
 packed lunch; box lunch  
 盒子 hé'zi  
 box; case; casket

**合 hé**

① close; shut ② join; combine  
 ③ whole (family) ④ suit; agree (with)  
 ⑤ be equal to; add up to  
 合格 hé'gé  
 qualified  
 合同 hé'tóng  
 contract  
 合资企业 hé'zī'qǐ'yè  
 joint venture

**河 hé**

river  
 河流 hé'liú  
 rivers  
 河网 hé'wǎng  
 a network of waterways  
 河鱼 hé'yú  
 river fish

**何 hé**

何不 hé'bù  
 why-not  
 何苦 hé'kǔ  
 why bother  
 何以 hé'yǐ  
 how; why

**哼 hēng**

① groan; snort ② hum; croon  
 哼哧 hēng'chī  
 puff hard  
 哼哼哈哈 hēng'hēng'hā'hā  
 hem and ham

**恨 hèn**

① hate ② regret

**狠 hěn**

① ruthless; relentless  
 ② suppress (one's feelings); harden  
 (the heart)  
 ③ firm; resolute  
 狠毒 hěn'dú  
 vicious  
 狠心 hěn'xīn  
 cruel-hearted; heartless

**很 hěn**

very; quite; awfully

**黑 hēi**

① black ② dark ③ secret; shady  
 ④ wicked; sinister  
 黑暗 hēi'àn  
 dark  
 黑板 hēi'bǎn  
 blackboard  
 黑豆 hēi'dòu  
 black soya bean

**宏 hóng**

great; grand; magnificent  
 宏大 hóng'dà  
 grand; great  
 宏图 hóng'tú  
 great plan  
 宏伟 hóng'wěi  
 magnificent; grand

**红 hóng**

① red ② revolutionary  
 红宝石 hóng'bǎo'shí  
 ruby  
 红茶 hóng'chá  
 black tea  
 红豆 hóng'dòu  
 red bean

**洪 hóng**

① big; vast ② flood  
 洪峰 hóng'fēng  
 flood peak  
 洪亮 hóng'liàng  
 loud and clear  
 洪水 hóng'shuǐ  
 flood; floodwater

**横 hèng**

① harsh and unreasonable; per-  
 verse 发~ act in a brutal way  
 ② unexpected  
 横财 hèng'cái  
 ill-gotten wealth  
 横祸 hèng'huò  
 unexpected calamity  
 横死 hèng'sǐ  
 meet with a sudden death

**横 héng**

① horizontal; transverse ② across;  
 sideways ③ move crosswise; tra-  
 verse ④ unrestrainedly; turbulently  
 横笛 héng'dí  
 flute  
 横渡 héng'dù  
 cross (a river; etc.)  
 横扫 héng'sǎo  
 sweep away

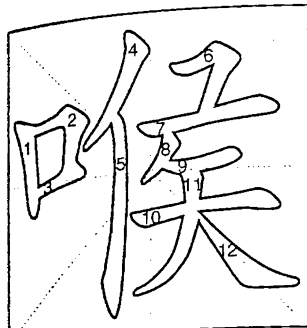

喉 hóu

601



猴 hóu

602

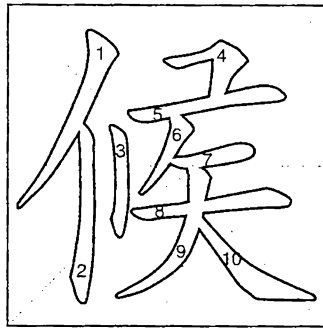

候 hòu

603

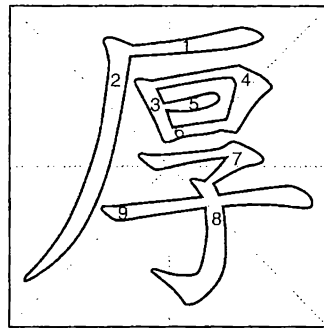

厚 hòu

604

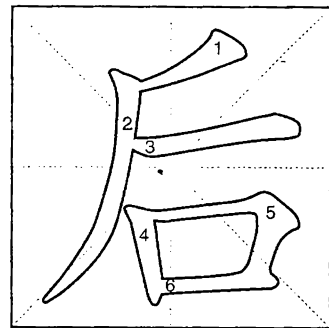

后 hòu

605

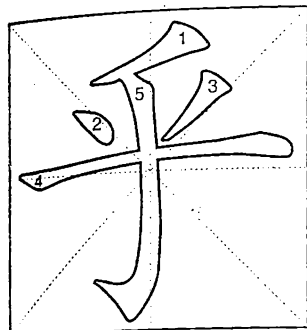

乎 hū

606



呼 hū

607

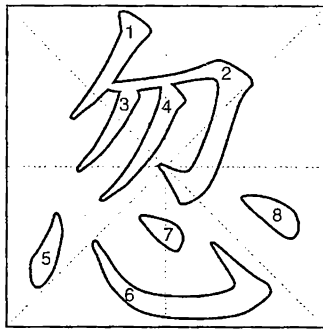

忽 hū

608

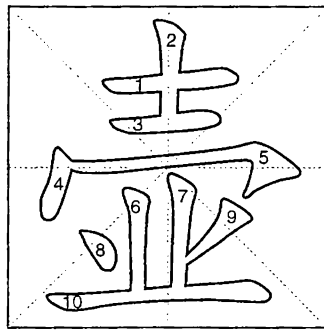

壶 hú

609

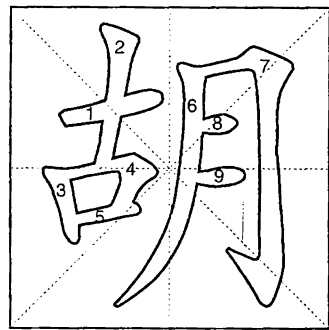

胡 hú

610

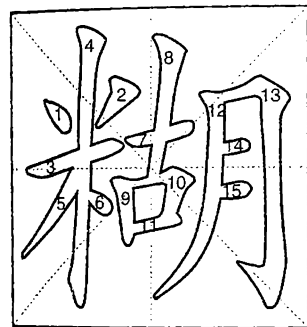

糊 hú

611

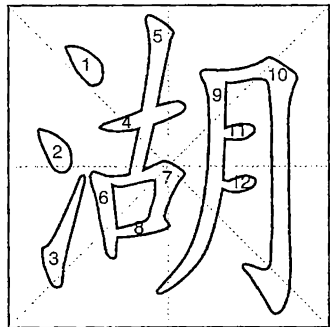

湖 hú

612

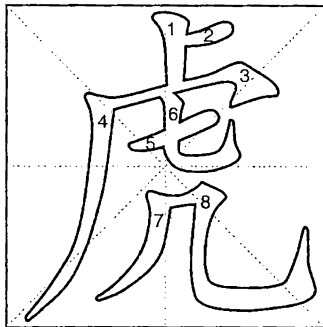

虎 hǔ

613

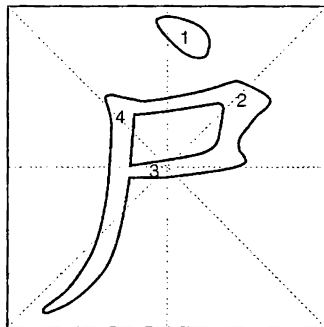

户 hù

614

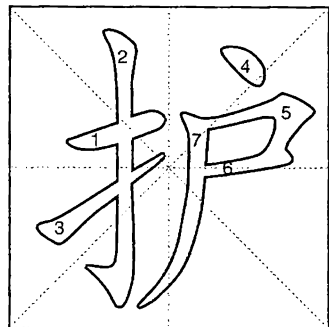

护 hù

615

### 后 hòu

①behind; back; rear ②after; afterwards; later ③offspring ④empress; queen  
 后方 hòu'fāng  
 rear  
 后跟 hòu'gēn  
 heel  
 后门 hòu'mén  
 back door

### 厚 hòu

①thick ②deep; profound  
 ③ kind; magnanimous ④ large; generous ⑤rich or strong in flavour  
 ⑥favour; stress  
 厚爱 hòu'ài  
 your kindness  
 厚度 hòu'dù  
 thickness  
 厚礼 hòu'lǐ  
 generous gift

### 候 hòu

①wait; await ②inquire after  
 候车 hòu'chē  
 waiting for a train or bus  
 候机室 hòu'jī'shì  
 airport lounge  
 候鸟 hòu'niǎo  
 migratory bird; migrant

### 猴 hóu

①monkey ②clever boy  
 猴皮筋 hóu'pí'jīn  
 rubber band  
 猴戏 hóu'xì  
 monkey show  
 猴子 hóu'zi  
 monkey

### 喉 hóu

larynx; throat  
 喉咙 hóu'lóng  
 throat  
 喉舌 hóu'shé  
 mouthpiece  
 喉头 hóu'tóu  
 larynx; throat

### 胡 hú

①introduced from the northern and western nationalities or from abroad  
 ②recklessly; wantonly; outrageously  
 ③moustache, beard or whiskers  
 胡椒 hú'jiāo  
 pepper  
 胡萝卜 hú'luó'bo  
 carrot  
 胡须 hú'xū  
 beard

### 壶 hú

①kettle; pot ②bottle; flask

### 忽 hū

①neglect; overlook; ignore  
 ②suddenly

### 呼 hū

①breathe out; exhale ②shout; cry out ③call  
 呼叫 hū'jiào  
 call out; shout; call  
 呼吸 hū'xī  
 breathe; respiration  
 呼吁 hū'yù  
 appeal; call on

### 乎 hū

超乎寻常 chāo'hū'xún'cháng  
 be out of the ordinary  
 天乎 tiān'hū  
 Oh, my God!

### 护 hù

①protect; guard; shield ②be partial to; shield from censure  
 护士 hù'shì  
 nurse  
 护送 hù'sòng  
 convoy  
 护照 hù'zhào  
 passport

### 户 hù

①door ②(bank)account  
 户头 hù'tóu  
 (bank)account  
 户外 hù'wài  
 outdoor  
 户主 hù'zhǔ  
 head of a household

### 虎 hǔ

①tiger ②brave; vigorous  
 虎口余生 hǔ'kǒu'yú'shēng  
 survive a disaster  
 虎啸 hǔ'xiào  
 roars of tiger  
 虎穴 hǔ'xué  
 tiger's den

### 湖 hú

lake  
 湖光山色 hú'guāng'shān'sè  
 a landscape of lakes and mountains

### 糊 hú

①paste ②stick with paste  
 ③(of food) burnt  
 糊口 hú'kǒu  
 keep body and soul together  
 糊涂 hú'tu  
 muddled; confused  
 糊涂观念 hú'tu'guān'niàn  
 muddled idea

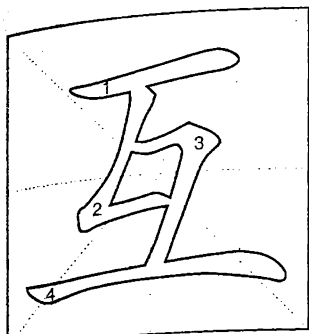

互 hù 616

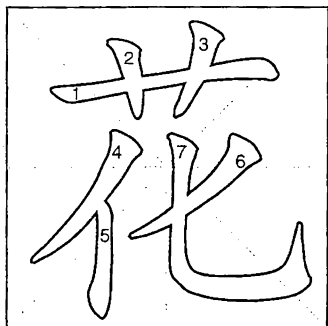

花 huā 617

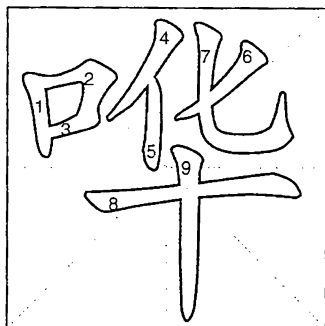

哗 huā 618

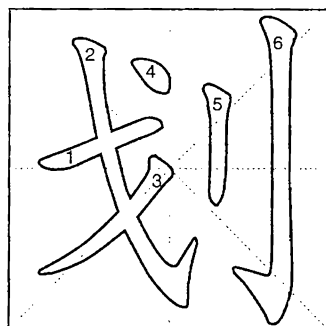

划 huá 619

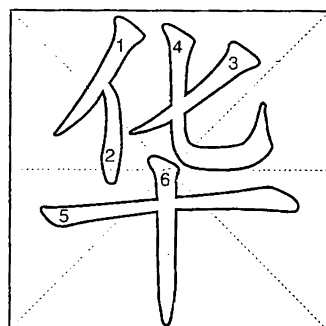

华 huá 620

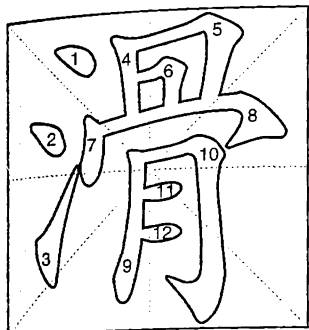

滑 huá 621

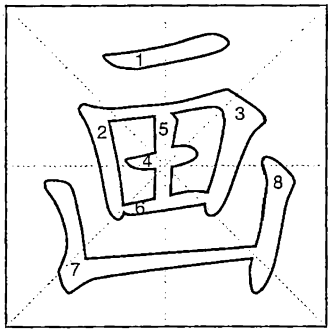

画 huà 622

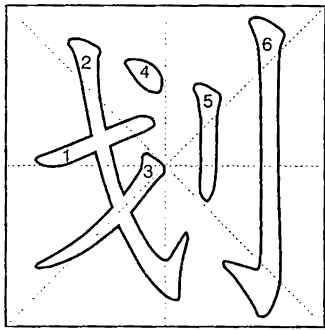

划 huà 623

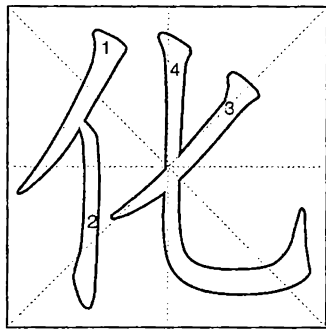

化 huà 624

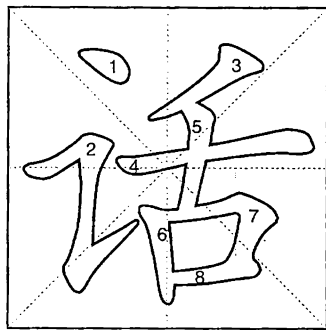

话 huà 625

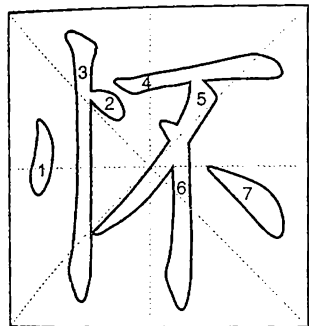

怀 huái 626

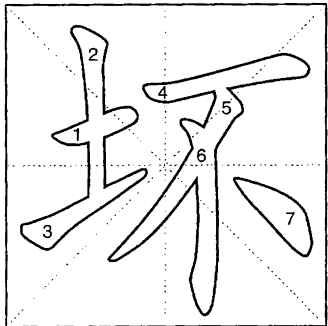

坏 huài 627

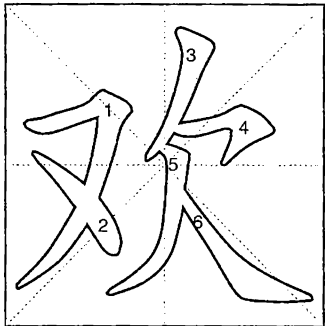

欢 huān 628

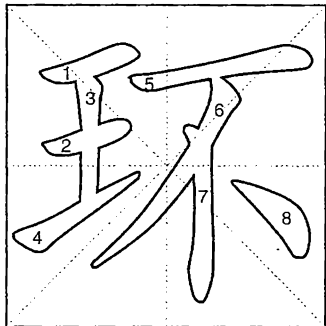

环 huán 629

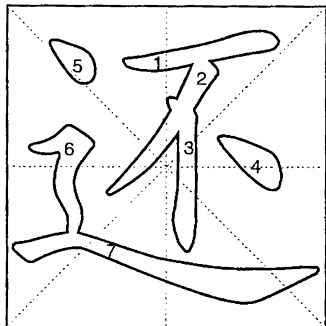

还 huán 630



### 华 huá

① magnificent; splendid ② prosperous; flourishing ③ best part ④ flashy; extravagant; luxurious  
 华尔兹 huá'ěr'zī  
 waltz  
 华丽 huá'li  
 magnificent  
 华人 huá'rén  
 Chinese

### 划 huá

① paddle; row (a boat) ② be to one's profit; pay ③ scratch; cut the surface of  
 划拳 huá'quán  
 finger-guessing game  
 划艇 huá'tǐng  
 rowboat; canoe  
 划子 huá'zi  
 small rowboat

### 哗 huā

哗啦 huā'lā  
 clatter

### 花 huā

① flower; blossom; bloom ② pattern; design ③ coloured; variegated ④ blurred; dim ⑤ spend; expend  
 花草 huā'cǎo  
 flowers and plants  
 花店 huā'diàn  
 florist shop  
 花生 huā'shēng  
 peanut; groundnut

### 互 hù

mutual; each other  
 互访 hù'fǎng  
 exchange visits  
 互利 hù'lì  
 mutually beneficial  
 互联网 hù'lián'wǎng  
 Internet

### 话 huà

① word; talk ② talk about; speak about  
 话别 huà'bié  
 say good-bye  
 话费 huà'fèi  
 telephone bill  
 话网 huà'wǎng  
 telephone network

### 化 huà

① change; turn; transform ② convert; influence ③ melt; dissolve; (of snow, ice) thaw ④ digest ⑤ burn up ⑥ chemistry  
 化肥 huà'féi  
 chemical fertilizer  
 化工 huà'gōng  
 chemical industry  
 化石 huà'shí  
 fossil

### 划 huà

① delimit; differentiate ② transfer; assign ③ draw; mark; delineate  
 划拨 huà'bō  
 appropriate; transfer  
 划分 huà'fēn  
 divide; differentiate  
 划清 huà'qīng  
 make a clear distinction

### 画 huà

① draw; paint ② drawing; painting ③ be decorated with paintings or pictures  
 画报 huà'bào  
 pictorial  
 画笔 huà'bǐ  
 brush  
 画展 huà'zhǎn  
 art exhibition

### 滑 huá

① slippery; smooth ② slip; slide ③ cunning; crafty; slippery  
 滑板 huá'bǎn  
 skateboarding  
 滑冰 huá'bīng  
 ice-skating  
 滑水 huá'shuǐ  
 water skiing

### 还 huán

① go back ② give back; return; repay ③ give or do sth. in return  
 还清 huán'qīng  
 pay off  
 还原 huán'yuan  
 restore  
 还账 huán'zhàng  
 pay bills

### 环 huán

① ring; hoop ② link ③ surround; encircle; hem in  
 环保 huán'bǎo  
 environmental protection  
 环境 huán'jìng  
 environment  
 环球 huán'qiú  
 round the world

### 欢 huān

① joyous; merry; jubilant ② vigorously; with great drive; in full swing  
 欢庆 huān'qīng  
 celebrate joyously  
 欢送 huān'sòng  
 see off; send off  
 欢迎 huān'yíng  
 welcome; greet

### 坏 huài

① bad ② go bad; spoil; ruin ③ badly; awfully; very ④ evil idea  
 坏处 huài'chù  
 harm; disadvantage  
 坏人 huài'rén  
 bad person; evildoer  
 坏账 huài'zhàng  
 a bad debt

### 怀 huái

① bosom ② mind ③ keep in mind; cherish ④ think of; yearn for ⑤ conceive (a child)  
 怀表 huái'biǎo  
 pocket watch  
 怀疑 huái'yí  
 distrust; doubt; suspect  
 怀孕 huái'yùn  
 be pregnant



缓 huǎn 631



换 huàn 632

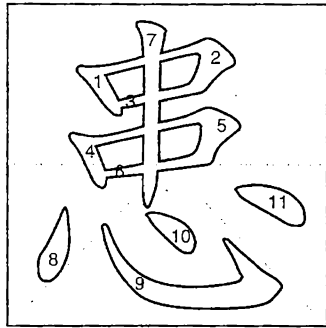

患 huàn 633

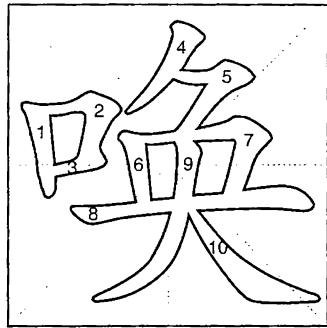

唤 huàn 634

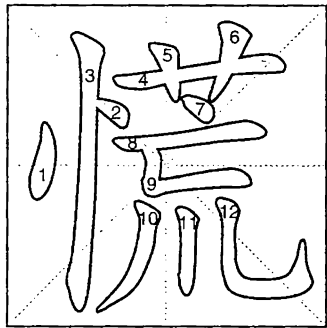

慌 huāng 635

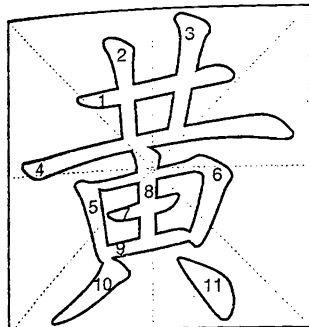

黄 huáng 636

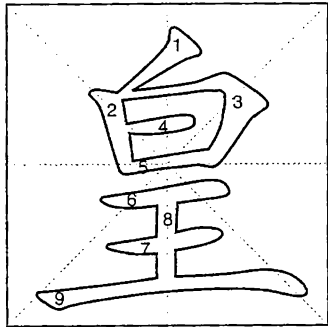

皇 huáng 637

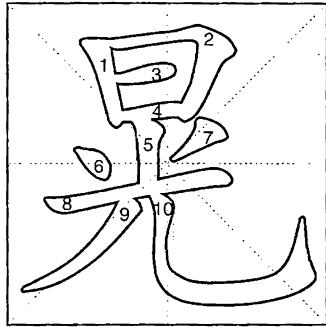

晃 huǎng 638

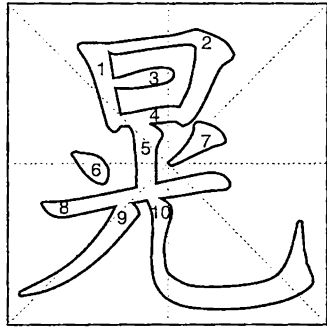

晃 huàng 639

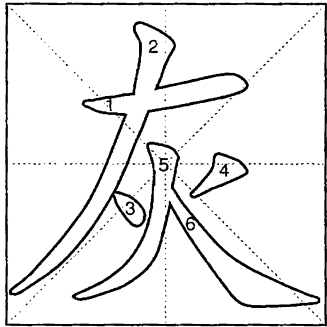

灰 huī 640

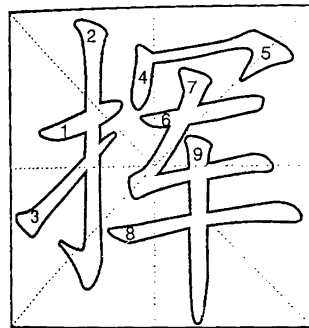

挥 huī 641



辉 huī 642

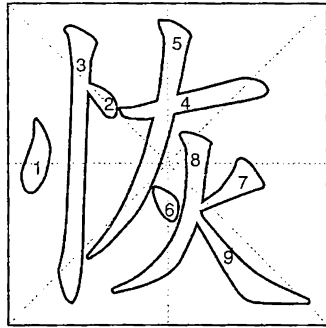

恢 huī 643

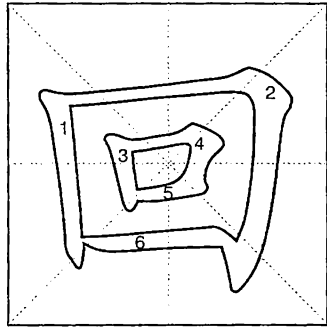

回 huí 644

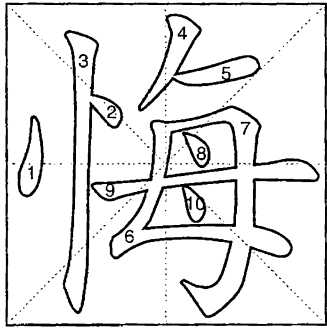

悔 huǐ 645

**慌 huāng**

flurried; flustered  
 慌里慌张 huāng'li'huāng'zhāng  
 lose one's head  
 慌乱 huāng'luàn  
 in a hurry; in a rush  
 慌张 huāng'zhāng  
 confused; flustered

**唤 huàn**

call out  
 唤起 huàn'qǐ  
 arouse; call; recall  
 唤醒 huàn'xǐng  
 wake up; awaken

**患 huàn**

①trouble; peril disaster  
 ②anxiety; worry ③contract  
 患病 huàn'bìng  
 suffer from an illness  
 患处 huàn'chù  
 affected part  
 患者 huàn'zhě  
 sufferer; patient

**换 huàn**

①exchange; barter; trade ②change  
 换车 huàn'chē  
 change trains or buses  
 换挡 huàn'dǎng  
 shift gears  
 换汇 huàn'huì  
 gain foreign exchange

**缓 huǎn**

① slow; unhurried ② delay;  
 postpone; put off ③ not tense; re-  
 laxed  
 缓和 huǎn'hé  
 relax; ease up; calm down  
 缓慢 huǎn'màn  
 slow  
 缓刑 huǎn'xíng  
 reprieve; probation

**灰 huī**

①ash ②dust ③lime; mortar  
 ④grey ⑤discouraged  
 灰尘 huī'chén  
 dust; dirt  
 灰姑娘 huī'gū'niang  
 Cinderella  
 灰心 huī'xīn  
 lost heart

**晃 huàng**

shake; sway  
 晃荡 huàng'dang  
 rock; shake; sway  
 晃动 huàng'dòng  
 rock; sway  
 晃悠 huàng'yōu  
 wobble; stagger

**晃 huǎng**

①dazzle ②flash past  
 晃眼 huǎng'yǎn  
 dazzle

**皇 huáng**

emperor; sovereign  
 皇帝 huáng'dì  
 emperor  
 皇宫 huáng'gōng  
 (imperial)palace  
 皇冠 huáng'guān  
 imperial crown

**黄 huáng**

yellow; sallow  
 黄豆 huáng'dòu  
 soya bean; soybean  
 黄瓜 huáng'guā  
 cucumber  
 黄金 huáng'jīn  
 gold

**悔 huǐ**

regret; repent  
 悔过 huǐ'guò  
 repent one's error  
 悔恨 huǐ'hèn  
 regret deeply  
 悔悟 huǐ'wù  
 realize one's error and show re-  
 pentance

**回 huí**

①circle; wind ②return; go back  
 ③turn ④answer; reply  
 回程 huí'chéng  
 return trip  
 回家 huí'jiā  
 return home  
 回声 huí'shēng  
 echo

**恢 huī**

extensive; vast  
 恢复 huī'fù  
 resume; renew; regain

**辉 huī**

①brightness; splendour ②shine  
 辉煌 huī'huáng  
 brilliant; glorious

**挥 huī**

①wave; wield ②wipe off  
 ③command (an army) ④scatter  
 挥动 huī'dòng  
 wave; brandish  
 挥金如土 huī'jīn'rú'tǔ  
 spend money like dirt  
 挥手 huī'shǒu  
 wave one's hand; wave

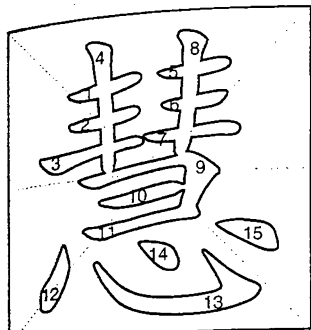

慧 huì 646

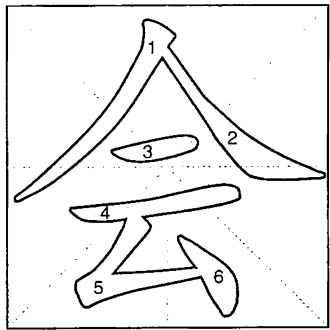

会 huì 647

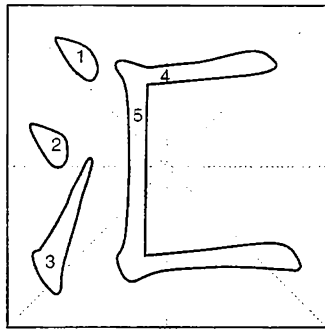

汇 huì 648

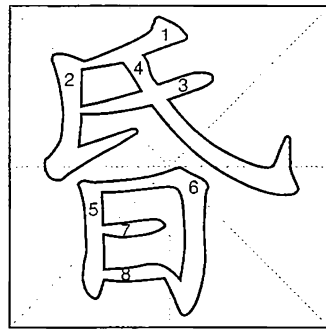

昏 hūn 649

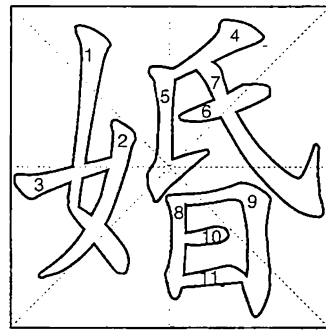

婚 hūn 650

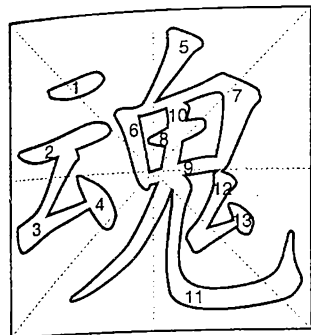

魂 hún 651

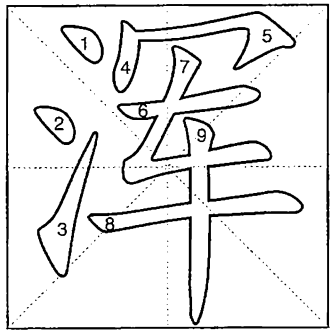

浑 hún 652

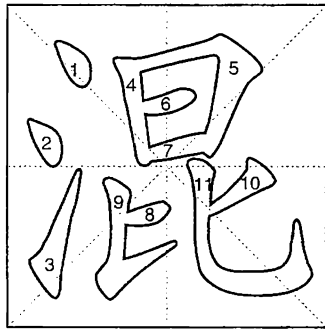

混 hùn 653

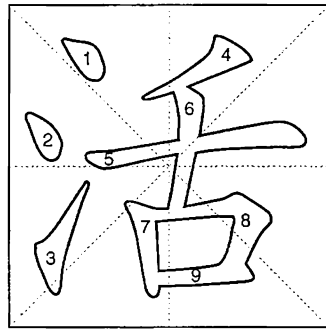

活 huó 654

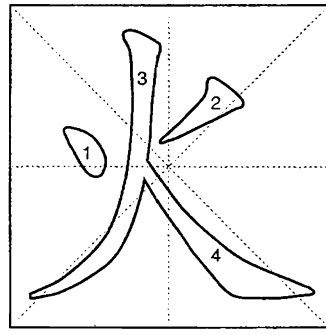

火 huǒ 655

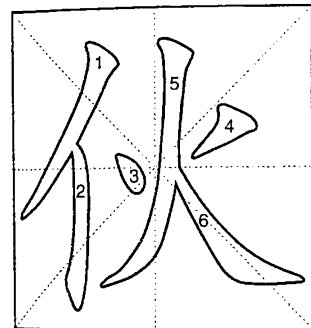

伙 huǒ 656

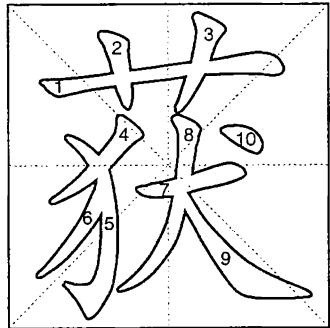

获 huò 657

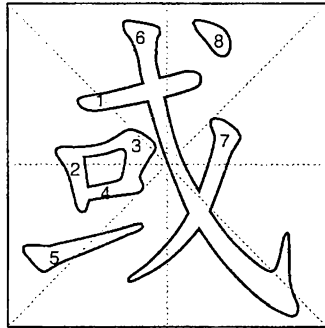

或 huò 658

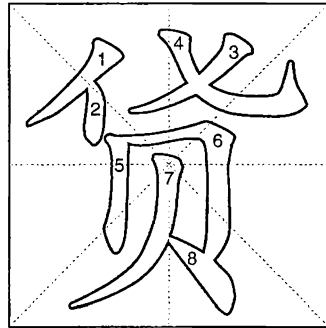

货 huò 659

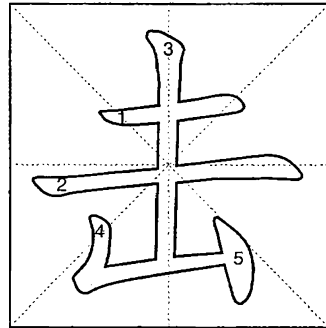

击 jī 660

### 婚 hūn

- ①wed; marry  
 ②marriage; wedding  
 婚嫁 hūn'jià  
 marriage  
 婚礼 hūn'li  
 wedding ceremony  
 婚期 hūn'qī  
 wedding day

### 昏 hūn

- ①dusk ②dark; dim ③confused;  
 muddled ④lose consciousness; faint  
 昏暗 hūn'àn  
 dim; dusky  
 昏迷 hūn'mí  
 coma  
 昏睡 hūn'shуй  
 lethargic sleep; lethargy

### 汇 huì

- ①converge ②gather together  
 ③ things collected; assemblage;  
 collection ④remit (money)  
 汇报 huì'bào  
 report; give an account of  
 汇率 huì'lǜ  
 exchange rate  
 汇演 huì'yǎn  
 joint performance

### 会 huì

- ①get together; assemble ②see  
 ③ meeting; gathering; party ④as-  
 sociation; society; union ⑤can; be  
 able to  
 会见 huì'jiàn  
 meet with  
 会客 huì'kè  
 receive a visitor(or guest)  
 会签 huì'qiān  
 countersign

### 慧 huì

- intelligent; bright  
 慧眼 huì'yǎn  
 insight; acumen

### 火 huǒ

- ① fire ② firearms; ammunition  
 ③fiery; flaming ④anger; temper  
 火柴 huǒ'chái  
 match  
 火车 huǒ'chē  
 train  
 火化 huǒ'huà  
 cremation

### 活 huó

- ① live ② alive; living ③ save  
 (the life of a person) ④vivid; lively  
 ⑤movable; moving ⑥exactly; sim-  
 ply ⑦work ⑧product  
 活力 huó'lì  
 vigour; vitality; energy  
 活泼 huó'pō  
 lively; vivacious; vivid  
 活水 huó'shuǐ  
 flowing water

### 混 hùn

- ①mix; confuse ②pass for; pass  
 off as ③muddle along ④get a-  
 long with sb. ⑤thoughtlessly; reck-  
 lessly  
 混沌 hùn'dùn  
 Chaos; innocent  
 混合 hùn'hé  
 mix  
 混凝土 hùn'níng'tǔ  
 concrete

### 浑 hún

- ①muddy; turbid ②foolish; stupid  
 ③simple and natural ④whole; all over  
 浑身 hún'shēn  
 from head to foot; all over  
 浑水摸鱼 hún'shuǐ'mō'yú  
 fish in troubled waters  
 浑浊 hún'zhuó  
 muddy; turbid

### 魂 hún

- ①soul ②mood; spirit  
 魂不附体 hún'bù'tǐ  
 as if the soul had left the body  
 魂灵 hún'líng  
 soul  
 魂魄 hún'pò  
 soul

### 击 jī

- ①beat; hit; strike ②attack; as-  
 sault ③come in contact with; bump  
 into  
 击败 jī'bài  
 defeat; beat; vanquish  
 击剑<体> jī'jiàn<tǐ>  
 fencing  
 击中 jī'zhòng  
 hit

### 货 huò

- ①goods; commodity  
 ②money; currency  
 货币 huò'bì  
 money; currency  
 货款 huò'kuǎn  
 payment for goods  
 货物 huò'wù  
 goods; commodity

### 或 huò

- ①perhaps; maybe; probably  
 ②or; either...or...  
 或大或小 huò'dà'huò'xiǎo  
 either large or small  
 或去或留 huò'qù'huò'liú  
 go or stay  
 或许 huò'xǔ  
 perhaps; maybe

### 获 huò

- ①capture; catch ②obtain; win  
 获得 huò'dé  
 gain; obtain; acquire  
 获奖 huò'jiǎng  
 win a prize  
 获准 huò'zhǔn  
 have permission

### 伙 huǒ

- ①mess; board; meals ②partner;  
 mate ③partnership; company  
 ④group; crowd; band  
 ⑤combine; join  
 伙伴 huǒ'bàn  
 partner; companion  
 伙房 huǒ'fáng  
 kitchen  
 伙计 huǒ'jì  
 partner; fellow; mate

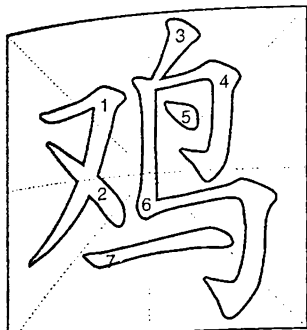

鸡 jī

661

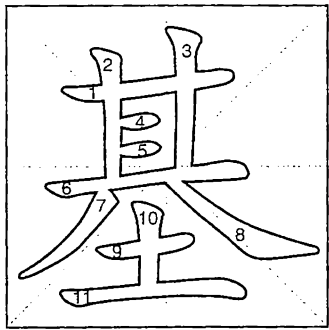

基 jī

662

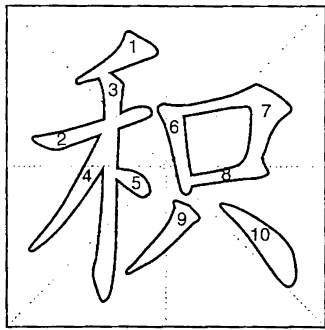

积 jī

663

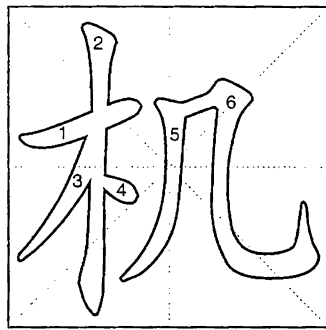

机 jī

664

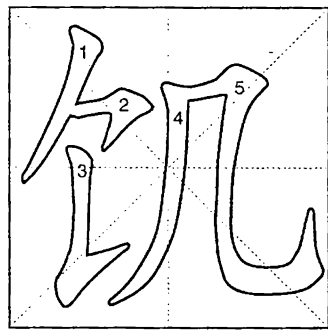

饥 jī

665

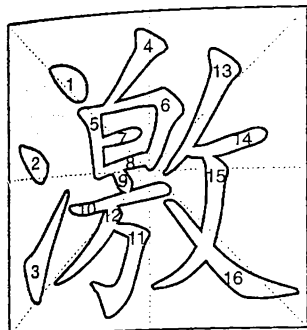

激 jī

666

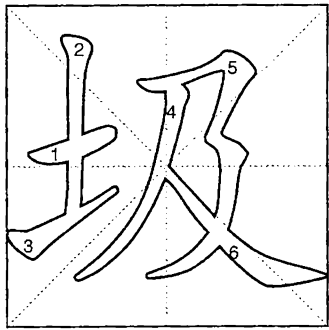

圾 jī

667

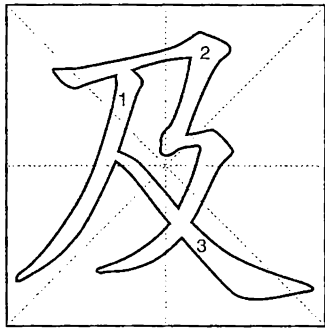

及 jí

668

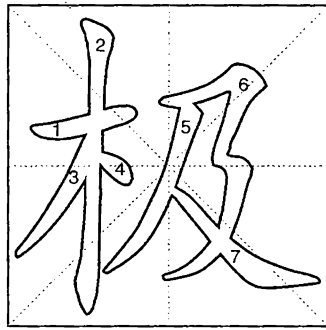

极 jí

669

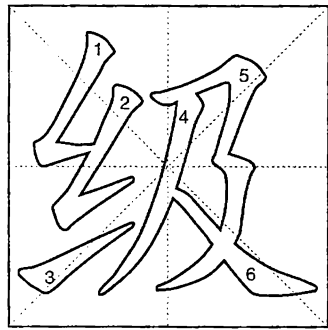

级 jí

670

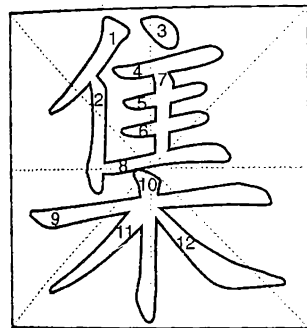

集 jí

671

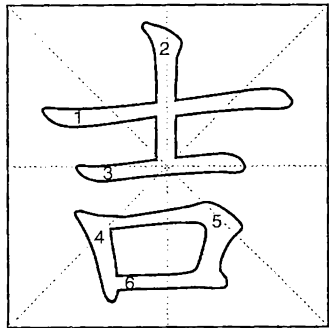

吉 jí

672



急 jí

673

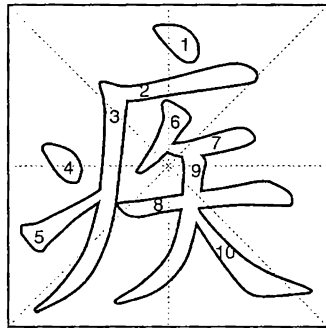

疾 jí

674

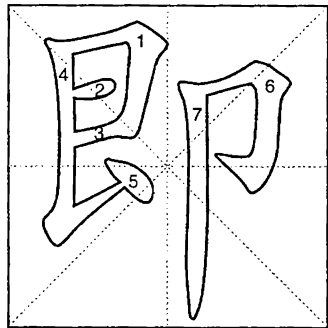

即 jí

675

### 饥 jī

① be hungry; starve; famish  
 ② famine  
 饥饿 jī'è  
 hunger; starvation  
 饥荒 jī'huāng  
 famine; crop failure  
 饥民 jī'mín  
 famine victim

### 机 jī

① machine; engine ② aircraft; aeroplane ③ crucial point; pivot; key link ④ chance; occasion  
 机场 jī'chǎng  
 airport; airfield  
 机床 jī'chuáng  
 machine tool  
 机会 jī'huì  
 chance; opportunity

### 积 jī

① amass; store up; accumulate  
 ② long-standing; longpending; age-old  
 积习 jī'xí  
 old habit  
 积雪 jī'xuě  
 accumulated snow  
 积压 jī'yā  
 overstock

### 基 jī

① base; foundation ② basic; key; primary; cardinal ③ radical; base; group  
 基本 jī'běn  
 essential; key; basic; fundamental  
 基地 jī'dì  
 base  
 基督 jī'dū  
 Christ ~ 教 Christianity ~ 徒 Christian

### 鸡 jī

chicken  
 鸡蛋 jī'dàn  
 egg  
 鸡毛 jī'máo  
 chicken feather  
 鸡肉 jī'ròu  
 chicken

### 级 jì

① level; rank; grade ② grade; class; form ③ step ④ degree  
 级别 jī'bié  
 rank; level; grade; scale  
 级差 jī'chā  
 differential; graded

### 极 jí

① the utmost point; extremity ② pole ③ extremely; exceedingly  
 极品 jí'pǐn  
 highest grade  
 极限 jí'xiàn  
 the limit; the maximum  
 极刑 jí'xíng  
 capital punishment

### 及 jí

① reach; come up to ② in time for ③ and  
 及格 jí'gé  
 pass a test 不~fail  
 及时 jí'shí  
 timely; promptly  
 及早 jí'zǎo  
 as soon as possible

### 圾 jī

垃圾 lā'jī  
 rubbish; garbage; refuse

### 激 jī

① swash; surge; dash ② stimulate; excite ③ sharp; fierce; violent  
 激动 jī'dòng  
 stir; heat; excite; agitate  
 激发 jī'fā  
 arouse; set off; stir up  
 激光〈物〉 jī'guāng〈wù〉  
 laser

### 即 jí

① approach; reach; be near ② assume; undertake ③ at present; in the immediate future  
 即将 jí'jiāng  
 be about to  
 即使 jí'shǐ  
 even; even though  
 即兴表演 jí'xìng'biǎo'yǎn  
 improvisation

### 疾 jí

① disease; sickness; illness ② suffering; pain; difficulty ③ hate; abhor ④ fast; quick  
 疾病 jí'bìng  
 disease; illness  
 疾苦 jí'kǔ  
 sufferings; hardships  
 疾驶 jí'shǐ  
 speed

### 急 jí

① impatient; anxious ② worry ③ irritated; annoyed ④ fast; rapid; violent ⑤ urgent; pressing  
 急电 jí'diàn  
 urgent telegram  
 急救 jí'jiù  
 emergency treatment  
 急忙 jí'máng  
 in a hurry; in haste

### 吉 jí

lucky  
 吉卜赛人 jí'bù'sài'rén  
 Gypsy  
 吉利 jí'lì  
 lucky; auspicious  
 吉普车 jí'pǔ'chē  
 jeep

### 集 jí

① gather; collect ② country fair; market ③ collection; anthology ④ volume; part  
 集市 jí'shì  
 country fair; market  
 集团 jí'tuán  
 group; bloc; clique  
 集邮 jí'yóu  
 stamp collecting

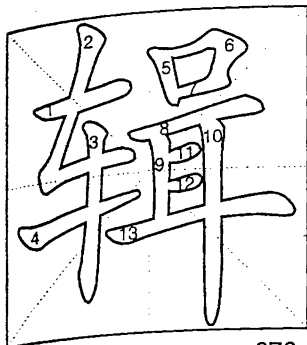

辑 jí

676

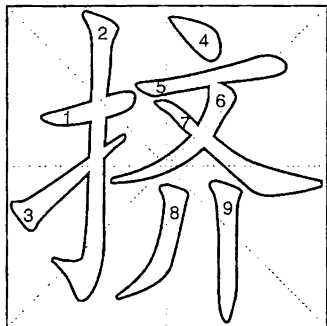

挤 jǐ

677

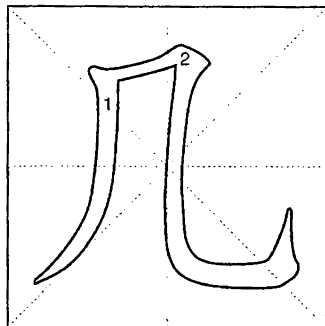

几 jǐ

678

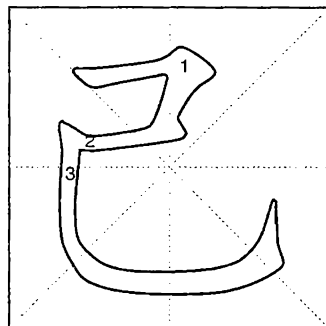

己 jǐ

679

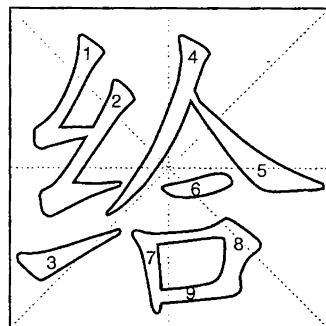

给 jǐ

680

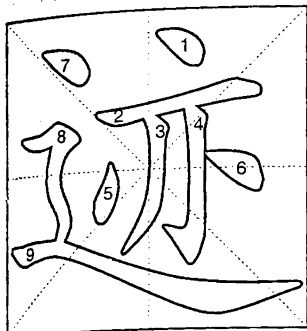

迹 jì

681



绩 jì

682

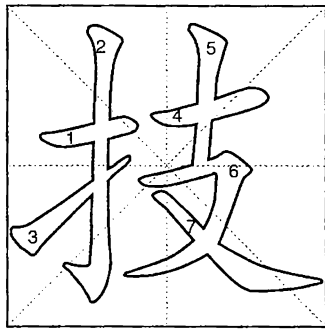

技 jì

683

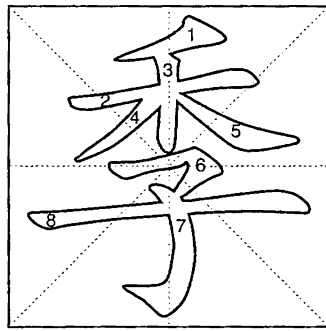

季 jì

684

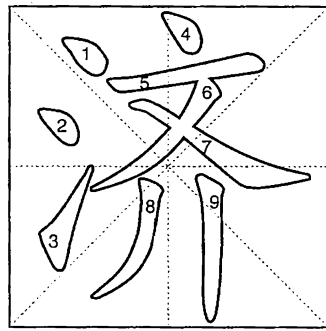

济 jì

685

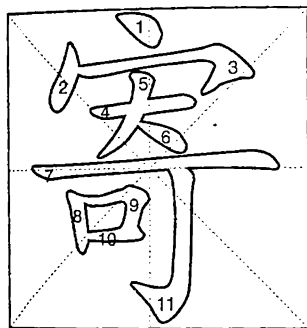

寄 jì

686

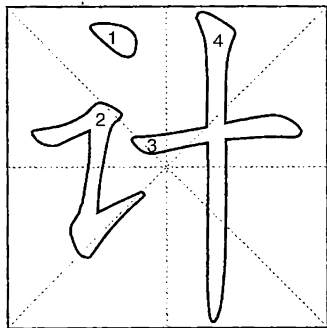

计 jì

687

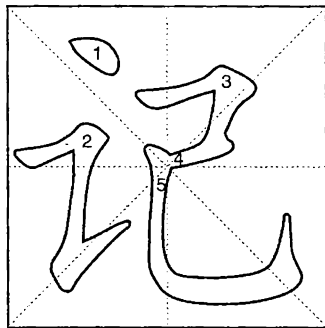

记 jì

688

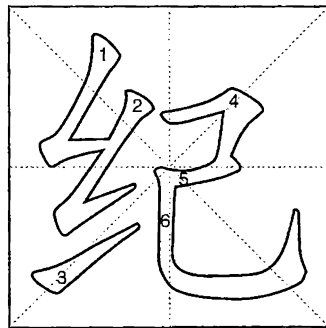

纪 jì

689

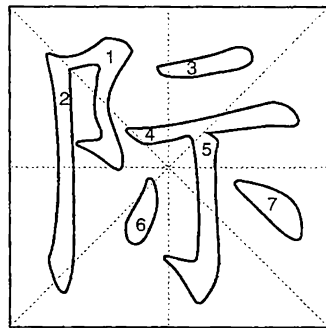

际 jì

690



### 给 jǐ

① supply; provide ② ample; well provided for  
 给水 jǐ shuǐ  
 water supply; feed water  
 给养 jǐ yǎng  
 provisions; rations  
 给予 jǐ yǔ  
 give; render; offer

### 己 jǐ

oneself; one's own; personal  
 己方 jǐ fāng  
 one's own side  
 己见 jǐ jiàn  
 one's own opinion

### 几 jǐ

how many  
 几个 jǐ gè  
 several; some; a few  
 几何学〈数〉 jǐ hé xué 〈shù〉  
 geometry  
 几时 jǐ shí  
 what time; when

### 挤 jǐ

① squeeze; press ② jostle; push against ③ crowd; pack; cram  
 挤车 jǐ chē  
 pack into a bus  
 挤奶 jǐ nǎi  
 draw milk  
 挤时间 jǐ shí jiān  
 find time

### 辑 jí

collect; edit; part; volume  
 辑录 jí lù  
 compile

### 济 jì

① cross a river ② aid; relieve; help ③ be of help  
 济贫 jì pín  
 relieve the poor

### 季 jì

season  
 季度 jì dù  
 quarter (of a year)  
 季节 jì jié  
 season  
 季刊 jì kān  
 quarterly publication

### 技 jì

skill; ability; trick  
 技工 jì gōng  
 skilled worker  
 技巧 jì qiǎo  
 skill; technique  
 技术 jì shù  
 techniques; skill

### 绩 jì

① twist hempen thread ② accomplishment; merit  
 绩优股 jì yōu gǔ  
 blue chip stock or share

### 迹 jì

mark; trace; remains; vestige; an outward sign  
 迹象 jì xiàng  
 sign; indication

### 际 jì

① border; boundary; edge  
 ② between; among; inter ③ inside  
 ④ occasion; time ⑤ one's lot; circumstances  
 际遇 jì yù  
 favorable or unfavorable turns in life

### 纪 jì

① discipline ② put down in writing; record ③ age; epoch  
 纪念碑 jì niàn bēi  
 monument  
 纪念馆 jì niàn guǎn  
 memorial hall  
 纪行 jì xíng  
 travel notes

### 记 jì

① remember; bear in mind  
 ② write down; record  
 ③ notes; recork; sign  
 记号 jì hào  
 mark; sign; symbol  
 记事本 jì shì běn  
 notepad  
 记帐 jì zhàng  
 keep accounts

### 计 jì

① count; compute; calculate; number ② meter; gauge ③ idea; ruse; stratagem; plan  
 计划 jì huà  
 plan; project; program  
 计数 jì shù  
 count  
 计算机 jì suàn jī  
 computer

### 寄 jì

① send; post; mail ② entrust; deposit; place ③ depend on; attach oneself to  
 寄出 jì chū  
 send off  
 寄费 jì fèi  
 postage  
 寄件人 jì jiàn rén  
 sender

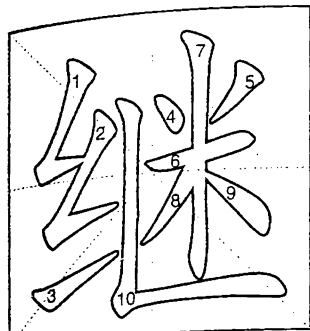

继 jì 691

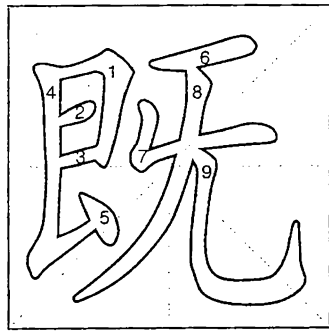

既 jì 692

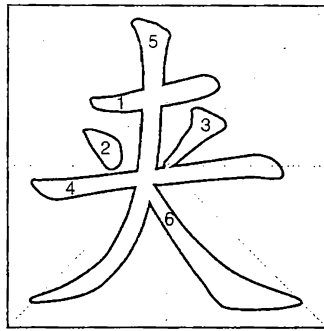

夹 jiā 693

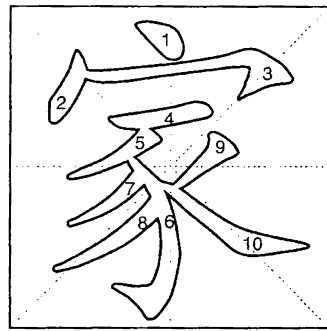

家 jiā 694

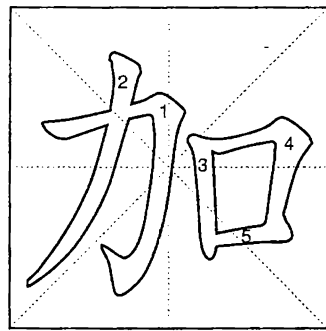

加 jiā 695

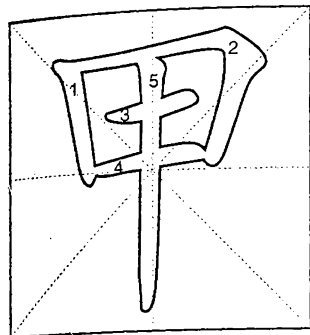

甲 jiǎ 696

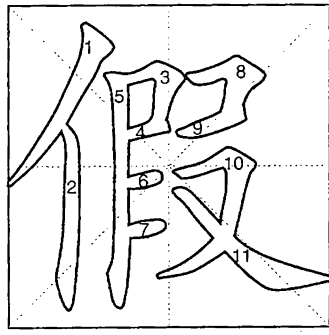

假 jiǎ 697

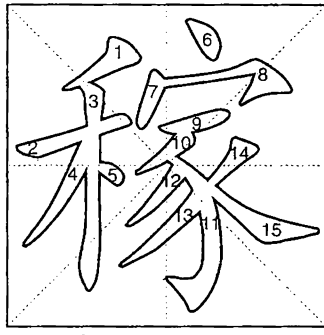

稼 jià 698

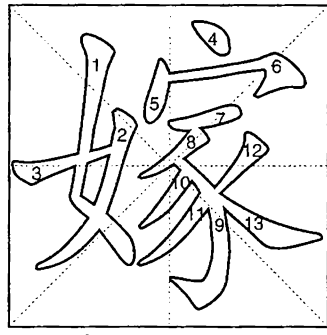

嫁 jià 699

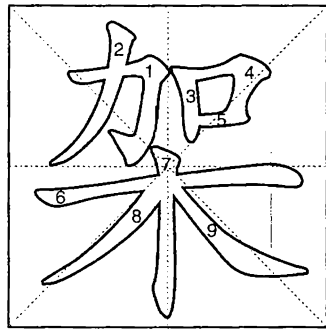

架 jià 700

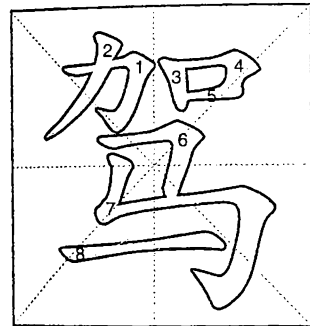

驾 jià 701

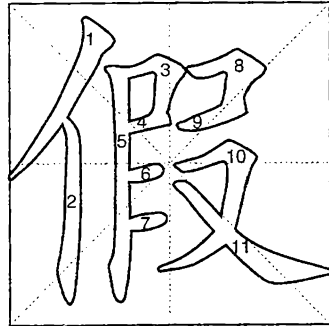

假 jià 702

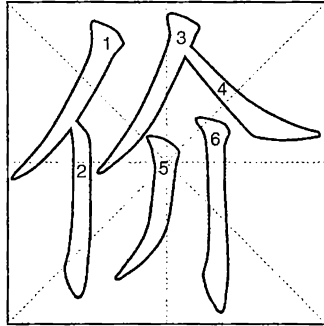

价 jià 703

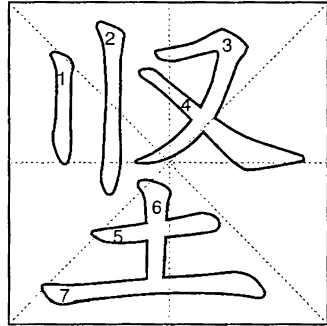

竖 jiān 704

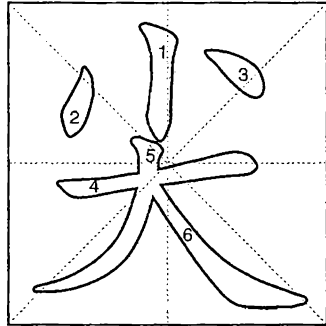

尖 jiān 705

### 加 jiā

① add; plus ② increase; augment ③ put in; add; append

加班 jiā'bān  
work overtime

加倍 jiā'bèi  
double

加仑 jiā'lún  
gallon

### 家 jiā

① family; household ② home ③ a person or family engaged in a certain trade ④ a specialist in a certain field

家当 jiā'dàng  
family belongings

家电 jiā'diàn  
household appliances

家具 jiā'jù  
furniture

### 夹 jiā

① press from both sides; place in between ② mix; mingle; intersperse ③ clip, clamp, folder, etc.

夹道 jiā'dào  
a narrow lane

夹克 jiā'kè  
jacket

夹子 jiā'zi  
clip; folder; wallet

### 既 jì

① already ② since; as; now that ③ both... and; as well as  
既不...也不... jì'bù...yě'bù...  
neither...nor...

既定 jì'dìng  
set; fixed; established

既然 jì'rán  
since; now that; as

### 继 jì

continue; succeed; follow  
继承 jì'chéng

inherit; carry on; succeed  
继电器 jì'diàn'qì

relay  
继父 jì'fù

stepfather

### 架 jià

① frame; rack; shelf; stand ② put up; erect ③ support; prop; help ④ kidnap ⑤ fight; quarrel

架构 jià'gòu  
framework; structure

架桥 jià'qiáo  
build a bridge; bridging

架子 jià'zi  
frame; stand

### 嫁 jià

① marry ② shift; transfer

嫁接(植) jià'jiē(zhí)  
graft

嫁娶 jià'qǔ  
marriage

嫁妆 jià'zhuang  
dowry; trousseau

### 稼 jià

① sow (grain) ② cereals; crops

庄稼 zhuāng'jià  
crops

### 假 jiǎ

① false; fake; phoney; artificial ② borrow; avail oneself of ③ if; suppose

假面舞会 jiǎ'miàn'wǔ'huì  
masquerade

假山 jiǎ'shān  
rockery

假牙 jiǎ'yá  
false tooth

### 甲 jiǎ

① first ② shell; carapace ③ nail ④ armor

甲板 jiǎ'bǎn  
deck

甲虫 jiǎ'chóng  
beetle

甲级 jiǎ'jí  
first division; first class

### 尖 jiān

① point; tip; top ② pointed; tapering ③ shrill; piercing ④ sharp; acute

尖兵 jiān'bīng  
pathbreaker

尖刀 jiān'dāo  
sharp knife; dagger

尖利 jiān'lì  
sharp; keen; cutting

### 坚 jiān

① hard; solid ② fortification; stronghold ③ firmly; steadfastly

坚持 jiān'chí  
insist on; stick to; keep up

坚决 jiān'jué  
firm; resolute

坚实 jiān'shí  
solid; substantial

### 价 jià

① price ② value

价格 jià'gé  
price

价钱 jià'qián  
price

### 假 jià

① holiday ② leave of absence

假期 jià'qī  
vacation; period of leave

假日 jià'rì  
holiday; day off

假条 jià'tiáo  
application for leave

### 驾 jià

① harness; draw (a cart, etc.) ② drive (a vehicle); pilot (a plane); sail (a boat)

驾驶 jià'shǐ  
drive; pilot; sail

驾校 jià'xiào  
driving school

驾照 jià'zhào  
driving licence

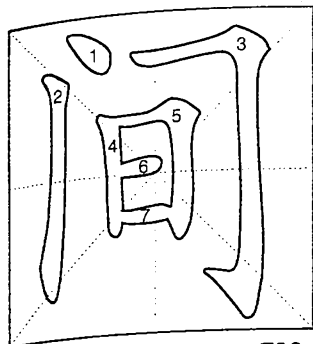

间 jiān 706

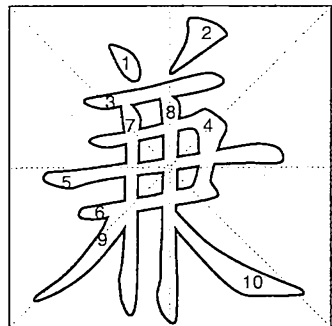

兼 jiān 707

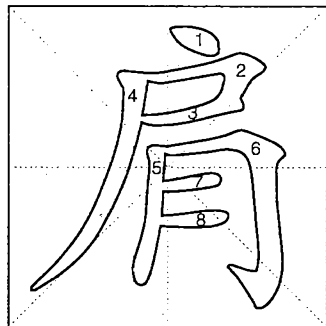

肩 jiān 708

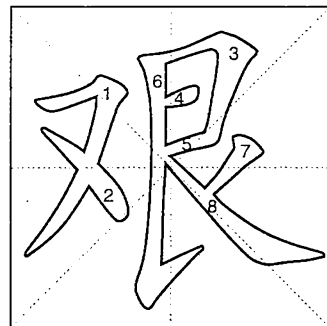

艰 jiān 709

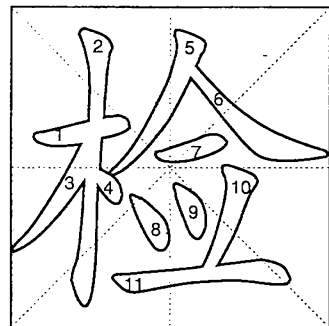

检 jiǎn 710

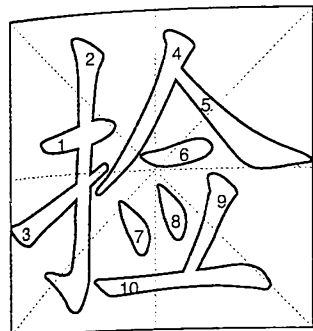

捡 jiǎn 711

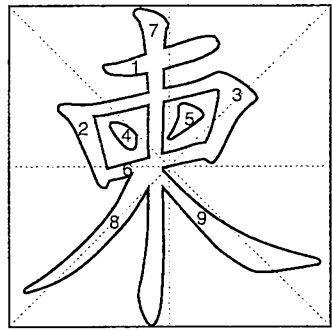

柬 jiǎn 712

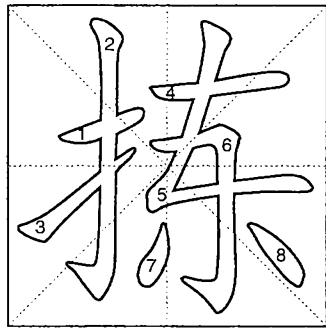

拣 jiǎn 713

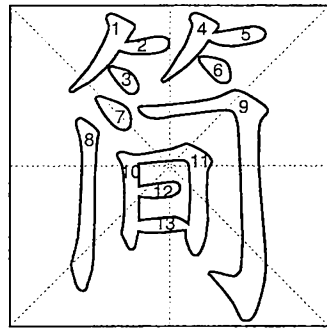

简 jiǎn 714

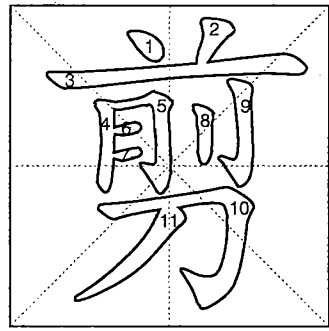

剪 jiǎn 715

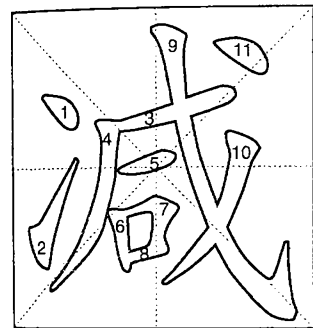

减 jiǎn 716

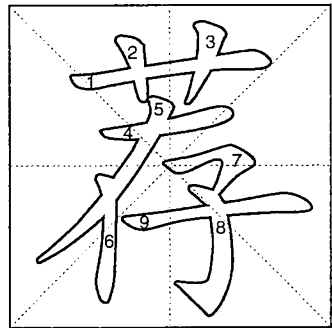

荐 jiàn 717

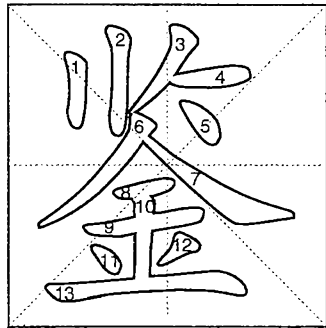

鉴 jiàn 718



践 jiàn 719

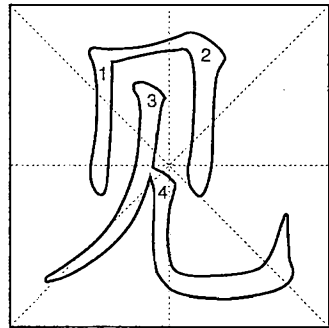

见 jiàn 720

### 检 jiǎn

check up  
 检查 jiǎn'chá  
 examine; check up  
 检查站 jiǎn'chá'zhàn  
 checkpost  
 检察院 jiǎn'chá'yuàn  
 procuratorate

### 艰 jiān

difficult; hard  
 艰苦 jiān'kǔ  
 difficult; hard; tough  
 艰难 jiān'nán  
 difficult; hard; arduous  
 艰辛 jiān'xīn  
 hardships

### 肩 jiān

①shoulder ②take on; bear  
 肩膀 jiān'bǎng  
 shoulder  
 肩并肩 jiān'bìng'jiān  
 side by side  
 肩负 jiān'fù  
 shoulder; bear; take on

### 兼 jiān

①double; twice  
 ②simultaneously; concurrently  
 兼并 jiān'bìng  
 annex (territory, etc.)  
 兼顾 jiān'gù  
 give consideration to two or more things  
 兼管 jiān'guǎn  
 be concurrently in charge of

### 间 jiān

①between; among ②within a definite time or space ③room  
 间距 jiān'jù  
 span

### 剪 jiǎn

①scissors; shears; clippers  
 ②cut (with scissors); clip  
 剪彩 jiǎn'cǎi  
 cut the ribbon  
 剪刀 jiǎn'dāo  
 scissors; shears; clippers  
 剪开 jiǎn'kāi  
 cut open

### 简 jiǎn

simple; simplified  
 简报 jiǎn'bào  
 briefing; bulletin  
 简单 jiǎn'dān  
 simple; brief; casual  
 简短 jiǎn'duǎn  
 short; brief

### 拣 jiǎn

choose; select; pick out  
 拣出 jiǎn'chū  
 pick out  
 拣拾 jiǎn'shí  
 pick up; collect; gather  
 拣选 jiǎn'xuǎn  
 choose; select; pick out

### 柬 jiǎn

card; note; letter  
 柬埔寨 jiǎn'pǔ'zhài  
 Cambodia  
 柬帖 jiǎn'tiē  
 note; short letter

### 捡 jiǎn

pick up; collect; gather  
 捡破烂 jiǎn'pò'làn  
 collect waste  
 捡起 jiǎn'qǐ  
 take up; pick up  
 捡拾 jiǎn'shí  
 pick up; collect

### 见 jiàn

①see; catch sight of ②meet with; be exposed to ③show evidence of ; appear to be  
 见鬼 jiàn'guǐ  
 fantastic; preposterous  
 见机行事 jiàn'jī'xíng'shì  
 do as one sees fit  
 见解 jiàn'jiě  
 opinion; view

### 践 jiàn

①trample; tread  
 ②act on; carry out  
 践踏 jiàn'tà  
 trample; tread on  
 践约 jiàn'yuē  
 keep a promise

### 鉴 jiàn

①reflect; mirror ②warning; object lesson ③inspect; examine  
 鉴别 jiàn'bié  
 distinguish; discriminate  
 鉴定 jiàn'dìng  
 appraisal; judge  
 鉴赏 jiàn'shǎng  
 appreciate

### 荐 jiàn

①recommend ②grass; straw  
 荐举 jiàn'jǔ  
 propose sb. for an office

### 减 jiǎn

①subtract ②reduce; decrease  
 减肥 jiǎn'féi  
 reduce (weight); slim  
 减价 jiǎn'jià  
 reduced price  
 减税 jiǎn'shuì  
 abatement of tax

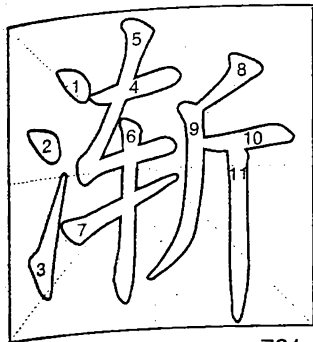

渐 jiàn 721

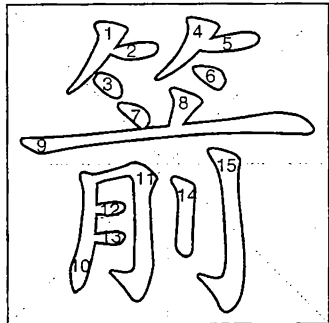

箭 jiàn 722



件 jiàn 723

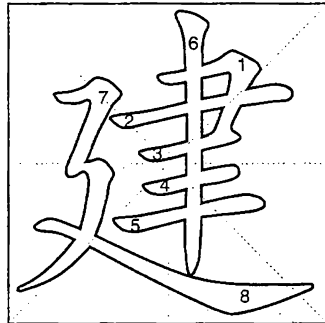

建 jiàn 724

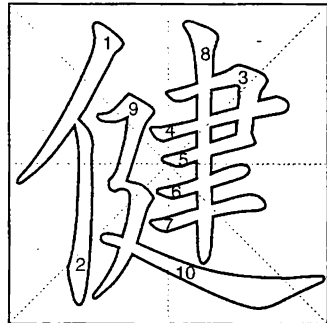

健 jiàn 725

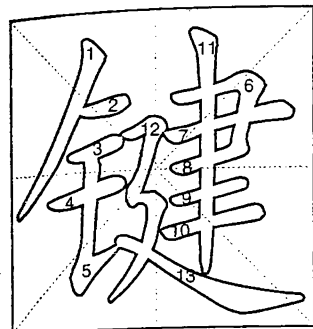

键 jiàn 726

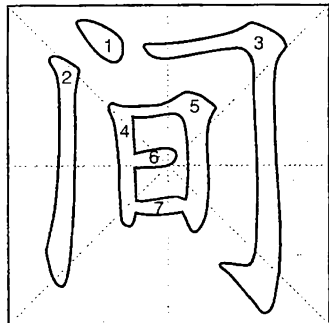

间 jiàn 727

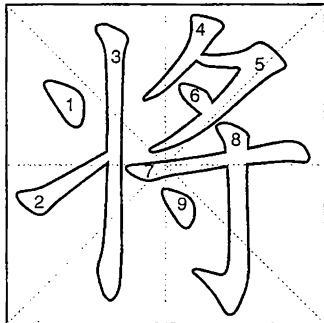

将 jiāng 728

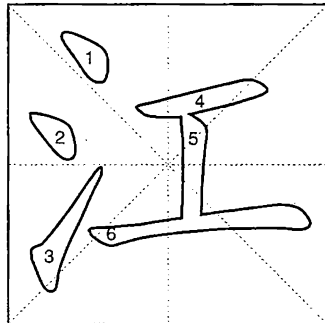

江 jiāng 729

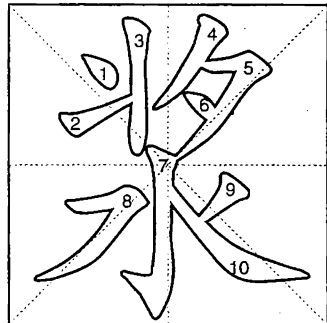

浆 jiāng 730

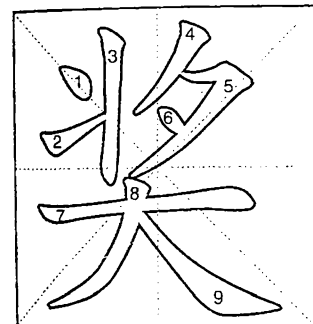

浆 jiǎng 731



讲 jiǎng 732

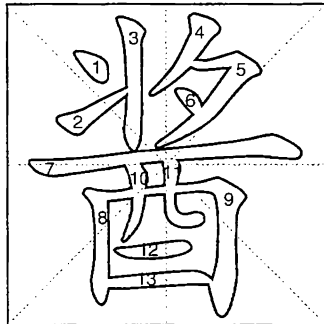

酱 jiàng 733

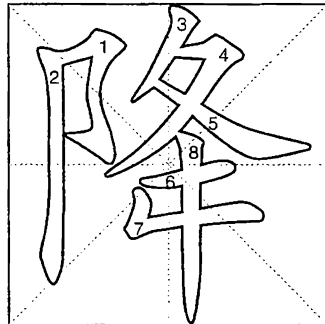

降 jiàng 734

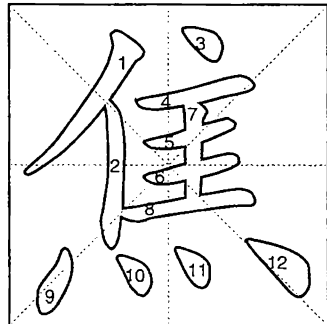

焦 jiāo 735

### 健 jiàn

- ① healthy; strong ② strengthen  
③ be strong in  
健康 jiàn'kāng  
good health; healthy  
健美操 jiàn'měi'cāo  
aerobics exercises  
健忘 jiàn'wàng  
forgetful; liable to forget

### 建 jiàn

- ① build; erect ② establish; set up; found ③ propose; advocate  
建材 jiàn'cái  
building materials  
建交 jiàn'jiāo  
establish diplomatic relations  
建议 jiàn'yì  
propose; suggest

### 件 jiàn

- ① piece ② letter; correspondence  
信件 xìn'jiàn  
letter; mail

### 箭 jiàn

- arrow  
箭靶 jiàn'bǎ  
target for archery  
箭步 jiàn'bù  
quick jump  
箭头 jiàn'tóu  
arrowhead; arrow

### 渐 jiàn

- gradually; by degrees  
渐变 jiàn'biàn  
gradual change  
渐渐 jiàn'jiàn  
little by little; gradually  
渐进 jiàn'jìn  
advance gradually

### 浆 jiāng

- ① thick liquid ② starch  
浆果 jiāng'guǒ  
berry  
浆洗 jiāng'xǐ  
wash and starch

### 江 jiāng

- river  
江河 jiāng'hé  
rivers  
江湖义气 jiāng'hú'yì'qì  
brotherhood  
江畔 jiāng'pàn  
river bank

### 将 jiāng

- ① support; take; bring  
② take care of (one's health)  
③ do sth.; handle (a matter)  
④ put sb. on the spot  
将军 jiāng'jūn  
general; (棋) check; embarrass  
将来 jiāng'lái  
future; in the future  
将信将疑 jiāng'xìn'jiāng'yí  
half believe and half doubt

### 间 jiàn

- ① space in between; opening  
② separate ③ sow discord ④ thin out (seedlings)  
间谍 jiàn'dié  
spy  
间接 jiàn'jiē  
indirect; secondhand  
间歇 jiàn'xiē  
intermittence

### 键 jiàn

- key  
键盘 jiàn'pán  
keyboard  
键入 jiàn'rù  
key in

### 焦 jiāo

- ① burnt; scorched; charred  
② coke ③ worried; anxious  
焦点 jiāo'diǎn  
focal point; central issue  
焦急 jiāo'jí  
anxious; worried  
焦虑 jiāo'lù  
feel anxious

### 降 jiàng

- fall; drop; lower  
降低 jiàng'dī  
lower; reduce; drop  
降价 jiàng'jià  
lower prices  
降落伞 jiàng'luò'sǎn  
parachute

### 酱 jiàng

- ① a thick sauce made from soya beans, flour, etc. ② cooked or pickled in soy sauce ③ sauce; paste; jam  
酱菜 jiàng'cài  
pickles  
酱肉 jiàng'ròu  
pork cooked in soy sauce  
酱油 jiàng'yóu  
soy (sauce)

### 讲 jiǎng

- ① speak; say; tell ② explain; make clear; interpret ③ discuss; negotiate  
④ stress; pay attention to  
讲和 jiǎng'hé  
make peace  
讲课 jiǎng'kè  
teach; lecture  
讲义 jiǎng'yì  
teaching materials

### 奖 jiǎng

- ① encourage; praise; reward  
② award; prize  
奖杯 jiǎng'bēi  
cup  
奖金 jiǎng'jīn  
bonus; prize; premium  
奖学金 jiǎng'xué'jīn  
scholarship

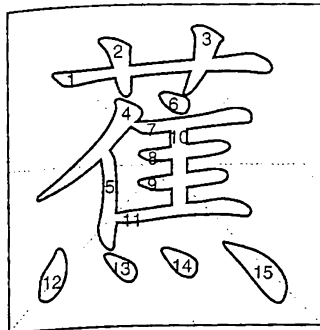

蕉 jiāo 736



椒 jiāo 737

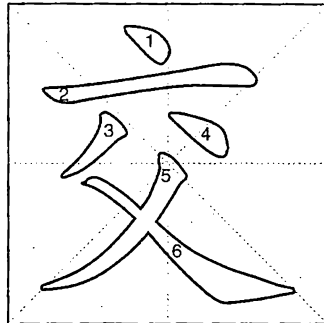

交 jiāo 738

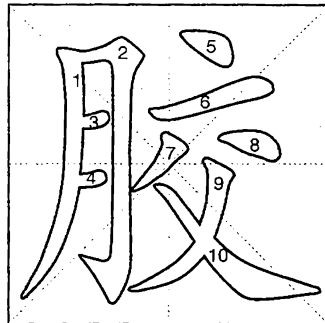

胶 jiāo 739



郊 jiāo 740

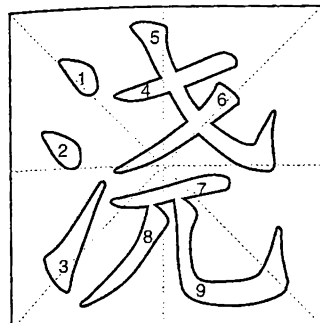

浇 jiāo 741



骄 jiāo 742

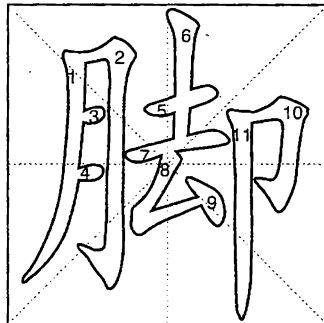

脚 jiǎo 743

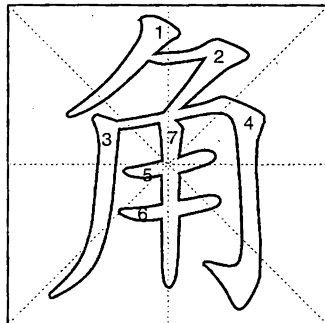

角 jiǎo 744

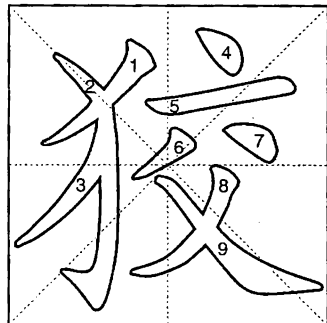

狡 jiǎo 745

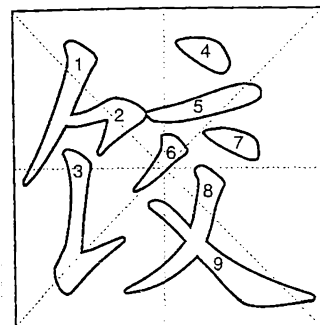

饺 jiǎo 746

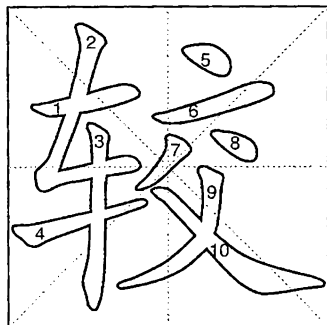

较 jiào 747

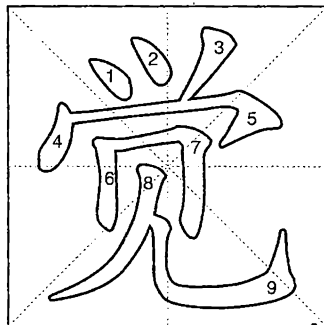

觉 jiào 748

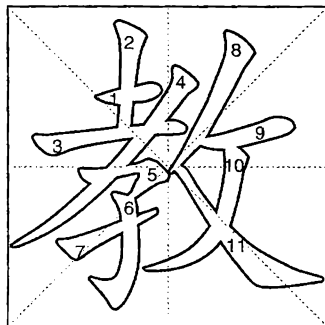

教 jiào 599

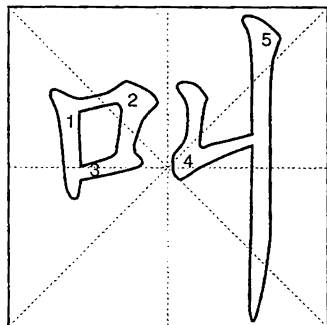

叫 jiào 750



**郊 jiāo**

suburbs  
郊区 jiāo'qū  
suburbs; outskirts  
郊外 jiāo'wài  
outskirts  
郊游 jiāo'yóu  
outing

**胶 jiāo**

①glue; gum ②stick with glue; glue  
③gluey; sticky; gummy ④rubber  
胶布 jiāo'bù  
adhesive plaster  
胶片 jiāo'piàn  
film  
胶水 jiāo'shuǐ  
glue

**交 jiāo**

①hand over; give up; deliver  
②meet; join ③reach (a certain  
hour or season) ④cross; intersect  
⑤associate with  
交叉 jiāo'chā  
cross; intersect  
交代 jiāo'dài  
hand over; tell; confess  
交付 jiāo'fù  
pay; hand to; deliver to

**椒 jiāo**

any of several hot spice plants  
椒盐 jiāo'yán  
spiced salt

**蕉 jiāo**

any of several broadleaf plants  
香蕉 xiāng'jiāo  
banana  
芭蕉 bā'jiāo  
banana

**狡 jiǎo**

crafty; foxy; cunning  
狡辩 jiǎo'biàn  
quibble  
狡猾〈滑〉 jiǎo'huá'huá'  
sly; crafty  
狡赖 jiǎo'lài  
deny  
狡诈 jiǎo'zhà  
deceitful; crafty; cunning

**角 jiǎo**

①horn ②bugle ③corner ④an-  
gle ⑤cape; promontory; headland  
角度 jiǎo'dù  
angle; point of view  
角膜 jiǎo'mó  
cornea  
角球〈足球〉 jiǎo'qiú'zú'qiú'  
corner (kick)

**脚 jiǎo**

①foot ②base; foot ③leg  
脚本 jiǎo'běn  
script; scenario  
脚刹车 jiǎo'shā'chē  
foot brake  
脚注 jiǎo'zhù  
footnote

**骄 jiāo**

proud  
骄傲 jiāo'ào  
arrogant; proud; pride  
骄横 jiāo'hèng  
arrogant and imperious  
骄气 jiāo'qì  
overbearing airs

**浇 jiāo**

①pour liquid on; sprinkle water on  
②irrigate; water  
浇灌 jiāo'guàn  
water; irrigate  
浇水 jiāo'shuǐ  
water ~壶 watering-can  
浇铸 jiāo'zhù  
casting; pouring

**叫 jiào**

①cry; shout ②call; greet ③hire;  
order ④name; call ⑤ask; order  
叫喊 jiào'hǎn  
cry, shout(at); yell  
叫好 jiào'hǎo  
applaud  
叫醒 jiào'xǐng  
wake up

**教 jiào**

①teach; instruct ②religion  
教材 jiào'cái  
teaching material  
教父 jiào'fù  
god-father  
教师 jiào'shī  
teacher; instructor

**觉 jiào**

sleep

**较 jiào**

①compare ②comparatively;  
quite; rather  
较差 jiào'chà  
relatively poor  
较好 jiào'hǎo  
better  
较量 jiào'liàng  
match; have a contest

**饺 jiǎo**

dumpling  
饺子 jiǎo'zi  
dumpling

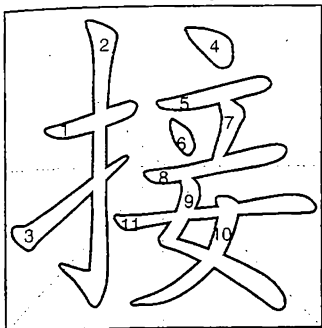

接 jiē 751

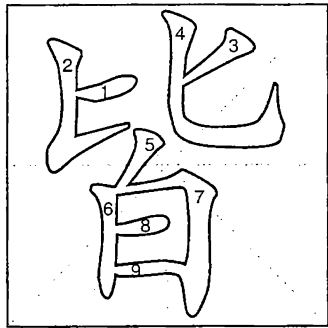

皆 jiē 752

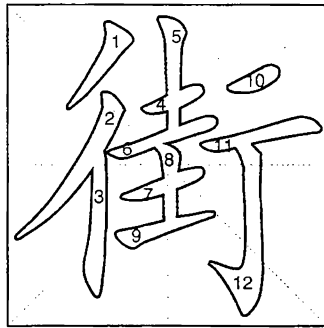

街 jiē 753

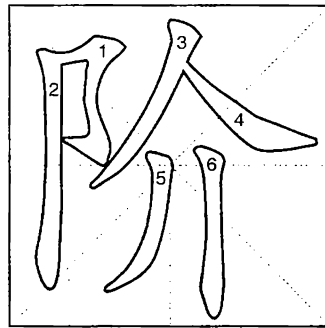

阶 jiē 754

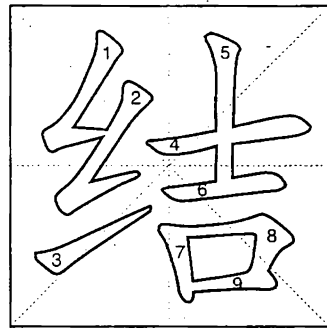

结 jiē 755

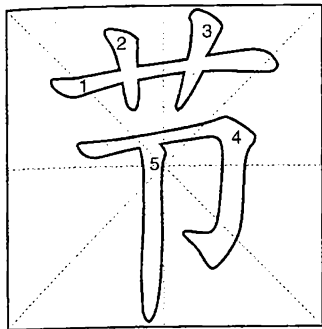

节 jié 756

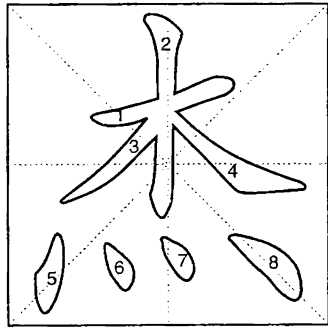

杰 jié 757

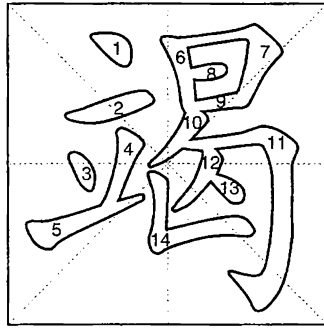

竭 jié 758

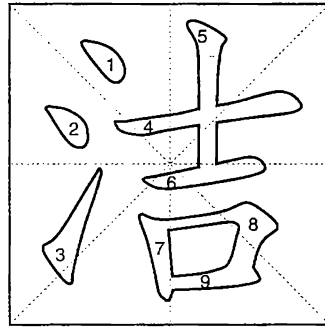

洁 jié 759

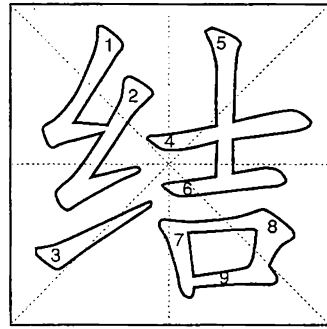

结 jié 760

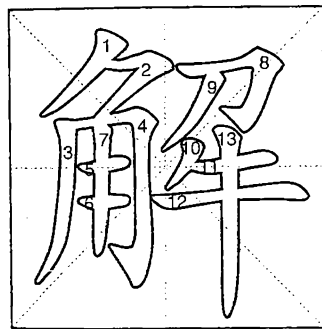

解 jiě 761

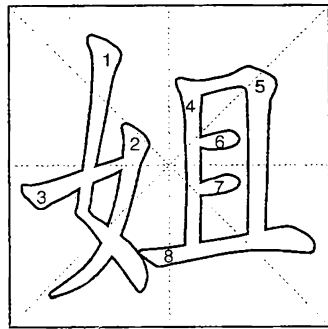

姐 jiě 762

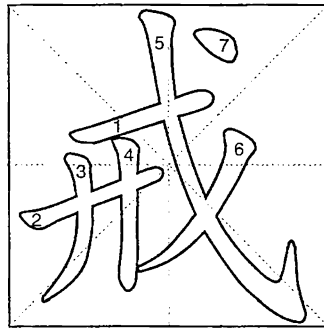

戒 jiè 763

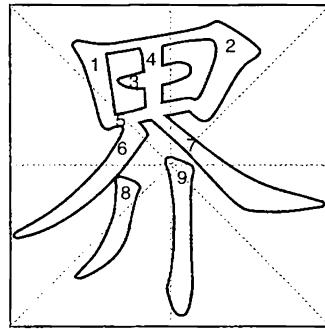

界 jiè 764

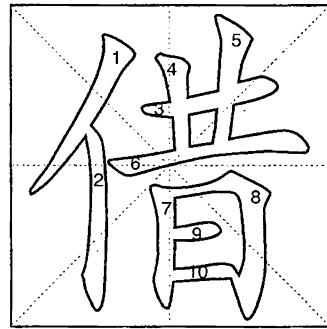

借 jiè 765

### 结 jiē

bear (fruit); form (seed)  
 结巴 jiē'ba  
 stammer; stutter  
 结果 jiē'guǒ  
 bear fruit  
 结实 jiē'shi  
 sturdy; strong; stout

### 阶 jiē

①steps; stairs ②rank

### 街 jiē

street  
 街道 jiē'dào  
 street  
 街坊 jiē'fang  
 neighbour  
 街区 jiē'qū  
 block; sub-district

### 皆 jiē

all; each and every  
 皆大欢喜 jiē'dà'huān'xǐ  
 everybody is happy

### 接 jiē

①come into contact with; come close to ②connect; join ③catch; take hold of ④receive  
 接待 jiē'dài  
 receive; admit  
 接二连三 jiē'èr'lián'sān  
 one after another  
 接吻 jiē'wěn  
 kiss

### 结 jié

①tie; knit; knot; weave  
 ②knot ③congeal; form; forge; cement ④settle; conclude  
 结冰 jié'bīng  
 freeze; ice up  
 结合 jié'hé  
 combine; marry  
 结婚 jié'hūn  
 marry; get married

### 洁 jié

clean  
 洁白 jié'bái  
 pure white  
 洁净 jié'jìng  
 clean; spotless  
 洁身自好 jié'shēn'zì'hào  
 preserve one's purity

### 竭 jié

use up  
 竭诚 jié'chéng  
 whole-heartedly  
 竭尽 jié'jìn  
 use up; exhaust  
 竭力 jié'lì  
 do one's utmost

### 杰 jié

① prominent ② outstanding  
 person; hero  
 杰出 jié'chū  
 outstanding; prominent  
 杰作 jié'zuò  
 masterpiece

### 节 jié

① joint; node; knot ② division; part ③ section; length ④ festival; holiday ⑤abridge  
 节目 jié'mù  
 programme; item  
 节省 jié'shěng  
 economize; save  
 节奏 jié'zòu  
 rhythm

### 借 jiè

①borrow (sth. from sb.) ②lend  
 ③make use of ④use as a pretext  
 借出 jiè'chū  
 lend  
 借口 jiè'kǒu  
 excuse; pretext  
 借用 jiè'yòng  
 borrow

### 界 jiè

①boundary ②scope; extent  
 ③ circles ④ primary division;  
 kingdom  
 界标 jiè'biāo  
 landmark; boundary sign  
 界限 jiè'xiàn  
 limits; bounds  
 界线 jiè'xiàn  
 boundary line

### 戒 jiè

①guard against  
 ②give up; drop; stop  
 ③(finger) ring  
 戒除 jiè'chú  
 give up; drop; leave off  
 戒毒 jiè'dú  
 come off drugs; drug detoxification  
 戒烟 jiè'yān  
 abstain from tobacco

### 姐 jiě

elder sister  
 姐夫 jiě'fū  
 brother-in-law  
 姐姐 jiě'jie  
 elder sister  
 姐妹 jiě'mèi  
 sisters:同胞~full sister

### 解 jiě

①separate; divide ②untie; undo  
 ③allay; dispel; dismiss ④explain  
 解除 jiě'chú  
 get rid of; remove  
 解手 jiě'shǒu  
 go to the toilet  
 解约 jiě'yuē  
 terminate an agreement

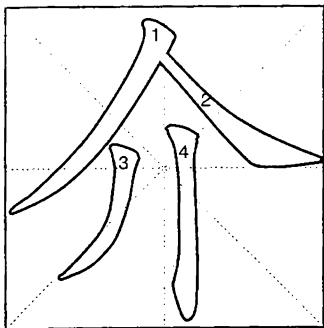

介 jiè

766

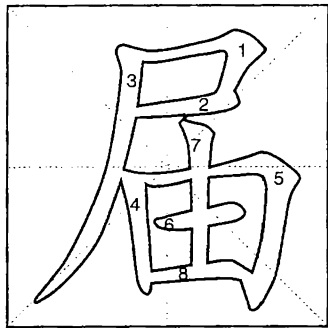

届 jiè

767

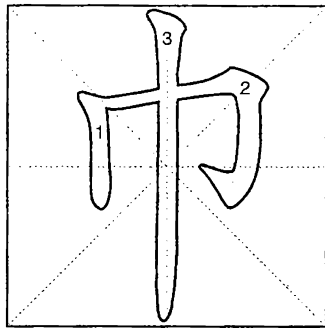

巾 jīn

768

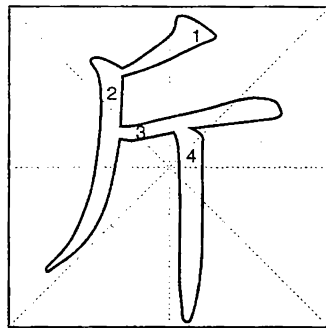

斤 jīn

769

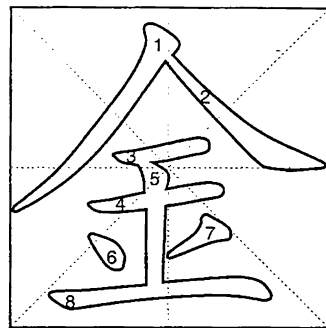

金 jīn

770

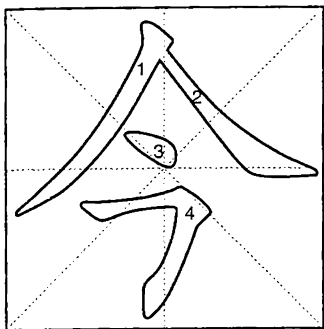

今 jīn

771



津 jīn

772

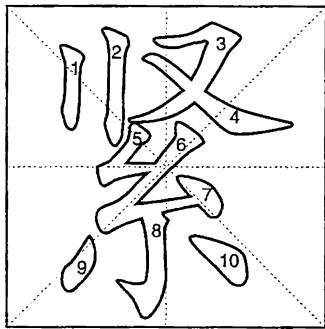

紧 jǐn

773

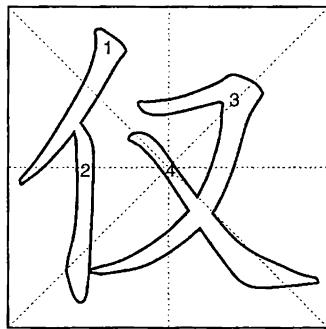

仅 jǐn

774

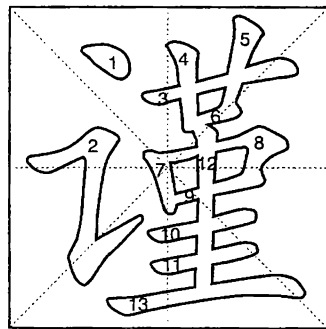

谨 jǐn

775

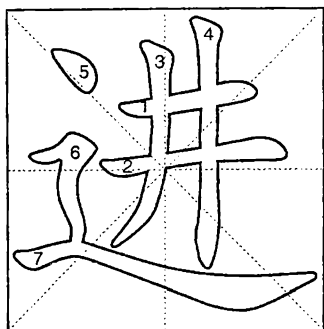

进 jìn

776

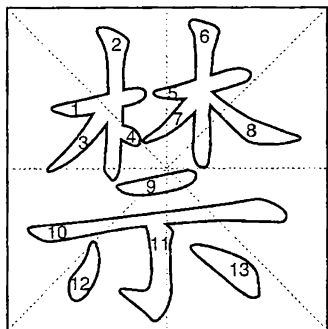

禁 jìn

777

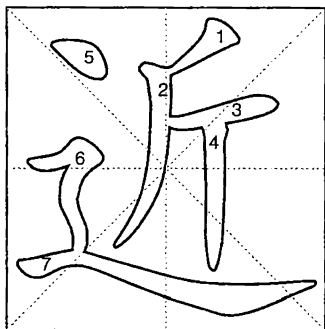

近 jìn

778

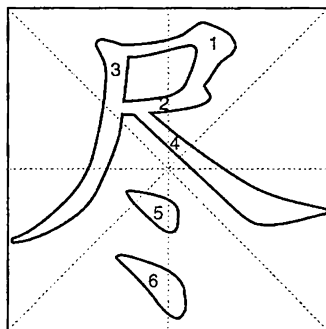

尽 jìn

779

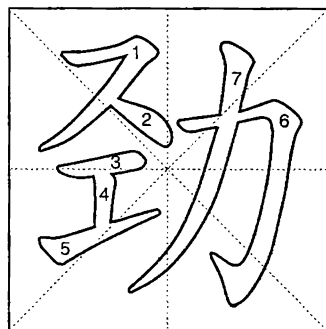

劲 jìn

780

### 金 jīn

- ①metals ②money ③gold  
④golden  
金杯 jīn'bēi  
gold cup  
金戒指 jīn'jiè'zhǐ  
gold ring  
金鱼 jīn'yú  
goldfish

### 斤 jīn

- a unit of weight (=1/2 kilogram)  
斤斤计较 jīn'jīn'jì'jiào  
haggle over every ounce  
斤两 jīn'liǎng  
weight

### 巾 jīn

- a piece of cloth (as used for a  
towel, scarf, kerchief, napkin, etc.)  
巾帼 jīn'guó  
woman  
巾帼英雄 jīn'guó'yīng'xióng  
heroine

### 届 jiè

- fall due  
届时 jiè'shí  
on the occasion

### 介 jiè

- ①be situated between; interpose  
②take seriously; take to heart; mind  
介绍 jiè'shào  
introduce; present  
介绍信 jiè'shào'xìn  
letter of introduction  
介意 jiè'yì  
mind; care about

### 谨 jǐn

- ①careful; cautious  
②solemnly; sincerely  
谨防 jǐn'fáng  
beware (cautious) of  
谨上 jǐn'shàng  
sincerely yours  
谨慎 jǐn'shèn  
careful; cautious; prudent

### 仅 jǐn

- only; merely; barely  
仅次于 jǐn'cì'yú  
second only to; next to  
仅供参考 jǐn'gōng'cān'kǎo  
for reference only  
仅仅 jǐn'jǐn  
merely; only; barely

### 紧 jǐn

- ①tight; taut; close ②tighten  
③urgent; pressing; tense ④strict;  
stringent ⑤hard up  
紧抱 jǐn'bào  
hug; give sb. a hug  
紧密 jǐn'mì  
close together  
紧迫 jǐn'pò  
pressing; urgent

### 津 jīn

- ①ferry crossing; ford ②saliva  
③sweat  
津津乐道 jīn'jīn'lè'dào  
talk with great relish  
津津有味 jīn'jīn'yǒu'wèi  
with relish; with gusto  
津贴 jīn'tiē  
subsidy; allowance

### 今 jīn

- ①modern; present-day ②today  
③this (year) ④now; the present  
今年 jīn'nián  
this year  
今天 jīn'tiān  
today; present; now  
今晚 jīn'wǎn  
tonight; this evening

### 劲 jìn

- ①strength; energy ②vigour;  
spirit; drive; zeal  
劲头 jìn'tóu  
strength; energy; vigor

### 尽 jìn

- ①exhausted; finished ②to the  
utmost; to the limit ③use up; ex-  
haust ④try one's best; put to the  
best use  
尽力 jìn'li  
do one's best  
尽头 jìn'tóu  
the end  
尽职 jìn'zhí  
do one's duty

### 近 jìn

- ①near; close  
②approximately; close to  
近代 jìn'dài  
modern times  
近郊 jìn'jiāo  
outskirts of a city  
近路 jìn'lù  
a short cut

### 禁 jìn

- ①prohibit; forbid; ban ②detain  
③taboo  
禁毒 jìn'dú  
ban the production, sale and  
abuse of drugs  
禁令 jìn'ling  
ban; prohibition  
禁区 jìn'qū  
forbidden zone

### 进 jìn

- ①advance; move ahead ②enter;  
come or go into; get into ③receive  
④eat; drink; take ⑤submit; present  
进步 jìn'bù  
advance; progress  
进城 jìn'chéng  
go to town  
进出 jìn'chū  
pass in and out

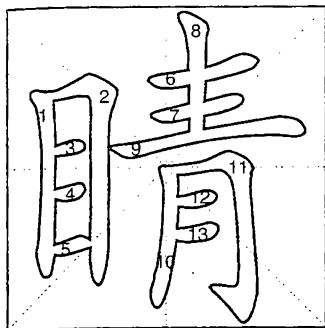

睛 jīng 781

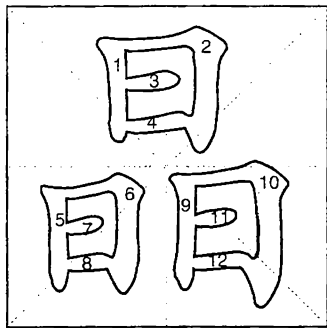

晶 jīng 782

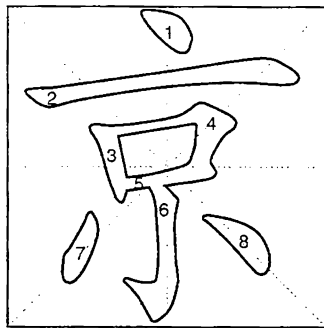

京 jīng 783

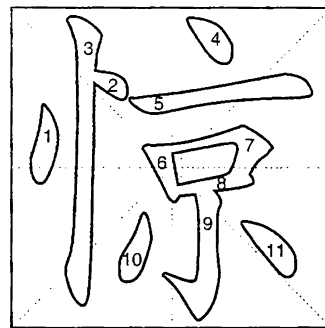

惊 jīng 784

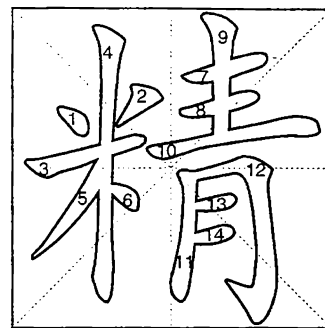

精 jīng 785

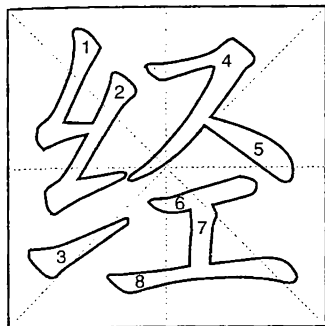

经 jīng 786

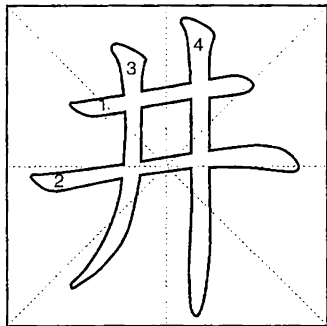

井 jǐng 787

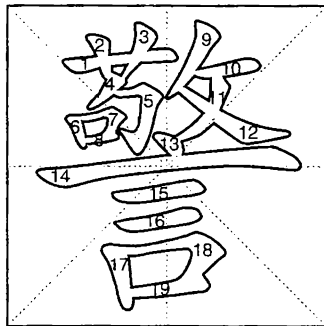

警 jǐng 788

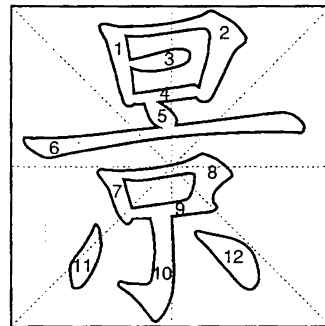

景 jǐng 789

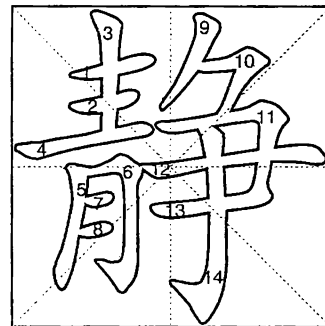

静 jìng 790

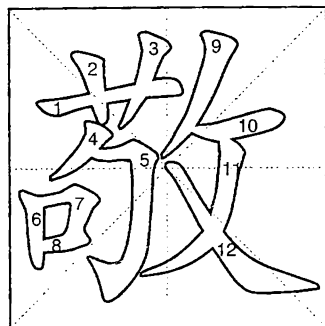

敬 jìng 791

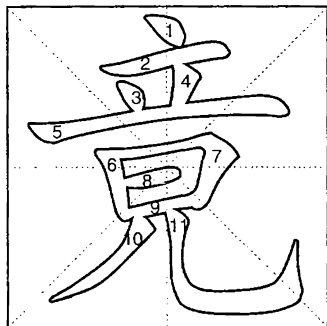

竞 jìng 792

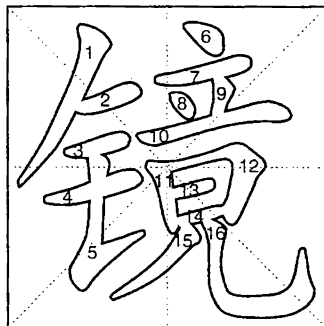

镜 jìng 793

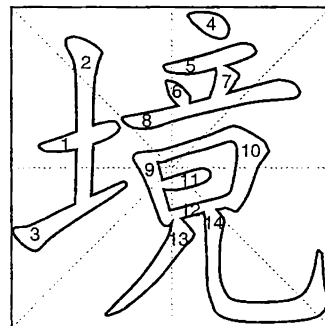

境 jìng 794

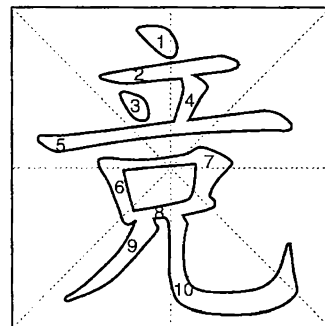

竞 jìng 795

**精 jīng**

- ①refined; picked; choiced  
 ②essence; extract ③perfect; excellent ④meticulous; fine; precise  
 ⑤smart; sharp; clever  
 精彩 jīng'cǎi  
 wonderful; splendid  
 精品 jīng'pǐn  
 fine works; quality goods  
 精心 jīng'xīn  
 the best of care

**惊 jīng**

- ①start; be frightened ②surprise; shock; alarm ③shy; stampede  
 惊人 jīng'rén  
 astonishing; amazing  
 惊喜 jīng'xǐ  
 pleasantly surprised  
 惊醒 jīng'xǐng  
 wake up with a start

**京 jīng**

- ①capital (of a country)  
 ②short for Beijing  
 京城 jīng'chéng  
 the capital of a country  
 京胡 jīng'hú  
 2-stringed Chinese violin  
 京剧 jīng'jù  
 Beijing Opera

**晶 jīng**

- ①glittering  
 ②quartz; (rock)crystal  
 晶体 jīng'tǐ  
 crystal  
 晶体管 jīng'tǐ'guǎn  
 transistor

**睛 jīng**

eyeball

**静 jìng**

- still; quiet; calm  
 静电 jìng'diàn  
 static electricity  
 静脉 jìng'mài  
 vein  
 静悄悄 jìng'qiāo'qiāo  
 very quiet

**景 jǐng**

- ①view; scenery; scene ②situation; condition ③scenery (of a play or film) ④scene (of a play)  
 景点 jǐng'diǎn  
 scenic spots  
 景观 jǐng'guān  
 landscape  
 景色 jǐng'sè  
 view; scenery

**警 jǐng**

- ①alert; vigilant ②warn; alarm  
 ③alarm ④police  
 警察 jǐng'chá  
 police; policeman  
 警车 jǐng'chē  
 patrol wagon  
 警卫 jǐng'wèi  
 (security) guard

**井 jǐng**

- well  
 井架〈石油〉 jǐng'jià (shí'yóu)  
 derrick  
 井口 jǐng'kǒu  
 the mouth of a well  
 井水 jǐng'shuǐ  
 well water

**经 jīng**

- ①manage; deal in ②constant; regular ③scripture; canon; classics  
 ④menses ⑤pass through; undergo  
 经费 jīng'fèi  
 funds; expenditure  
 经济舱 jīng'jī'cāng  
 economy class  
 经理 jīng'lǐ  
 manager

**竞 jìng**

- compete; contest; vie  
 竞标 jìng'biāo  
 compete in bidding  
 竞买 jìng'mǎi  
 compete to buy  
 竞卖 jìng'mài  
 compete to sell

**境 jìng**

- ①border; boundary ②place; area ③situation  
 境地 jìng'dì  
 condition; circumstances  
 境界 jìng'jiè  
 boundary; state; realm  
 境况 jìng'kuàng  
 circumstances; condition

**镜 jìng**

- ①looking glass; mirror  
 ②lens; glass  
 镜片 jìng'piàn  
 lens  
 镜头 jìng'tóu  
 camera lens; shot  
 镜子 jìng'zi  
 mirror; looking glass

**竟 jìng**

- ①finish; complete ②throughout; whole ③in the end; eventually  
 竟敢 jìng'gǎn  
 dare; have the audacity  
 竟然 jìng'rán  
 to one's surprise; even

**敬 jìng**

- ①respect; esteem  
 ②offer politely  
 敬老院 jìng'lǎo'yuàn  
 old folks' home  
 敬礼 jìng'lǐ  
 salute; with best wishes  
 敬重 jìng'zhòng  
 honour



净 jìng 796

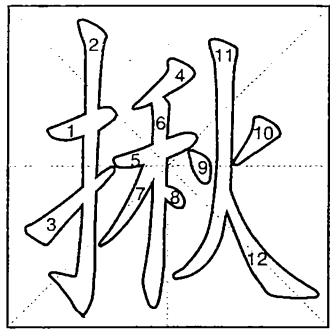

揪 jiū 797

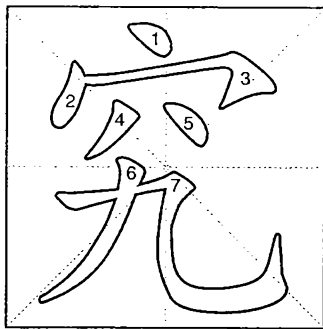

究 jiū 798

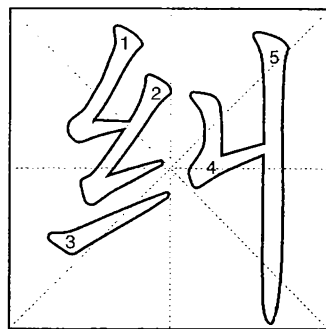

纠 jiū 799

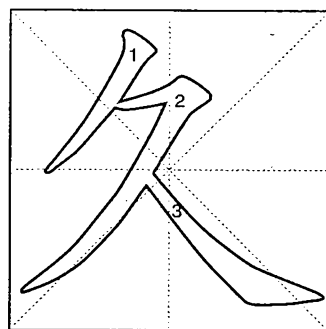

久 jiǔ 800

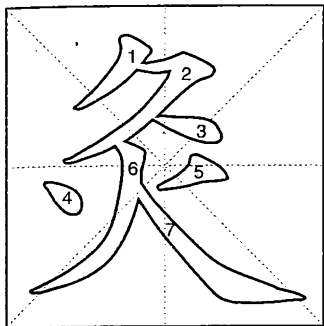

灸 jiǔ 801

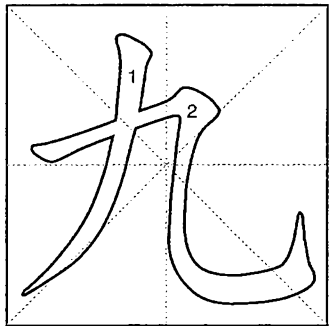

九 jiǔ 802

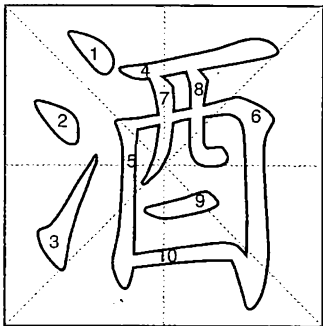

酒 jiǔ 803

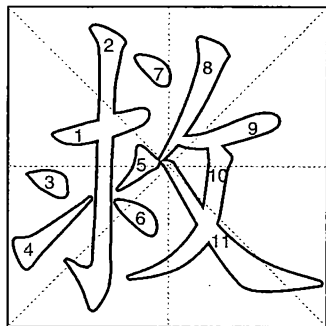

救 jiù 804

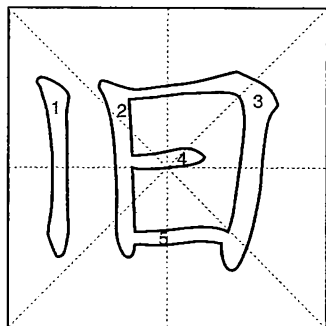

旧 jiù 805



舅 jiù 806

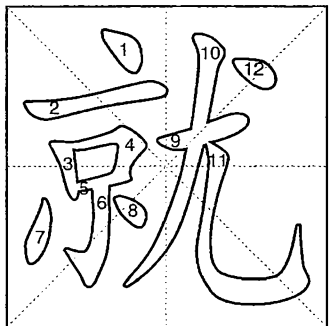

就 jiù 807

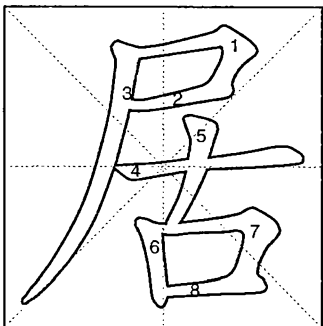

居 jū 808

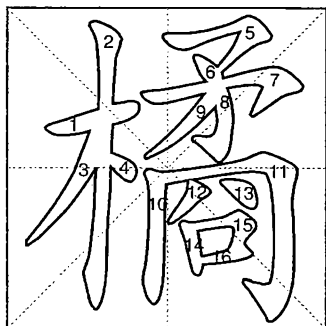

橘 jú 809

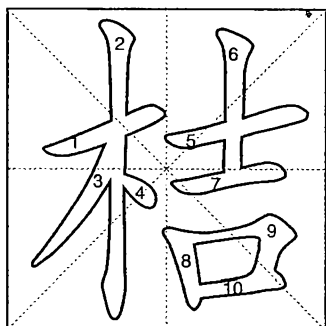

桔 jú 810



### 久 jiǔ

for a long time; long  
久别 jiǔ'bié  
long separation  
久违 jiǔ'wéi  
haven't seen you for ages  
久仰 jiǔ'yǎng  
very pleased to meet you

### 纠 jiū

①entangle ②gather together  
③correct; rectify  
纠察 jiū'chá  
picket  
纠纷 jiū'fēn  
dispute; issue  
纠正 jiū'zhèng  
correct; put right

### 究 jiū

study carefully; go into  
究办 jiū'bàn  
investigate and deal with  
究竟 jiū'jìng  
outcome; exactly; after all

### 揪 jiū

①hold tight; seize ②pull; tug;  
drag  
揪辫子 jiū'biàn'zi  
seize sb.'s mistakes  
揪出 jiū'chū  
uncover; ferret out

### 净 jìng

①clean ②completely ③only;  
merely; nothing but ④net  
净额 jìng'é  
net amount  
净收入 jìng'shōu'rù  
net income  
净重 jìng'zhòng  
net weight

### 旧 jiù

①past; bygone; old ②used;  
worn; old  
旧货 jiù'huò  
secondhand goods  
旧式 jiù'shì  
old type  
旧友 jiù'yǒu  
old friend

### 救 jiù

①rescue; save; salvage  
②help; relieve; succour  
救护车 jiù'hù'chē  
ambulance  
救生圈 jiù'shēng'quān  
lifebelt; life buoy  
救助 jiù'zhù  
help sb. in danger

### 酒 jiǔ

alcoholic drink; wine; liquor;  
spirits  
酒吧(间) jiǔ'bā(jiān)  
bar; barroom  
酒杯 jiǔ'bēi  
wine glass; wine bowl  
酒窝 jiǔ'wō  
dimple

### 九 jiǔ

nine  
九牛一毛 jiǔ'niú'yí'máo  
a drop in the ocean  
九十 jiǔ'shí  
ninety  
九月 jiǔ'yuè  
September

### 灸 jiǔ

moxibustion  
针灸 zhēn'jiǔ  
moxibustion

### 桔 jú

桔子 jú'zi  
tangerine

### 橘 jú

tangerine  
橘皮 jú'pí  
orange peel  
橘子 jú'zi  
tangerine

### 居 jū

①reside; dwell; live ②resi-  
dence; house 迁~ move house ③be  
(in a certain position); occupy (a  
place) ④claim; assert  
居民 jū'mín  
resident; inhabitant  
居室 jū'shì  
room  
居住 jū'zhù  
live; dwell; inhabit

### 就 jiù

①come near; move towards  
②undertake; engage in; enter upon  
③accomplish; make ④accommodate  
oneself to; suit; fit ⑤go with  
就任 jiù'rèn  
take office  
就学 jiù'xué  
go to school  
就业 jiù'yè  
get a job

### 舅 jiù

mother's brother; wife's brother  
舅父 jiù'fù  
mother's brother; uncle  
舅母 jiù'mǔ  
wife of mother's brother

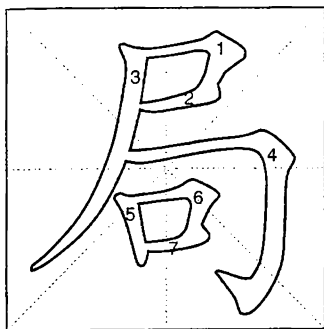

局 jú 811

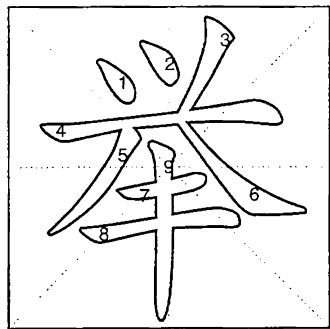

举 jǔ 812

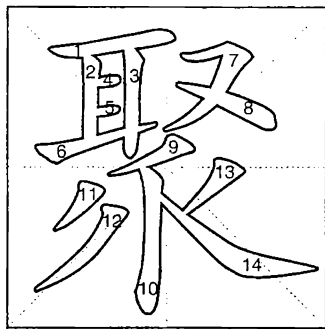

聚 jù 813

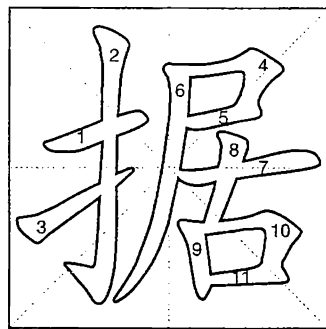

据 jù 814

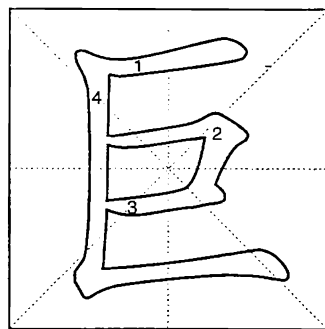

巨 jù 815

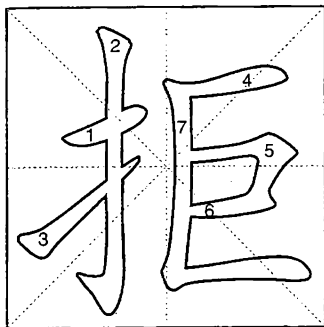

拒 jù 816

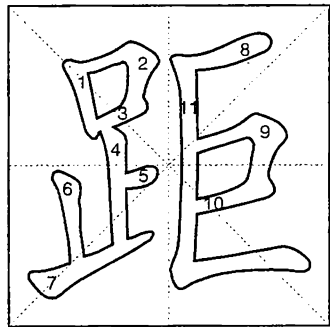

距 jù 817

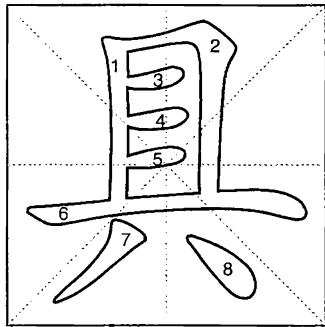

具 jù 818

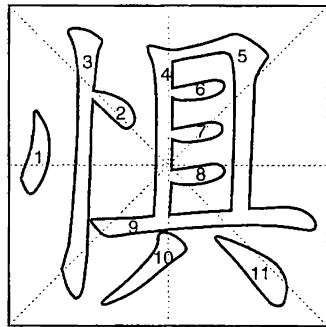

惧 jù 819

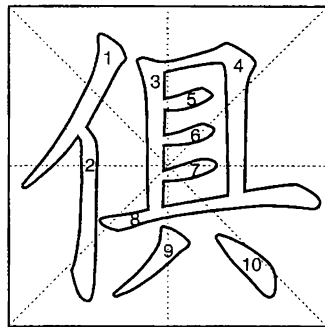

俱 jù 820

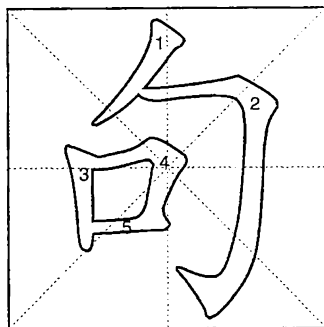

句 jù 821

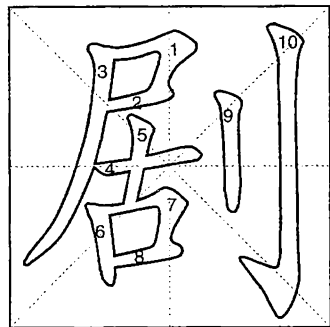

剧 jù 822



卷 juǎn 823

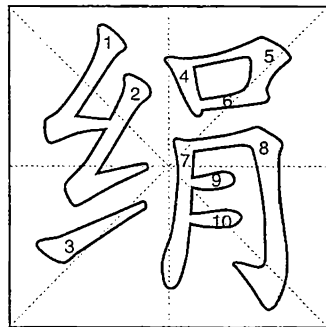

绢 juàn 824

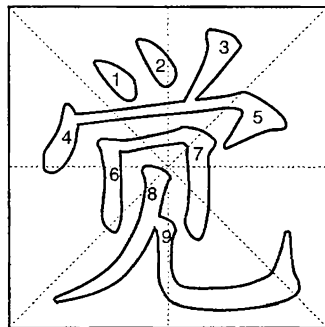

觉 jué 825

## 巨 jù

huge; gigantic  
 巨变 jù'biàn  
 great change  
 巨人 jù'rén  
 giant  
 巨著 jù'zhù  
 monumental work

## 据 jù

①occupy; seize ②rely on; depend on ③ according to ④ evidence; certificate  
 据报道 jù'bào'dào  
 it is reported that  
 据说 jù'shuō  
 it is said that; they say  
 据悉 jù'xī  
 it is reported that

## 聚 jù

assemble; gather; get together  
 聚光灯 jù'guāng'dēng  
 spotlight  
 聚会 jù'huì  
 meet; party  
 聚拢 jù'lǒng  
 gather together

## 举 jǔ

① lift; raise; hold up ② act; deed; move ③ start ④ elect; choose ⑤cite; enumerate ⑥whole; entire  
 举办 jǔ'bàn  
 hold; conduct; run  
 举起 jǔ'qǐ  
 lift; raise; hold up  
 举重 jǔ'zhòng  
 weight lifting

## 局 jú

①chessboard ②game; set; innings ③situation; state of affairs ④limit ⑤office; bureau; shop  
 局部 jú'bù  
 part; partial  
 局外人 jú'wài'rén  
 outsider  
 局长 jú'zhǎng  
 bureau head

## 俱 jù

all; complete  
 俱乐部 jù'lè'bù  
 club  
 俱全 jù'quán  
 complete in all varieties

## 惧 jù

fear; dread  
 惧怕 jù'pà  
 fear; dread  
 惧色 jù'sè  
 a look of fear

## 具 jù

①utensil; tool; implement ②possess; have  
 具备 jù'bèi  
 have; possess  
 具体 jù'tǐ  
 concrete; specific  
 具有 jù'yǒu  
 have; be provided with

## 距 jù

①distance ②be apart from; be at a distance from  
 距离 jù'lí  
 distance; space; gap

## 拒 jù

①resist; repel ②refuse; reject  
 拒捕 jù'bǔ  
 resist arrest  
 拒付 jù'fù  
 refuse payment  
 拒收 jù'shōu  
 reject

## 觉 jué

①sense ②wake (up); awake  
 觉察 jué'chá  
 sense; read; find  
 觉得 jué'de  
 feel; think  
 觉醒 jué'xǐng  
 awaken; awake; rouse

## 绢 juàn

thin, tough silk  
 绢花 juàn'huā  
 silk flower  
 绢丝 juàn'sī  
 spun silk

## 卷 juǎn

①roll up ②sweep off; carry a-long ③roll ④spool; reel  
 卷笔刀 juǎn'bǐ'dāo  
 pencil sharpener  
 卷心菜 juǎn'xīn'cài  
 cabbage  
 卷烟 juǎn'yān  
 cigarette; cigar

## 剧 jù

①theatrical work; drama; play; opera ②acute; severe; intense  
 剧本 jù'běn  
 play; drama; script  
 剧场 jù'chǎng  
 theatre  
 剧痛 jù'tòng  
 a severe pain

## 句 jù

sentence  
 句号 jù'hào  
 full stop; period  
 句型 jù'xíng  
 sentence pattern  
 句子 jù'zi  
 sentence

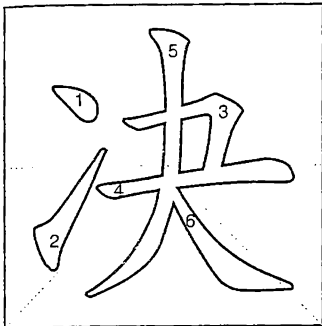

决 jué 826

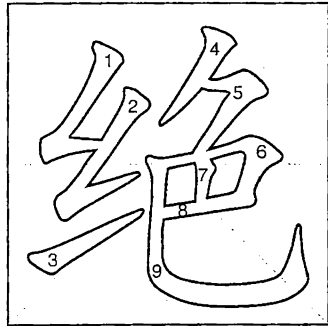

绝 jué 827

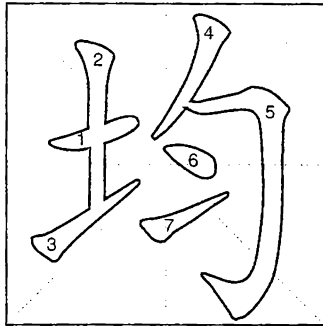

均 jūn 828

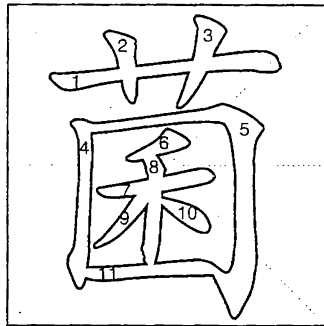

菌 jūn 829

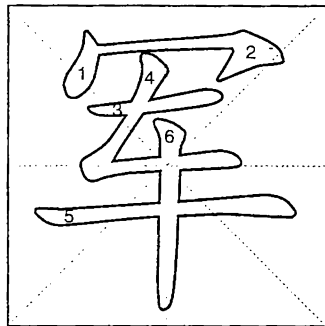

军 jūn 830

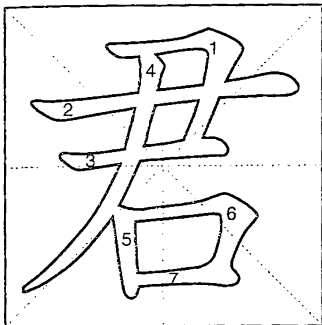

君 jūn 831

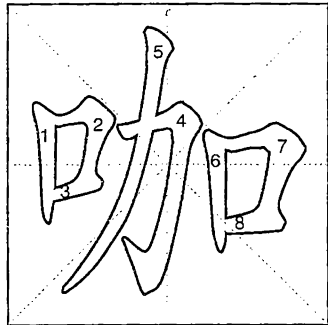

咖 kā 832

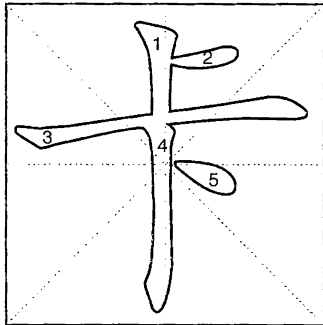

卡 kǎ 833

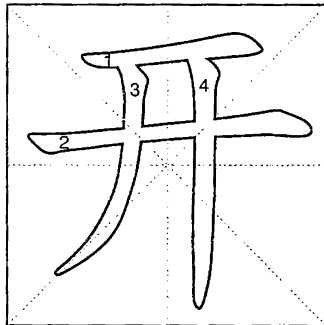

开 kāi 834

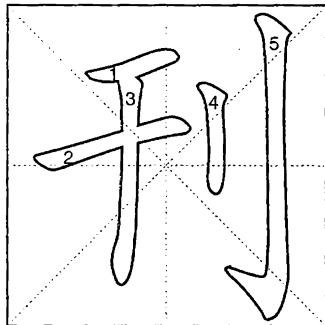

刊 kān 835



看 kàn 836

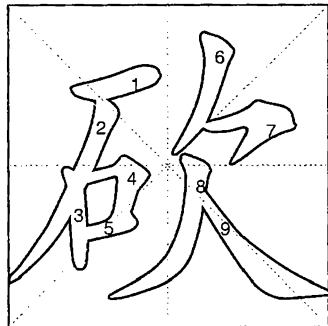

砍 kǎn 837



看 kàn 838

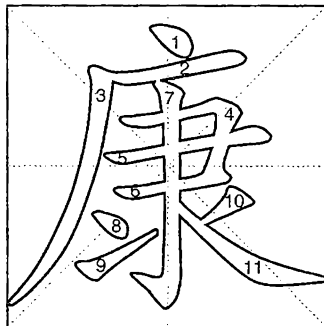

康 kāng 839

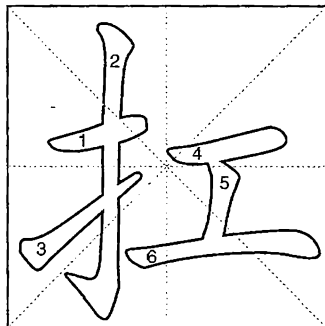

扛 kāng 840

### 军 jūn

①armed forces ②army  
军号 jūn'hào  
bugle  
军舰 jūn'jiàn  
warship; naval vessel  
军旗 jūn'qí  
army flag

### 菌 jūn

①fungus ②bacterium  
细菌 xì'jūn  
germ; bacterium

### 均 jūn

①equal; even ②without exception; all  
均分 jūn'fēn  
share out equally  
均势 jūn'shì  
balance of power  
均匀 jūn'yún  
even; well-distributed

### 绝 jué

①cut off; sever ②exhausted; used up; finished ③desperate; hopeless  
④unique; superb; matchless  
绝版 jué'bǎn  
out of print  
绝唱 jué'chàng  
last song  
绝交 jué'jiāo  
break off relations

### 决 jué

①decide; determine ②definitely; certainly ③execute a person  
决策人 jué'cè'rén  
policymaker  
决口 jué'kǒu  
burst; breach; break  
决算 jué'suàn  
final accounts

### 刊 kān

①print; publish ②periodical; publication ③delete or correct  
刊登 kān'dēng  
publish  
刊物 kān'wù  
publication

### 开 kāi

①open ②make an opening; open up; reclaim ③open out; come loose ④thaw; become navigable  
⑤lift (a restriction, etc.)  
开户 kāi'hù  
open an account  
开花 kāi'huā  
blossom; bloom  
开门 kāi'mén  
open the door

### 卡 kǎ

block; check  
卡车 kǎ'chē  
lorry; truck  
卡带 kǎ'dài  
cassette  
卡片 kǎ'piàn  
card

### 咖 kā

咖啡 kā'fēi  
coffee  
咖啡馆 kā'fēi'guǎn  
café; coffee bar  
咖啡因 kā'fēi'yīn  
caffeine

### 君 jūn

①monarch; supreme ruler  
②gentleman; Mr  
君王 jūn'wáng  
king; lord  
君主 jūn'zhǔ  
monarch; sovereign  
君子 jūn'zi  
gentleman

### 扛 kāng

carry on the shoulder  
扛枪 kāng'qiāng  
shoulder a gun

### 康 kāng

well-being; health  
康复 kāng'fù  
restored to health  
康复中心 kāng'fù'zhōng'xīn  
rehabilitation center  
康乐 kāng'lè  
peace and happiness

### 看 kàn

①see; look at; watch ②read  
③think; consider ④look upon; regard ⑤treat (a patient or an illness)  
看报 kàn'bào  
read newspapers  
看病 kàn'bìng  
see or consult a doctor  
看法 kàn'fǎ  
view

### 砍 kǎn

①cut; chop; hack ②throw sth.at  
砍刀 kǎn'dāo  
chopper  
砍伐 kǎn'fá  
fell (trees)  
砍头 kǎn'tóu  
behead

### 看 kān

①look after; take care of; tend  
②keep under surveillance; keep an eye on sb.  
看管 kān'guǎn  
look after; watch; guard  
看护 kān'hù  
nurse (the sick)  
看守 kān'shǒu  
watch; guard; warder

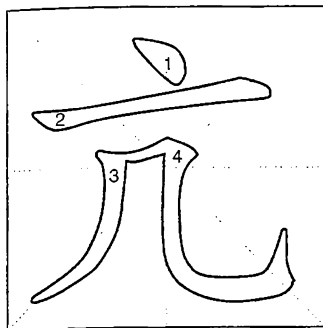

亢 kàng 841

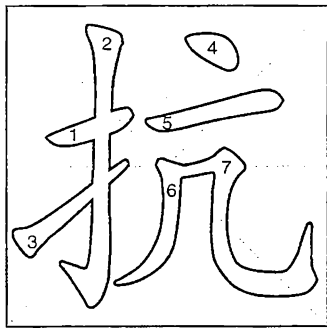

抗 kàng 842

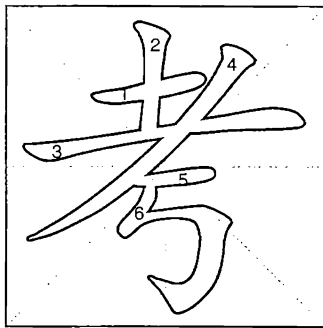

考 kǎo 843

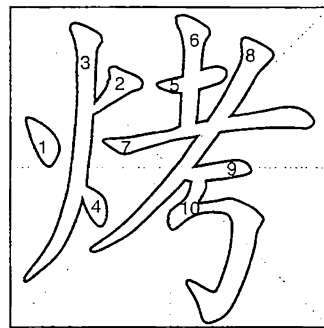

烤 kǎo 844

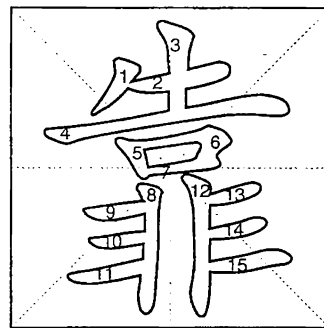

靠 kào 845

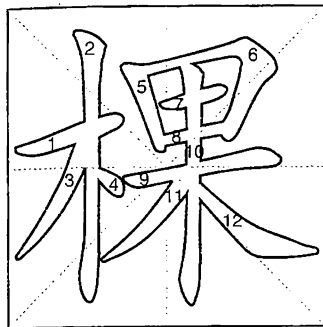

棵 kē 846

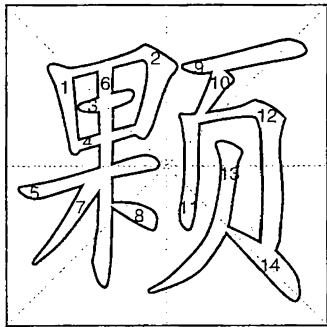

颗 kē 847



科 kē 848

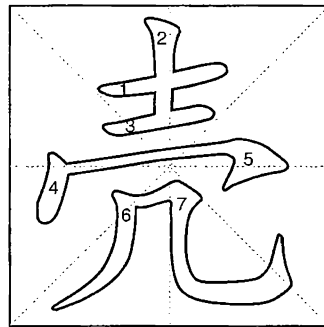

壳 ké 849

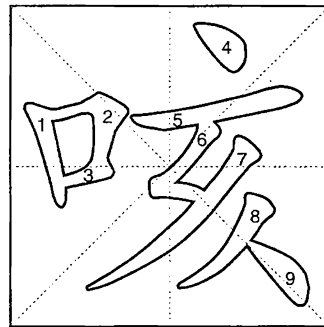

咳 ké 850

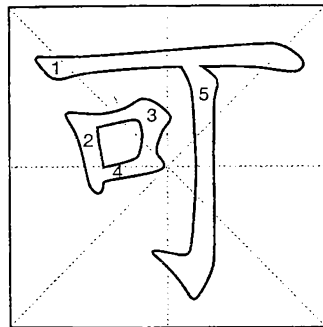

可 kě 851

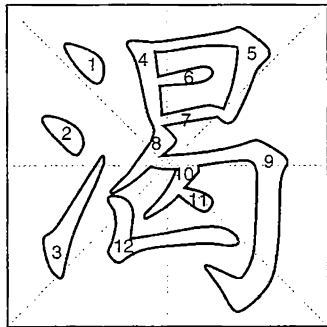

渴 kě 852

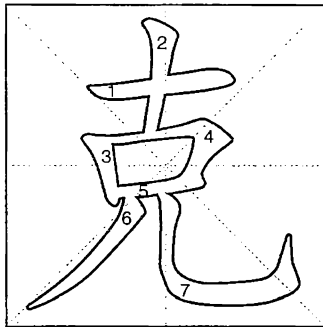

克 kè 853

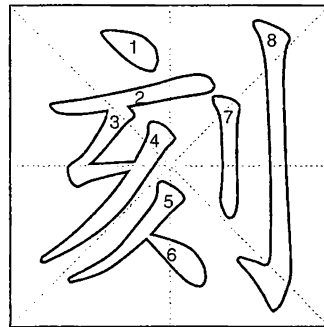

刻 kè 854

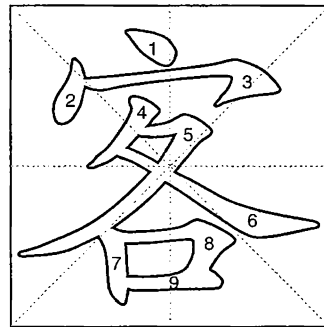

客 kè 855

### 靠 kào

①lean on ②keep to; get near; come up to ③rely on ④trust  
 靠岸 kào'àn  
 pull in to shore  
 靠近 kào'jìn  
 near; close to; by  
 靠椅 kào'yǐ  
 armchair

### 烤 kǎo

①bake; roast; toast ②scorching  
 烤炉 kǎo'lú  
 oven  
 烤面包 kǎo'miàn'bāo  
 toast  
 烤肉 kǎo'ròu  
 roast meat; roast

### 考 kǎo

①give or take an examination, test or quiz ②check; inspect  
 ③study; investigate; verify  
 考古 kǎo'gǔ  
 archaeology  
 考卷 kǎo'juǎn  
 examination paper  
 考试 kǎo'shì  
 examination; test

### 抗 kàng

①resist; combat; fight  
 ②refuse; defy  
 抗旱 kàng'hàn  
 combat a drought  
 抗日战争 kàng'rì'zhàn'zhēng  
 The War of Resistance Against Japan

### 亢 kàng

①high; haughty ②excessive extreme  
 亢奋 kàng'fèn  
 stimulated; excited  
 亢进(医) kàng'jìn(yī)  
 hyperfunction

### 咳 ké

cough  
 咳嗽 ké'sou  
 cough  
 咳嗽糖浆 ké'sòu'táng'jiāng  
 cough syrup  
 咳痰 ké'tán  
 expectoration

### 壳 ké

①shell ②housing; casing; case  
 蛋壳 dàn'ké  
 eggshell

### 科 kē

①a branch of academic or vocational study ②section  
 ③family ④pass a sentence  
 科幻 kē'huàn  
 scientific fiction  
 科技 kē'jì  
 science and technology  
 科学家 kē'xué'jiā  
 scientist

### 颗 kē

颗粒 kē'lì  
 pellet; grain

### 棵 kē

两棵树 liǎng'kē'shù  
 two trees

### 客 kè

①visitor; guest ②traveller; passenger ③customer ④settle or live in a strange place  
 客店 kè'diàn  
 inn  
 客户 kè'hù  
 client; customer  
 客人 kè'rén  
 visitor; guest

### 刻 kè

①carve; engrave; cut ②a quarter (of an hour) ③moment ④cutting; penetrating  
 刻板 kè'bǎn  
 cut blocks for printing; inflexible  
 刻苦 kè'kǔ  
 assiduous; hardworking  
 刻字 kè'zì  
 carve characters on a seal

### 克 kè

①can; be able to ②restrain  
 ③overcome; subdue; capture (a city, etc.) ④gram  
 克服 kè'fú  
 surmount; overcome  
 克拉 kè'lā  
 carat  
 克隆(遗传) kè'lóng(yí'chuán)  
 clone

### 渴 kě

①thirsty ②yearningly  
 渴求 kě'qiú  
 ask earnestly  
 渴望 kě'wàng  
 thirst for; long for

### 可 kě

①approve ②can; may  
 ③need (doing); be worth (doing)  
 ④fit; suit ⑤but; yet  
 可观 kě'guān  
 considerable; impressive  
 可卡因 kě'kǎ'yīn  
 cocaine  
 可可 kě'kē  
 cocoa



课 kè 856

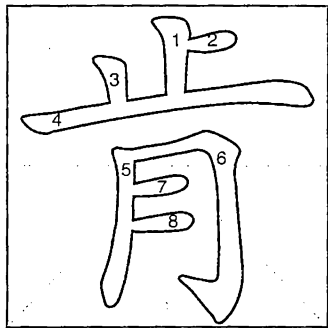

肯 kěn 857

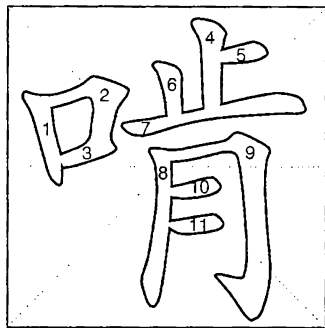

啃 kěn 858

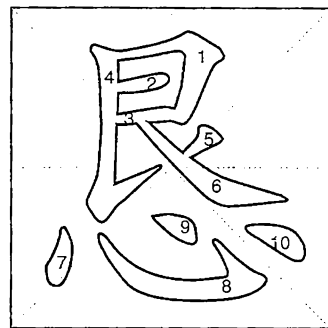

恳 kěn 859

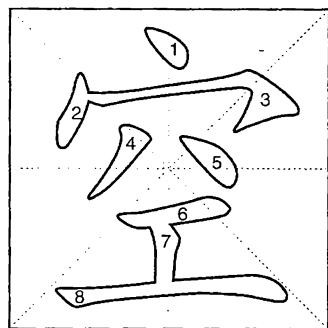

空 kōng 860

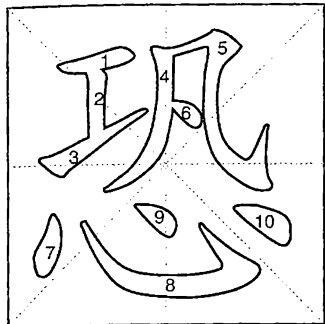

恐 kǒng 861

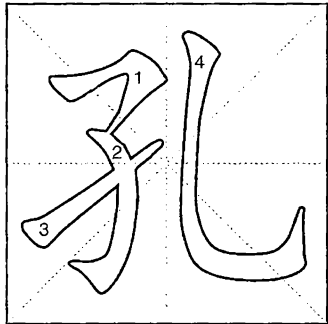

孔 kǒng 862

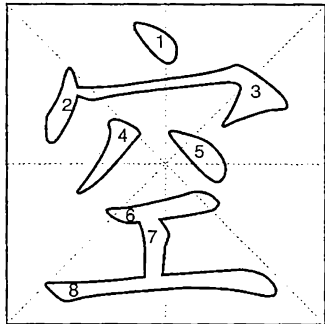

空 kòng 863

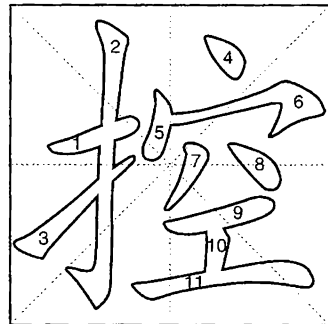

控 kòng 864

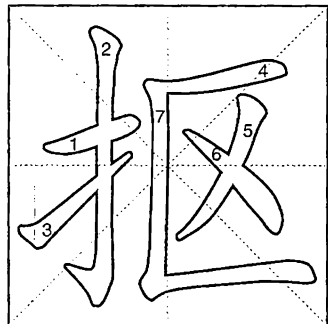

枢 kōu 865

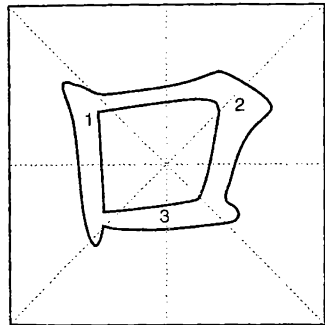

口 kǒu 866

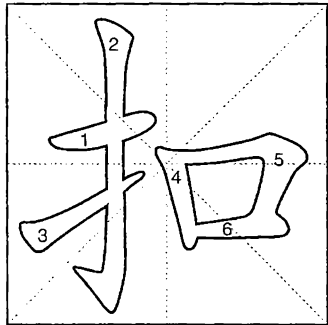

扣 kòu 867

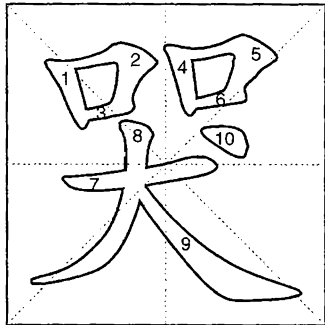

哭 kū 868

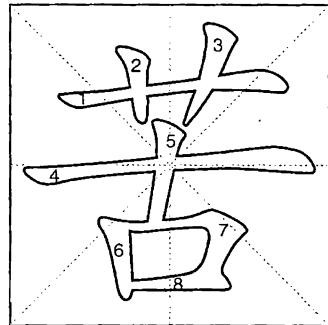

苦 kǔ 869

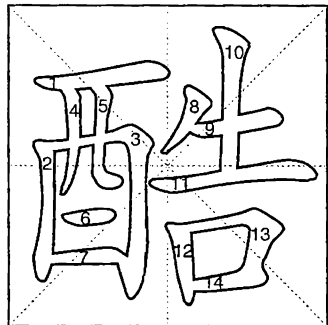

酷 kù 870



### 空 kōng

- ①empty; hollow; void ②sky; air  
 ③for nothing; in vain  
 空气 kōng'qì  
 air; atmosphere  
 空心 kōng'xīn  
 hollow  
 空邮 kōng'yóu  
 airmail

### 恳 kěn

- ①sincerely ②request  
 恳切 kěn'qiè  
 earnest; sincere  
 恳请 kěn'qǐng  
 earnestly request  
 恳求 kěn'qiú  
 implore; entreat

### 啃 kěn

- gnaw; nibble  
 啃书本 kěn'shū'běn  
 delve into books

### 肯 kěn

- ①agree; consent ②be willing to;  
 be ready to  
 肯定 kěn'dìng  
 affirm; confirm; approve

### 课 kè

- ①subject; course ②class  
 ③lesson ④tax ⑤levy (a tax on sb.)  
 课本 kè'běn  
 textbook  
 课文 kè'wén  
 text  
 课余 kè'yú  
 after school; after class

### 抠 kōu

- ①dig; dig out; scratch  
 ②carve; cut ③delve into  
 ④stingy  
 抠门儿 kōu'mén'er  
 stingy; miserly

### 控 kòng

- ①accuse ②control; dominate  
 遥~ (yáo~) remote control  
 控告 kòng'gào  
 charge; accuse; complain  
 控诉 kòng'sù  
 accuse; denounce  
 控制 kòng'zhì  
 control; dominate

### 空 kòng

- ①leave empty or blank ②unoccupied;  
 vacant ③empty space  
 ④free time; spare time  
 空白 kòng'bái  
 blank space  
 空白票据 kòng'bái'piào'jù  
 blank bill

### 孔 kǒng

- hole; opening; aperture  
 孔庙 kǒng'miào  
 Confucian temple  
 孔雀 kǒng'què  
 peacock  
 孔眼 kǒng'yǎn  
 hole

### 恐 kǒng

- ①fear; dread ②terrify; intimidate  
 date  
 恐怖分子 kǒng'bù'fēn'zǐ  
 terrorist  
 恐吓 kǒng'hè  
 threaten; intimidate  
 恐龙 kǒng'lóng  
 dinosaur

### 酷 kù

- ①cruel ②very; extremely  
 酷爱 kù'ài  
 be very fond of  
 酷暑 kù'shǔ  
 the intense heat of summer  
 酷刑 kù'xíng  
 cruel (savage) torture

### 苦 kǔ

- ①bitter ②hardship; suffering;  
 pain ③cause sb. suffering; give sb.  
 a hard time ④be troubled by  
 苦瓜 kǔ'guā  
 balsam pear  
 苦笑 kǔ'xiào  
 forced smile; wry smile  
 苦于 kǔ'yú  
 suffer from

### 哭 kū

- cry; weep  
 哭哭啼啼 kū'ku'tí'tí  
 endlessly weep  
 哭泣 kū'qì  
 cry; weep; sob  
 哭诉 kū'sù  
 complain with tears

### 扣 kòu

- ①button up; buckle ②place a  
 cup, bowl, etc. upside down ③de-  
 tain; arrest ④deduct (a part of  
 sb.'s pay, etc.)  
 扣除 kòu'chú  
 deduct  
 扣压 kòu'yā  
 withhold; pigeonhole  
 扣子 kòu'zi  
 button; buckle; knot

### 口 kǒu

- ①mouth ②opening; entrance  
 ③cut; hole ④edge (of a knife)  
 口岸 kǒu'àn  
 port  
 口渴 kǒu'kě  
 thirsty



庠 kù 871



裤 kù 872

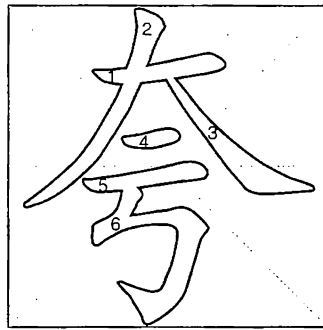

夸 kuā 873

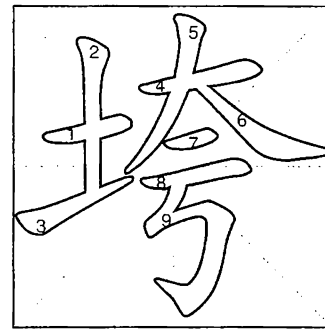

垮 kuǎ 874

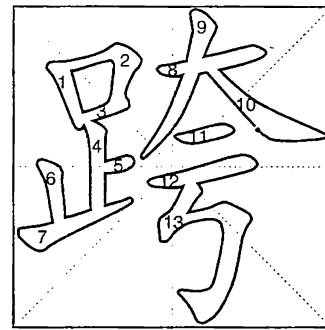

跨 kuà 875

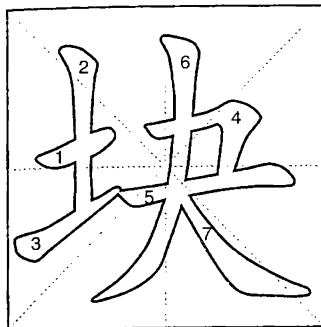

块 kuài 876

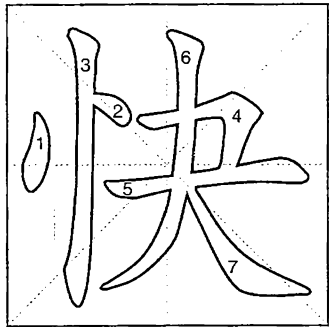

快 kuài 877



筷 kuài 878

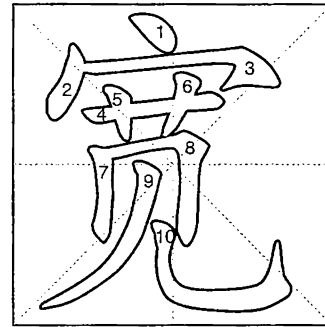

宽 kuān 879

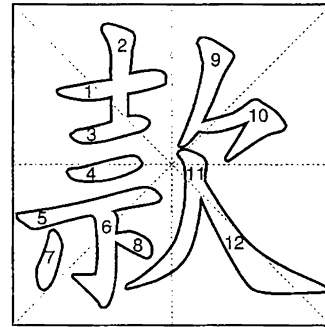

款 kuǎn 880

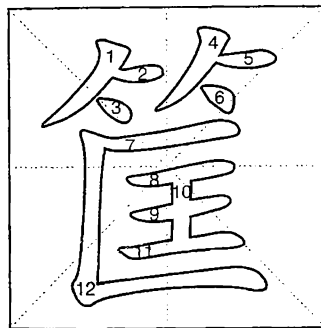

筐 kuāng 881

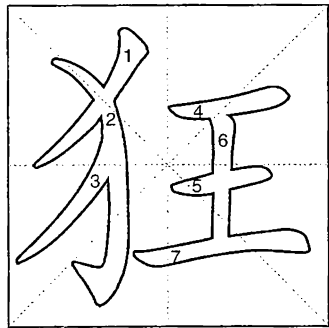

狂 kuáng 882

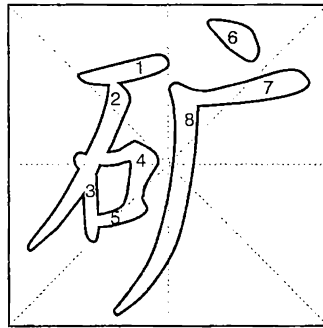

矿 kuàng 883

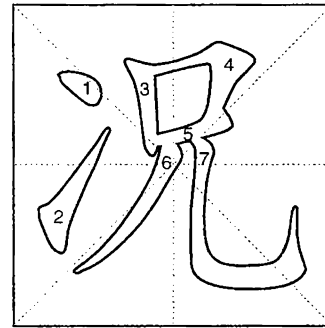

况 kuàng 884

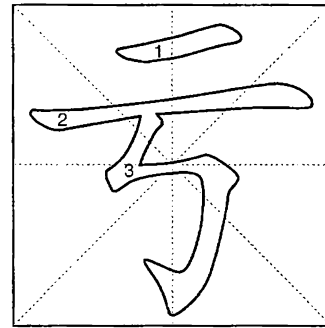

亏 kuī 885

### 跨 kuà

①step; stride ②bestride; straddle ③cut across  
 跨国 kuà'guó  
 transnational  
 跨年度 kuà'nián'dù  
 go beyond the year  
 跨越 kuà'yue  
 stride across; leap over

### 垮 kuǎ

collapse; fall; break down  
 垮塌 kuǎ'tā  
 collapse; break down  
 垮台 kuǎ'tái  
 collapse; fall from power

### 夸 kuā

①exaggerate; overstate; boast  
 ②praise  
 夸大 kuā'dà  
 exaggerate; overstate  
 夸奖 kuā'jiǎng  
 praise; commend  
 夸张 kuā'zhāng  
 exaggerate; overstate

### 裤 kù

trousers; pants  
 裤带 kù'dài  
 waist belt  
 裤腰 kù'yāo  
 waist of trousers  
 裤子 kù'zi  
 trousers

### 库 kù

warehouse; storehouse  
 库存(量) kù'cún(liàng)  
 stock; storage  
 库房 kù'fáng  
 storehouse; storeroom  
 库容(水) kù'róng(shuǐ)  
 storage capacity

### 款 kuǎn

①receive with hospitality; entertain ②section of an article; paragraph ③fund  
 款待 kuǎn'dài  
 treat; treat cordially  
 款式 kuǎn'shì  
 style  
 款子 kuǎn'zi  
 a sum of money

### 宽 kuān

①wide; broad ②breadth ③relax; relieve ④generous; lenient  
 宽敞 kuān'chǎng  
 spacious  
 宽带 kuān'dài  
 (in analogue communication)  
 broadband  
 宽容 kuān'róng  
 forbearing; indulgent

### 筷 kuài

筷子 kuài'zi  
 chopsticks

### 快 kuài

①fast; quick; rapid ②speed  
 ③hurry up; make haste ④soon;  
 before long ⑤quic-witted; ingenious  
 快餐 kuài'cān  
 quick meal; snack  
 快车 kuài'chē  
 express train or bus  
 快门 kuài'mén  
 shutter

### 块 kuài

①piece; lump; chunk ②piece; cake  
 块茎 kuài'jīng  
 stem tuber; root tuber  
 块煤 kuài'méi  
 lump coal; torbanite

### 亏 kuī

①lose (money, etc.); have a deficit ②deficient; short ③treat unfairly ④fortunately; luckily; thanks to  
 亏本 kuī'běn  
 lose one's capital  
 亏损 kuī'sǔn  
 loss, deficit  
 亏心 kuī'xīn  
 have a guilty conscience

### 况 kuàng

①condition; situation ②compare  
 况且 kuàng'qiě  
 moreover

### 矿 kuàng

①mineral deposit ②ore ③mine  
 铁矿 tiě'kuàng  
 iron ore; iron mine

### 狂 kuáng

①mad; crazy ②violent ③wild; unrestrained ④arrogant; overbearing  
 狂风 kuáng'fēng  
 whole gale; wind  
 狂风暴雨 kuáng'fēng'bào'yǔ  
 storm; tempest  
 狂欢 kuáng'huān  
 revelry; carnival

### 筐 kuāng

basket  
 筐子 kuāng'zi  
 small basket; crate

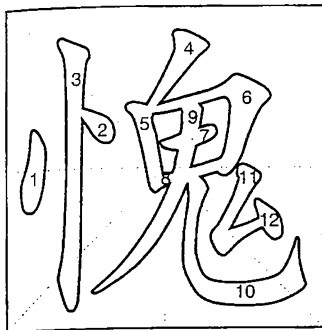

愧 kuì 886

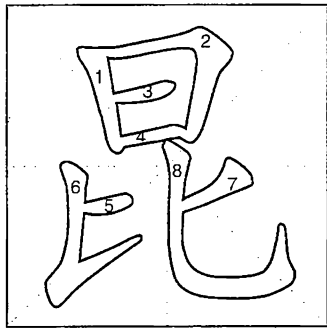

昆 kūn 887

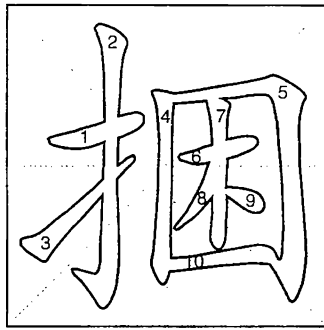

捆 kǔn 888

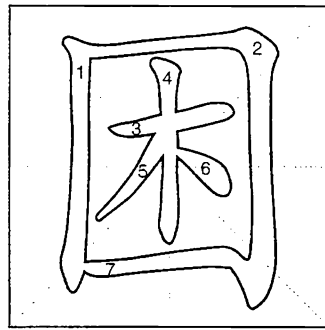

困 kùn 889

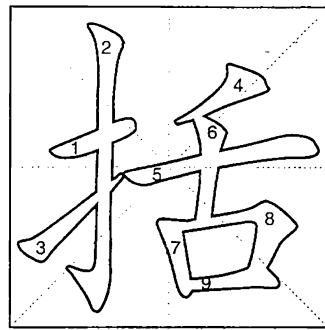

括 kuò 890

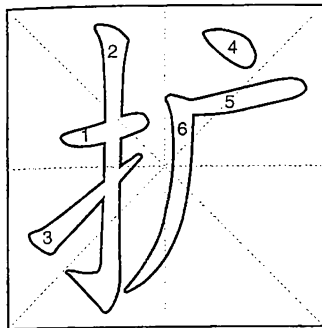

扩 kuò 891

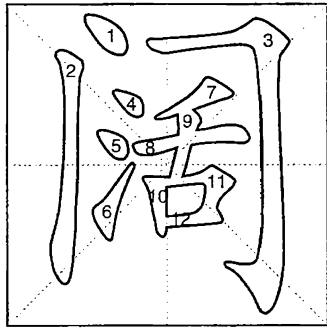

阔 kuò 892

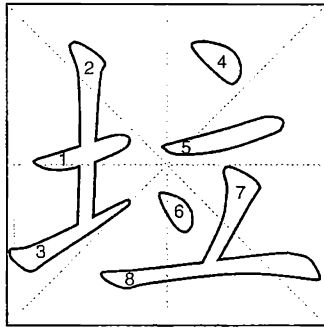

垃 lā 893

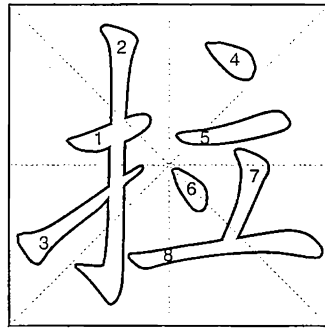

拉 lā 894

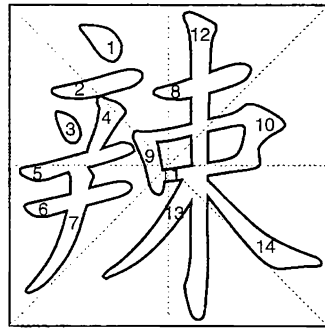

辣 là 895

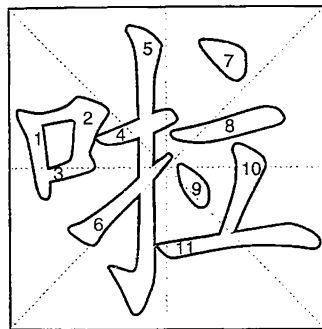

啦 la 896

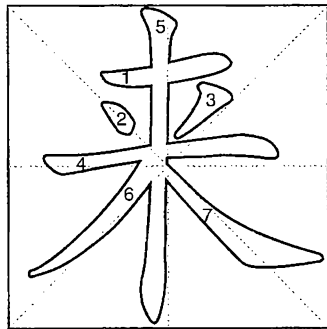

来 lái 897

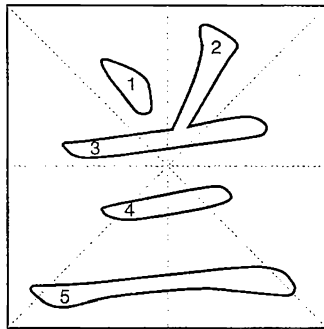

兰 lán 898

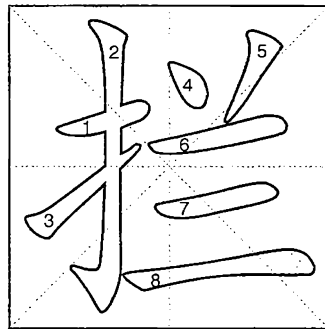

拦 lán 899

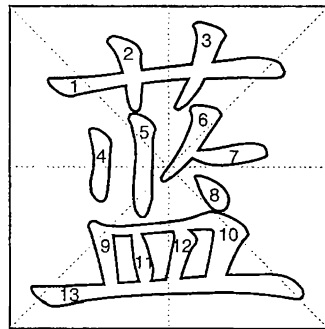

蓝 lán 900

### 括 kuò

① draw together (muscles, etc.); contract ② include  
括号 kuò'hào  
brackets

### 困 kùn

① be stranded; be hard pressed  
② surround; pin down ③ tired  
④ sleepy  
困乏 kùn'fá  
tired; fatigued  
困境 kùn'jìng  
difficult position  
困难 kùn'nán  
difficulty

### 捆 kǔn

① tie; bind; bundle up ② bundle  
捆绑 kǔn'bǎng  
bind; tie up  
捆扎 kǔn'zā  
tie up; bundle up

### 昆 kūn

elder brother; offspring  
昆虫 kūn'chóng  
insect

### 愧 kuì

ashamed; conscience-stricken  
愧心 kuì'xīn  
ashamed at heart

### 辣 là

① peppery; hot ② (of smell or taste) burn; bite; sting ③ vicious; ruthless  
辣椒 là'jiāo  
hot pepper; chili  
辣椒油 là'jiāo'yóu  
chili oil  
辣手 là'shǒu  
ruthless method; thorny

### 拉 lā

① pull; draw; tug; drag ② transport by vehicle; haul ③ move (troops to a place) ④ play  
拉肚子 là'dù'zi  
suffer from diarrhea  
拉开 lā'kāi  
pull open; draw back  
拉链 lā'liàn  
zip-fastener; zipper

### 垃 lā

垃圾 lā'jī  
rubbish; garbage; refuse  
垃圾股 lā'jī'gǔ  
junk bond  
垃圾箱 lā'jī'xiāng  
dustbin; garbage can

### 阔 kuò

① wide; broad; vast  
② wealthy; rich  
阔老 kuò'lǎo  
rich man  
阔气 kuò'qì  
luxurious; extravagant  
阔人 kuò'rén  
rich man

### 扩 kuò

expand; enlarge; extend  
扩大 kuò'dà  
enlarge; extend  
扩音器 kuò'yīn'qì  
megaphone  
扩印 kuò'yìn  
enlarge; enlargement

### 蓝 lán

① blue ② indigo plant  
蓝宝石 lán'bǎo'shí  
sapphire  
蓝皮书 lán'pí'shū  
blue book  
蓝色 lán'sè  
blue

### 拦 lán

bar; block; hold back  
拦击 lán'jī  
intercept and attack  
拦网〈体〉(排球)  
lán'wǎng(tǐ) (pái'qiú)  
block  
拦住 lán'zhù  
hold up; keep away

### 兰 lán

orchid  
兰花 lán'huā  
cymbidium; orchid

### 来 lái

① come; arrive ② crop up; take place ③ future; coming; next  
④ about; around  
来宾 lái'bīn  
guest; visitor  
来生 lái'shēng  
next life  
来文 lái'wén  
document received

### 啦 la

他们真来啦? tā'men'zhēn'lái'la?  
Have they really come?

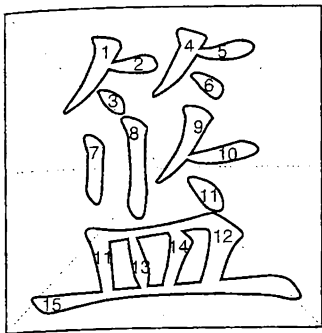

篮 lán 901

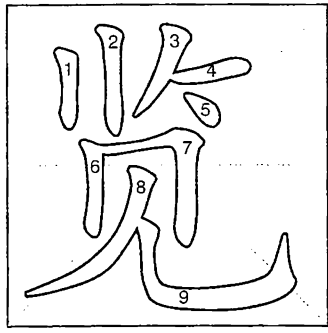

览 lǎn 902



懒 lǎn 903

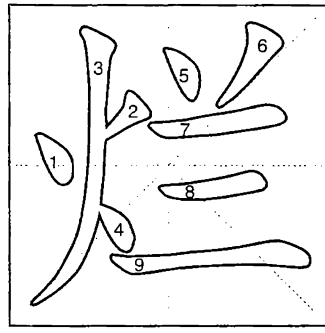

烂 làn 904

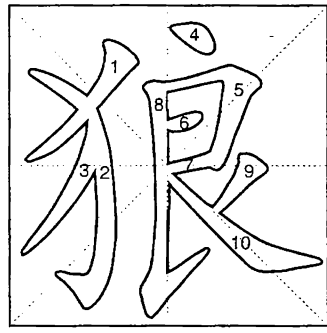

狼 láng 905

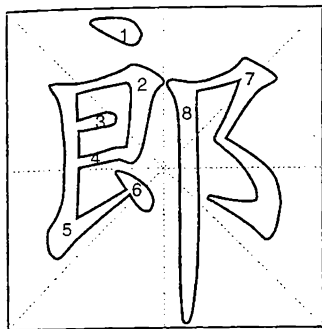

郎 láng 906

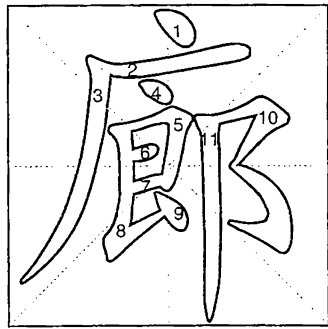

廊 láng 907

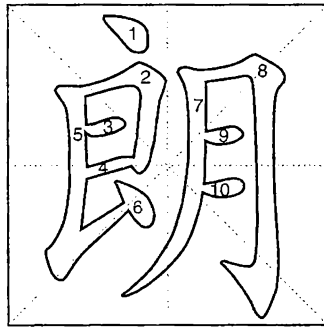

朗 lǎng 908

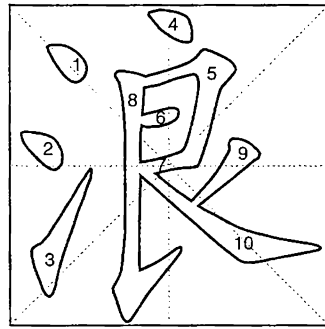

浪 làng 909

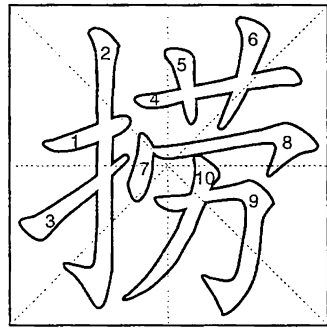

捞 lāo 910

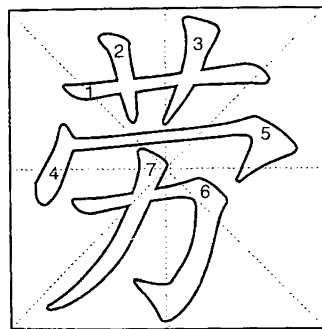

劳 láo 911

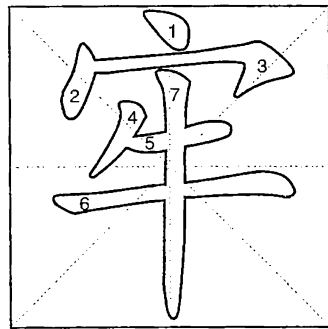

牢 láo 912

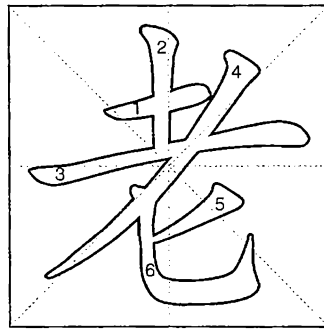

老 lǎo 913

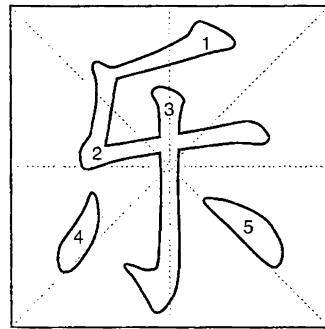

乐 lè 914

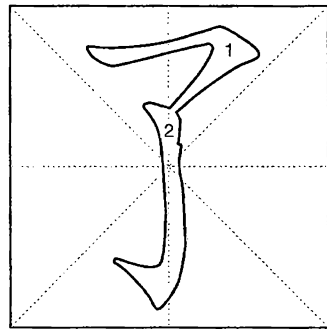

了 le 915

### 狼 láng

wolf  
 狼狗 láng'gǒu  
 wolfhound  
 狼群 láng'qún  
 wolf pack  
 狼子野心 láng'zǐ'yě'xīn  
 wolfish ambition

### 烂 làn

①mashed; pappy  
 ②rot; fester ③worn-out  
 ④messy  
 烂漫 làn'màn  
 bright-coloured  
 烂泥 làn'ní  
 mud; slush  
 烂醉 làn'zuì  
 dead drunk

### 懒 lǎn

①lazy; indolent; slothful  
 ②languid  
 懒惰 lǎn'duò  
 lazy  
 懒汉 lǎn'hàn  
 idler; sluggard  
 懒洋洋 lǎn'yáng'yáng  
 listless; languid

### 览 lǎn

look at; view; read  
 阅览室 yuè'lǎn'shì  
 reading room

### 篮 lán

①basket ②goal  
 篮球 lán'qiú  
 basketball  
 篮球队 lán'qiú'duì  
 basketball team  
 篮子 lán'zi  
 basket

### 捞 lāo

①drag for; scoop up from the water ②get by improper means  
 捞取 lāo'qǔ  
 fish for; gain  
 捞网 lāo'wǎng  
 scoop net  
 捞鱼 lāo'yú  
 net fish; catch fish

### 浪 làng

①wave; billow ②unrestrained  
 浪花 làng'huā  
 spray; spindrift  
 浪漫 làng'màn  
 romantic  
 浪头 làng'tou  
 wave; trend

### 朗 lǎng

①light; bright ②loud and clear  
 朗读 lǎng'dú  
 read aloud  
 朗诵 lǎng'sòng  
 recite; declaim

### 廊 láng

porch; corridor; veranda  
 走廊 zǒu'láng  
 corridor; passage

### 郎 láng

郎舅 láng'jiù  
 a man and his wife's brother

### 了 le

饿了 è'le  
 be hungry  
 吃了 chī'le  
 have (has) eaten

### 乐 lè

①happy; cheerful; joyful ②be glad to; find pleasure in; enjoy  
 ③laugh; be amused  
 乐观 lè'guān  
 optimistic; hopeful  
 乐意 lè'yì  
 be willing to; happy  
 乐园 lè'yuán  
 paradise

### 老 lǎo

①old; aged ②old people ③of long standing; old ④outdated ⑤overgrown  
 老板 lǎo'bǎn  
 boss; proprietor  
 老虎 lǎo'hǔ  
 tiger  
 老年 lǎo'nián  
 old age

### 牢 láo

①prison; jail ②firm; fast; durable  
 牢房 láo'fáng  
 cell; ward  
 牢固 láo'gù  
 firm; secure  
 牢记 láo'jì  
 keep firmly in mind

### 劳 láo

①work; labor ②put sb. to the trouble of ③fatigue ④meritorious deed; service  
 劳保 láo'bǎo  
 labor insurance  
 劳工 láo'gōng  
 laborer; worker  
 劳务 láo'wù  
 labor services

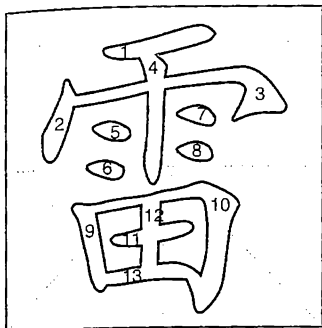

雷 léi 916



累 lěi 917

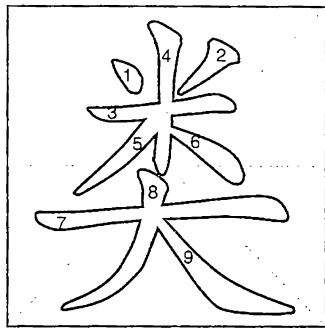

类 lèi 918

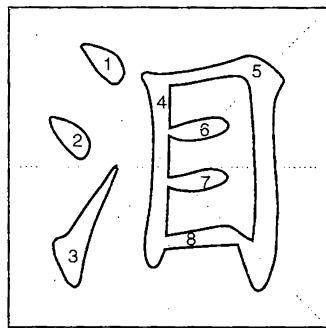

泪 lèi 919

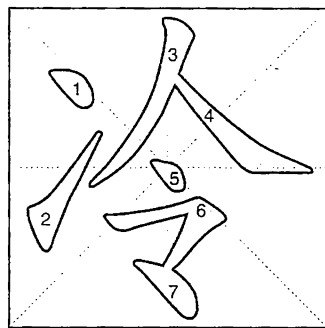

冷 lěng 920

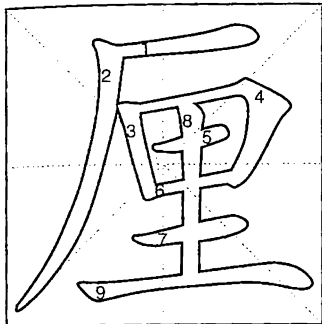

厘 lí 921

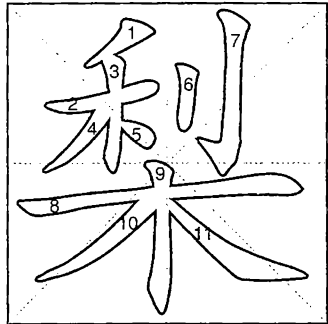

梨 lí 922

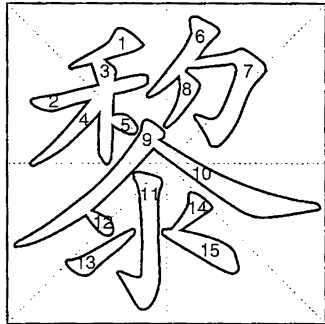

黎 lí 923

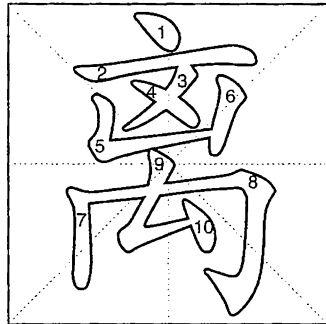

离 lí 924

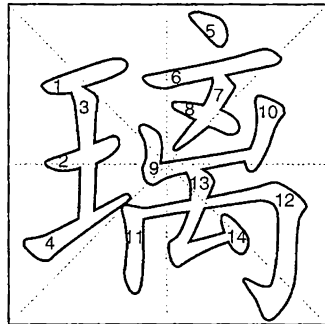

璃 lí 925

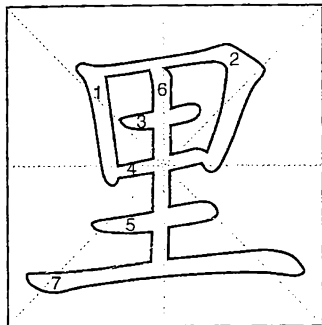

里 lǐ 926

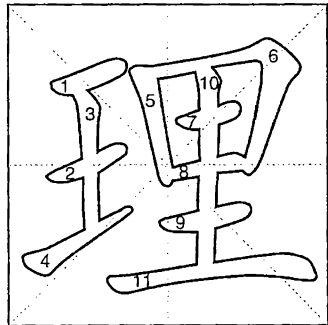

理 lǐ 927

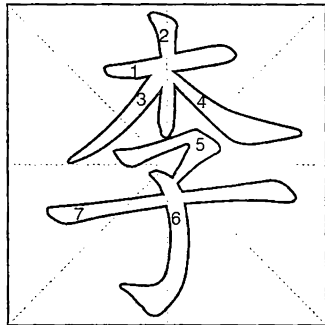

李 lǐ 928

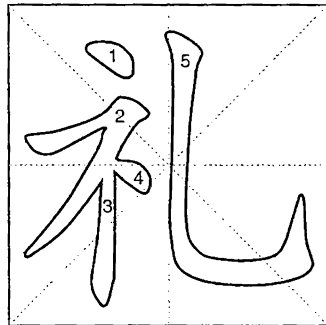

礼 lǐ 929

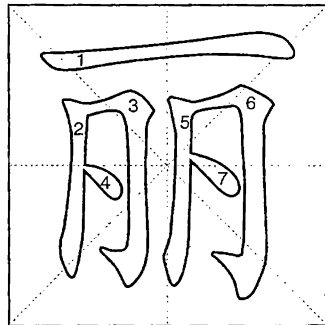

丽 lì 930



### 冷 lěng

- ①cold ②cold in manner; frosty  
③shot from hiding  
冷汗 lěng'hàn  
cold sweat  
冷水浴 lěng'shuǐ'yù  
cold bath  
冷战 lěng'zhàn  
cold war

### 泪 lèi

- tear  
泪水 lèi'shuǐ  
tear; teardrop  
泪眼 lèi'yǎn  
tearful eyes  
泪珠 lèi'zhū  
teardrop

### 类 lèi

- ①kind; type; class; category  
②resemble; be similar to  
类似 lèi'sì  
similar; analogous  
类推 lèi'tuī  
reason by analogy  
类型 lèi'xíng  
type

### 累 lěi

- ①pile up; accumulate ②contin-  
ous; repeated; running ③involve  
累次 lèi'cì  
repeatedly; several times  
累犯 lèi'fàn  
recidivism; recidivist  
累计 lèi'jì  
add up; grand total

### 雷 léi

- ①thunder ②mine  
雷达 léi'dá  
radar  
雷电 léi'diàn  
thunder and lightning  
雷声 léi'shēng  
thunderclap; thunder

### 璃 lí

- 玻璃 bō'li  
glass

### 离 lí

- ①leave; part from ②off; away;  
from ③without; independent of  
离岸价 lí'àn'jià  
free on board (FOB)  
离任 lí'rèn  
leave one's post  
离异 lí'yì  
separate; divorce

### 黎 lí

- multitude; host  
黎民 lí'mín  
the common people  
黎明 lí'míng  
dawn; daybreak

### 梨 lí

- pear  
梨花 lí'huā  
pear flower  
梨树 lí'shù  
pear tree  
梨园 lí'yuán  
the operatic circle

### 厘 lí

- ①a unit of length, weight or area  
②one thousandth of a yuan  
③a unit of interest rate  
④centi-  
⑤a very small amount  
厘米 lí'mǐ  
centimeter

### 丽 lì

- beautiful  
丽人 lì'rén  
a beauty

### 礼 lì

- ①ceremony; rite ②courtesy;  
manners ③gift; present  
礼花 lì'huā  
fireworks display  
礼节 lì'jié  
ceremony; courtesy  
礼品 lì'pǐn  
gift; present

### 李 lǐ

- plum  
李子 lì'zi  
plum

### 理 lǐ

- ①texture; grain (in wood, skin,  
etc.) ②reason; logic; truth ③natu-  
ral science, esp. physics ④man-  
age; run  
理发 lì'fà  
haircut; hairdressing  
理论 lì'lùn  
theory  
理由 lì'yóu  
reason; ground

### 里 lǐ

- ①lining; inside ②inner ③natu-  
rive place ④li, a Chinese unit of  
length(=1/2 kilometre) ⑤in; inside  
里边 lì'biān  
inside; in; within  
里里外外 lì'lǐ'wài'wài  
inside and outside  
里屋 lì'wū  
inner room

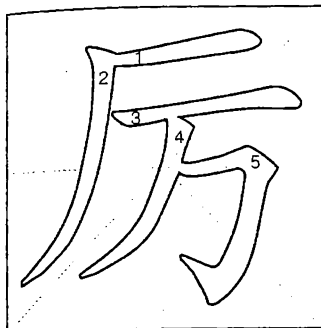

厉 lì 931

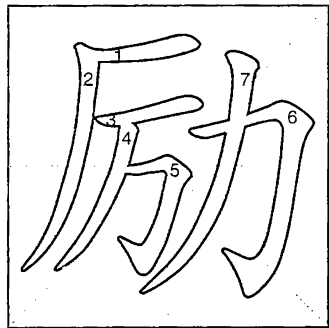

励 lì 932

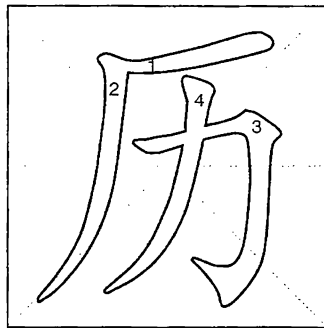

历 lì 933

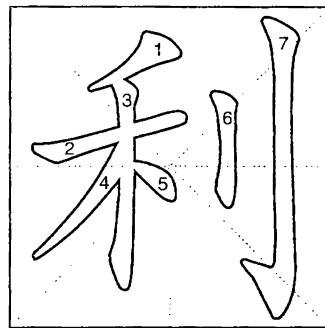

利 lì 934

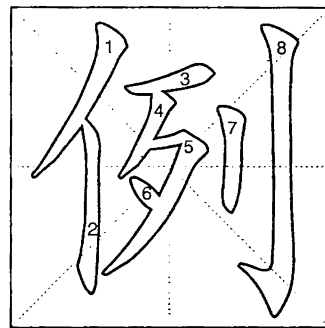

例 lì 935

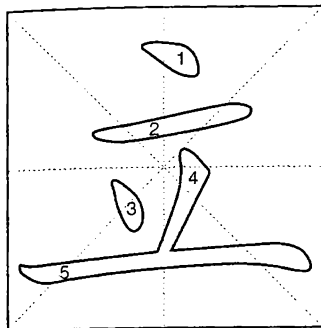

立 lì 936

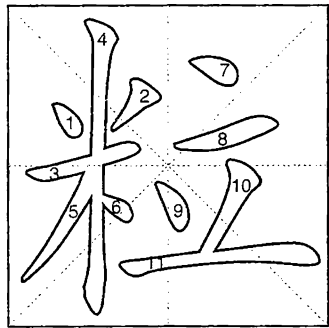

粒 lì 937

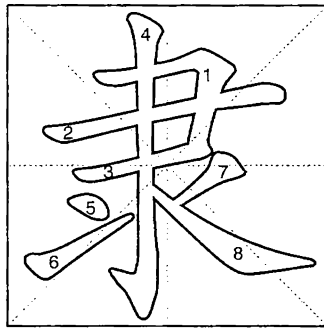

隶 lì 938

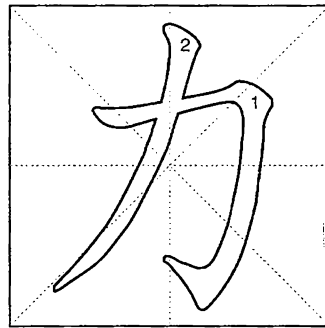

力 lì 939

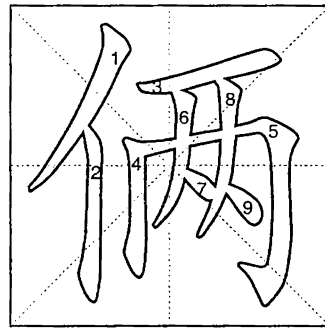

俩 liǎ 940

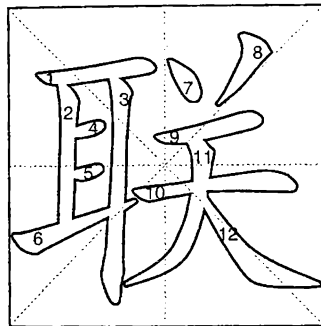

联 lián 941

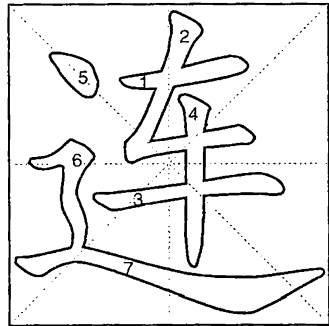

连 lián 942

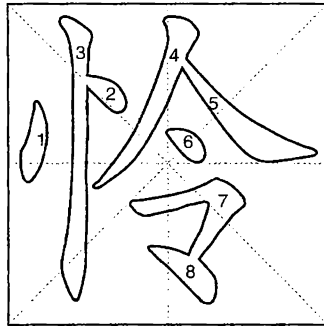

怜 lián 943

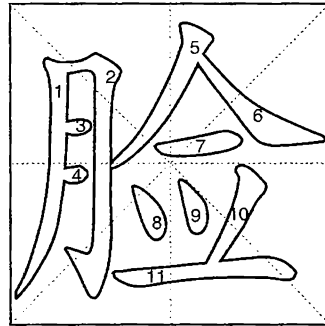

脸 liǎn 944

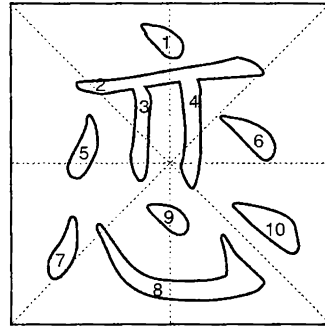

恋 liàn 945

### 例 lì

① example; instance ② precedent ③ case (of illness, etc.); ④ rule; regulation ⑤ regular; routine  
 例会 lì'huì  
 regular meeting  
 例句 lì'jù  
 example; model sentence  
 例如 lì'rú  
 for instance (example)

### 利 lì

① sharp ② favourable ③ advantage; benefit ④ profit; interest  
 ⑤ do good to; benefit  
 利率 lì'lǜ  
 rate of interest  
 利益 lì'yì  
 benefit; profit; interest  
 利用 lì'yòng  
 use; utilize; exploit

### 历 lì

① go through; undergo; experience ② all previous (occasions, sessions, etc.) ③ covering all; one by one ④ calendar  
 历程 lì'chéng  
 course  
 历代 lì'dài  
 successive dynasties  
 历史 lì'shǐ  
 history; past records

### 励 lì

encourage  
 鼓励 gǔ'li  
 urge; encourage

### 厉 lì

① strict; rigorous ② stern; severe  
 厉害 lì'hài  
 severe; sharp; fierce  
 厉行节约 lì'xíng'jié'yuē  
 practise strict economy

### 俩 liǎ

① two ② some; several

### 力 lì

① power; strength; ability ② force ③ physical strength ④ do all one can; make every effort  
 力气 lì'qì  
 physical strength  
 力学〈物〉 lì'xué〈wù〉  
 mechanics  
 力争 lì'zhēng  
 do all one can do

### 隶 lì

be subordinate to; be under  
 隶属 lì'shǔ  
 be subordinate to

### 粒 lì

grain; granule; pellet  
 粒子 lì'zǐ  
 particle

### 立 lì

① stand ② erect; set up ③ upright; erect; vertical ④ found; establish; setup ⑤ exist; live  
 立方 lì'fāng  
 cube  
 立交桥 lì'jiāo'qiáo  
 overpass  
 立体电影 lì'tǐ'diàn'yǐng  
 stereoscopic film

### 恋 liàn

① love ② long for; feel attached to  
 恋爱 liàn'ài  
 love; love affair  
 恋旧 liàn'jiù  
 yearn for the past  
 恋人 liàn'rén  
 a sweetheart; a lover

### 脸 liǎn

① face; countenance ② front  
 脸红 liǎn'hóng  
 blush  
 脸盆 liǎn'pén  
 washbasin  
 脸谱 liǎn'pǔ  
 types of facial makeup in Beijing  
 Opera

### 怜 lián

sympathize with; pity  
 怜爱 lián'ài  
 love tenderly  
 怜悯 lián'mǐn  
 have compassion for  
 怜惜 lián'xī  
 take pity on

### 连 lián

① link; join; connect ② in succession; one after another; repeatedly ③ including ④ company ⑤ even  
 连队〈军〉 lián'duì〈jūn〉  
 company  
 连接 lián'jiē  
 join; link  
 连任 lián'rèn  
 be reelected consecutively

### 联 lián

① ally oneself with; unite; join ② couplet  
 联邦 lián'bāng  
 federation  
 联大 lián'dà  
 The United Nations General Assembly  
 联网 lián'wǎng  
 network(ing)

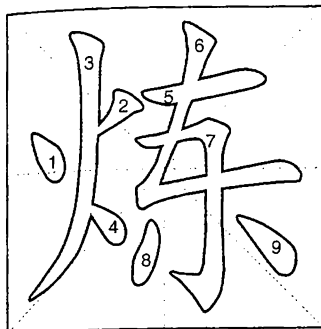

炼 liàn 946



练 liàn 947

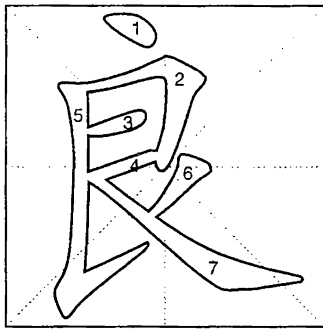

良 liáng 948

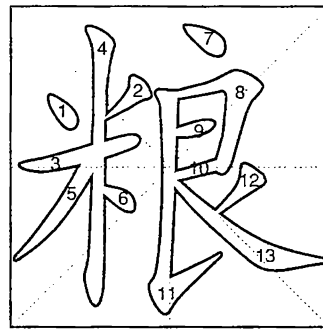

粮 liáng 949

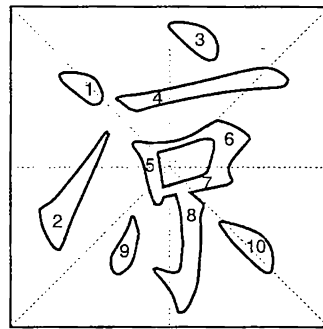

凉 liáng 950

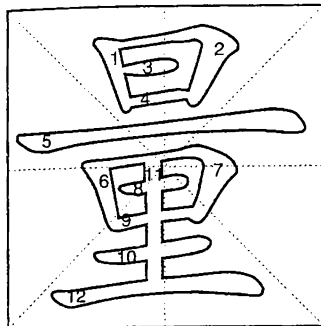

量 liàng 951

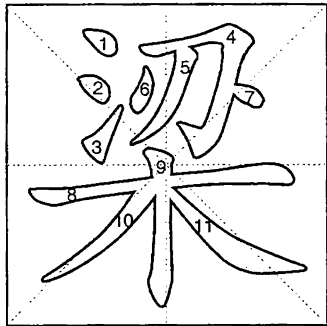

梁 liáng 952

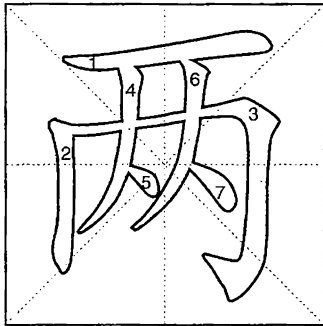

两 liǎng 953

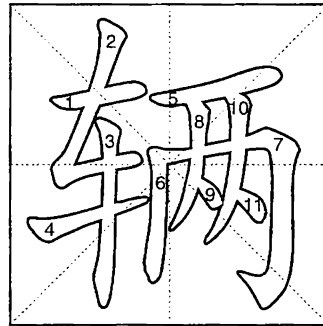

辆 liàng 954

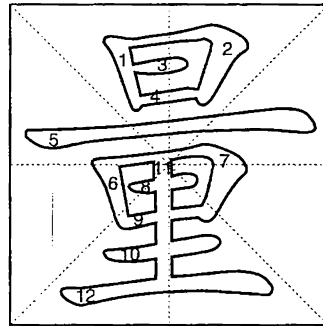

量 liàng 955

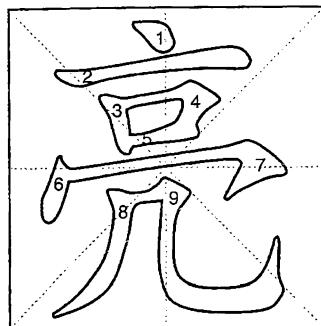

亮 liàng 956

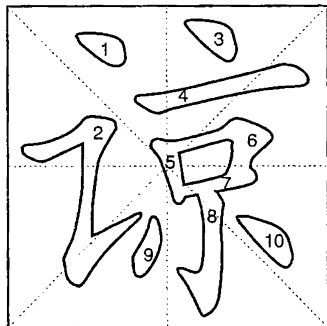

谅 liàng 957



聊 liáo 958

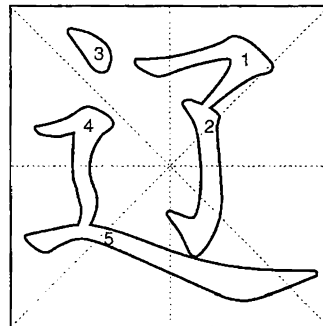

辽 liáo 959

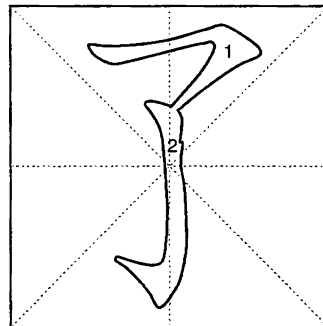

了 liǎo 960

### 凉 liáng

①cool; cold ②discouraged; disappointed

凉菜 liáng'cài

cold dish

凉快 liáng'kuài

nice and cool

凉台 liáng'tái

balcony

### 粮 liáng

grain; food; provisions

粮仓 liáng'cāng

barn

粮草 liáng'cǎo

army provisions

粮食 liáng'shí

grain; food

### 良 liáng

①good; fine ②good (people)

良方 liáng'fāng

effective prescription

良机 liáng'jī

golden opportunity

良田 liáng'tián

fertile farmland

### 练 liàn

①practise; train; drill ②experienced; skilled; seasoned

练兵 liàn'biāng

troop training

练习 liàn'xí

practice; exercise

练习本 liàn'xí'běn

exercise-book

### 炼 liàn

①smelt; refine

②temper with fire

炼钢 liàn'gāng

steel-making

炼铁 liàn'tiě

iron-smelting

炼油 liàn'yóu

oil-refining

### 量 liàng

①capacity ②quantity; amount; volume ③estimate; measure

量变 liàng'biàn

quantitative change

量力而行 liàng'lì'ér'xíng

act according to one's ability

量刑 liàng'xíng

measurement of penalty

### 辆 liàng

车辆 chē'liàng

vehicle; car

### 两 liǎng

①two ②both (sides); either (side)

③a few; some

④liang, a unit of weight(=50 grams)

两倍 liǎng'bèi

twofold; double

两党制 liǎng'dǎng'zhì

two-party system

两口子 liǎng'kǒu'zi

husband and wife

### 梁 liáng

①roof beam ②bridge

③(mountain) ridge

梁上君子 liáng'shàng'jūn'zi

thief

### 量 liáng

measure

量杯 liáng'bēi

measuring glass

量体温 liáng'tǐ'wēn

take sb.'s temperature

### 了 liǎo

①know clearly; understand

②end; finish; settle; dispose of

了不得 liǎo'bu'dé

terrific; extraordinary

了不起 liǎo'bu'qǐ

amazing; terrific

了如指掌 liǎo'rú'zhǐ'zhǎng

know sth. like one's hand

### 辽 liáo

distant

辽阔 liáo'kuò

vast; extensive

辽远 liáo'yuǎn

distant; faraway

### 聊 liáo

①merely; just

②a little; slightly ③chat

聊天 liáo'tiān

chat

聊以自慰 liáo'yǐ'zì'wèi

just to console oneself

### 谅 liàng

①forgive; understand

②think; suppose

谅解 liàng'jiě

make allowance for

谅解备忘录

liàng'jiě'bèi'wàng'lù

memorandum of understanding

### 亮 liàng

①bright; light ②shine ③loud and clear ④show

亮光 liàng'guāng

light

亮相 liàng'táng

light; bright; clear

亮相 liàng'xiàng

appear in public

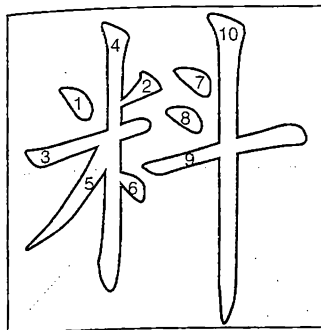

料 liào 961

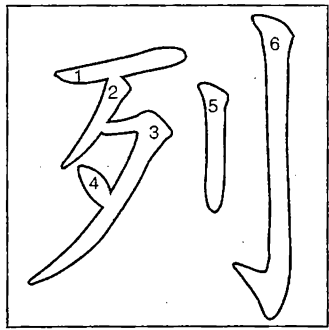

列 liè 962

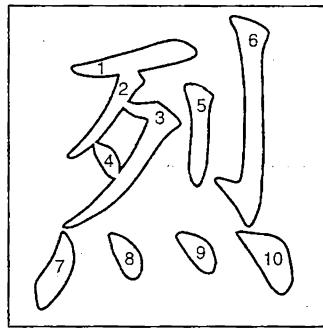

烈 liè 963

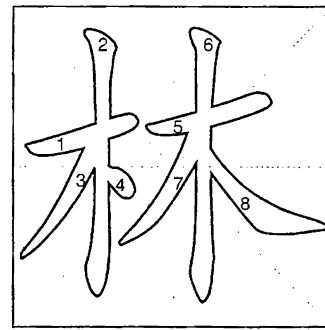

林 lín 964

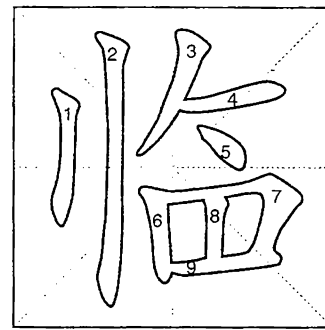

临 lín 965

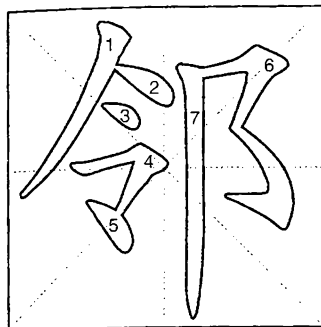

邻 lín 966

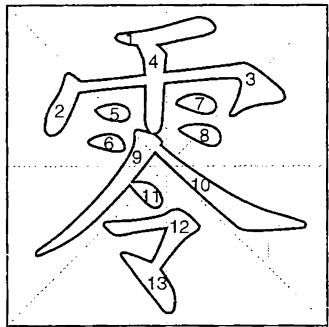

零 líng 967

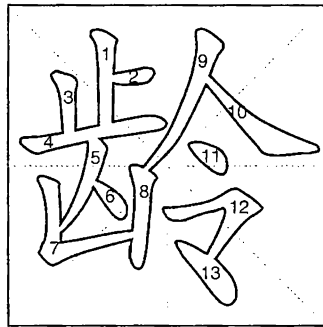

龄 líng 968

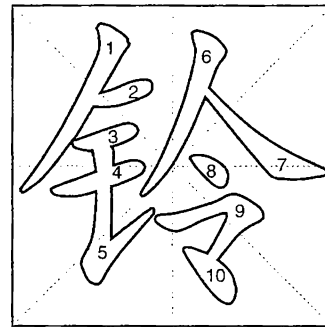

铃 líng 969

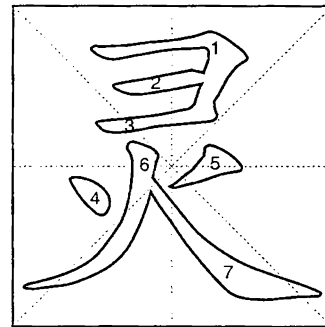

灵 líng 970

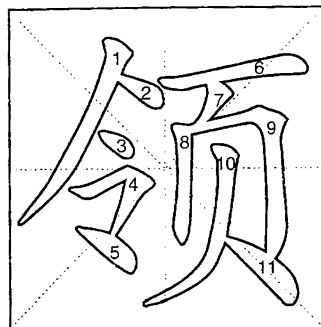

领 lǐng 971

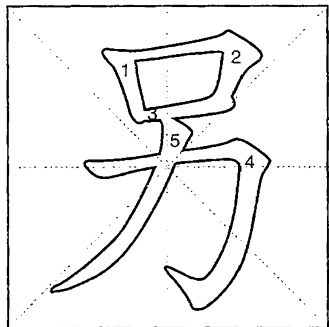

另 lìng 972

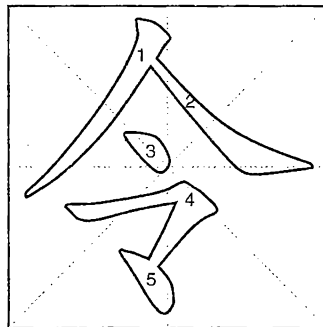

令 lìng 973



留 liú 974

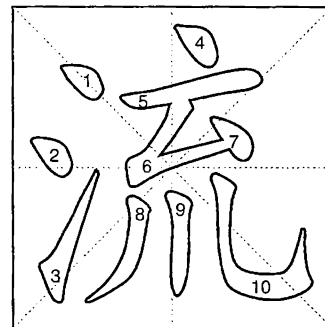

流 liú 975

### 临 lín

- ① face; overlook ② arrive; be present ③ just before; be about to ④ copy  
 临产 lín'chǎn  
 about to give birth  
 临近 lín'jìn  
 close to; close on  
 临时 lín'shí  
 temporary; provisional

### 林 lín

- ① forest; woods; grove ② circles ③ forestry  
 林产品 lín'chǎn'pǐn  
 forest products  
 林区 lín'qū  
 forest zone (region)  
 林业 lín'yè  
 forestry

### 烈 liè

- ① strong; violent; intense ② staunch; upright; stern  
 烈火 liè'huǒ  
 raging fire; raging flames  
 烈日 liè'rì  
 burning sun  
 烈士 liè'shì  
 martyr

### 列 liè

- ① arrange; line up ② list; enter in a list ③ row; file; rank ④ kind; sort ⑤ various; each and every  
 列兵 liè'bīng  
 private  
 列车 liè'chē  
 train  
 列席 liè'xí  
 attend a meeting

### 料 liào

- ① expect; anticipate ② material; stuff ③ (grain) feed  
 料酒 liào'jiǔ  
 cooking wine  
 料理 liào'lǐ  
 arrange; manage; Japanese cooking (dish)  
 料子 liào'zi  
 woollen fabric

### 灵 líng

- ① quick; clever; sharp ② efficacious; effective ③ spirit; intelligence ④ fairy; sprite ⑤ (remains) of the deceased; bier  
 灵车 líng'chē  
 hearse  
 灵活 líng'huó  
 nimble; agile; flexible  
 灵气 líng'qì  
 anima

### 铃 líng

- ① bell ② bell  
 铃铛 líng'dāng  
 small bell  
 铃声 líng'shēng  
 the tinkle of bells

### 龄 líng

- age; years; length of time  
 年龄 nián'líng  
 age

### 零 líng

- ① zero sign; nought ② odd; with a little extra ③ zero ④ nil  
 零(部)件 líng'(bù)jiàn  
 spare part  
 零点 líng'diǎn  
 zero point; zero hour  
 零度 líng'dù  
 zero

### 邻 lín

- ① neighbour ② near; adjacent  
 邻邦(国) lín'bāng(guó)  
 neighbouring country  
 邻近 lín'jìn  
 near; close to  
 邻居 lín'jū  
 neighbour

### 流 liú

- ① flow ② drifting; wandering ③ spread; circulate ④ stream of water ⑤ current ⑥ class; rate; grade  
 流传 liú'chuán  
 spread; circulate  
 流浪儿 liú'làng'er  
 waif; street urchin  
 流水线 liú'shuǐ'xiàn  
 assembly line

### 留 liú

- ① remain; stay ② ask sb. to stay ③ reserve; keep; save ④ grow; wear ⑤ accept; take ⑥ leave  
 留任 liú'rèn  
 remain in office  
 留心 liú'xīn  
 be careful; be attentive  
 留学 liú'xué  
 study abroad

### 令 lìng

- ① command; order ② make; cause ③ season ④ your  
 令爱 lìng'ài  
 your daughter  
 令郎 lìng'láng  
 your son  
 令堂 lìng'táng  
 your mother

### 另 lìng

- other; another; separate  
 另立户头 lìng'lì'hù'tóu  
 open another bank account  
 另起炉灶 lìng'qǐ'lú'zào  
 make a fresh start  
 另议 lìng'yì  
 be discussed separately

### 领 lǐng

- ① neck ② collar; neckband ③ outline ④ lead; usher ⑤ receive; draw; get  
 领土 lǐng'tǔ  
 territory  
 领养 lǐng'yǎng  
 adopt  
 领子 lǐng'zi  
 collar

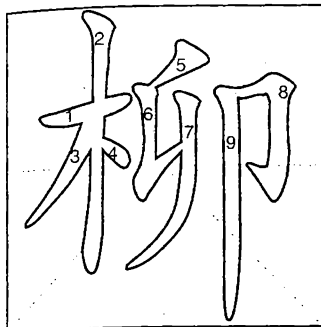

柳 liǔ

976

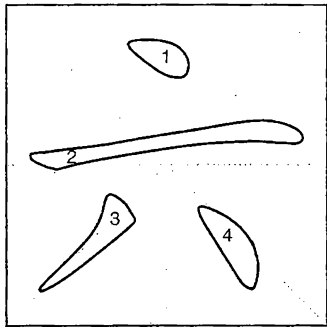

六 liù

977

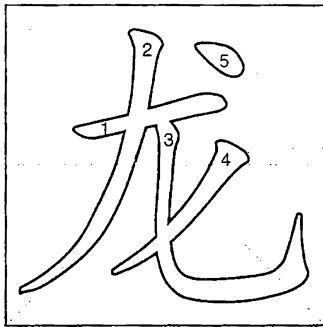

龙 lóng

978

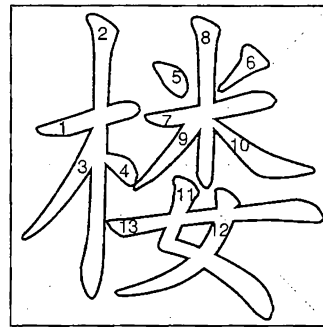

楼 lóu

979

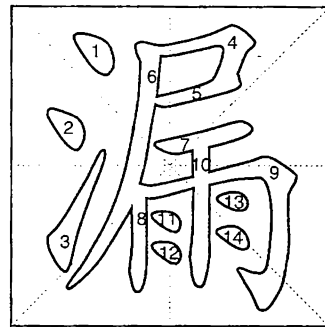

漏 lòu

980

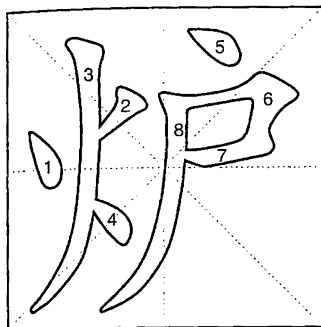

炉 lú

981

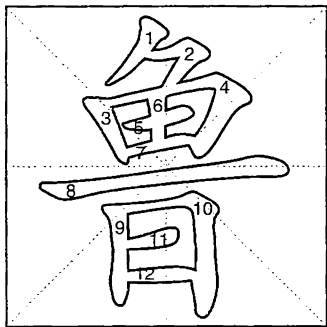

鲁 lǔ

982

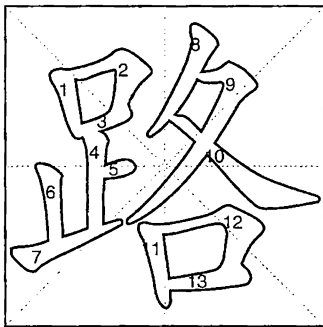

路 lù

983

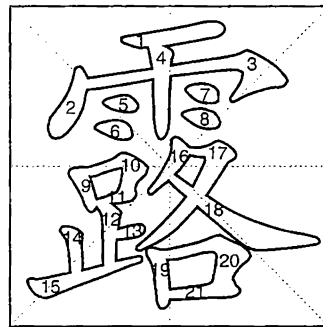

露 lù

984

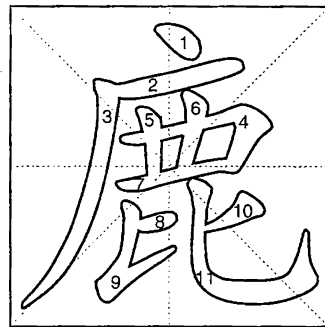

鹿 lù

985

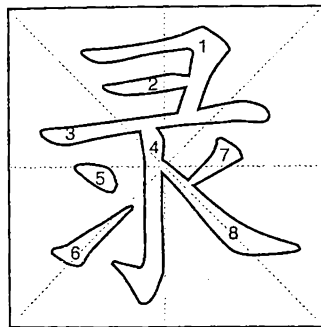

录 lù

986

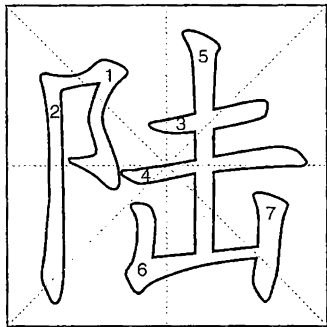

陆 lù

987

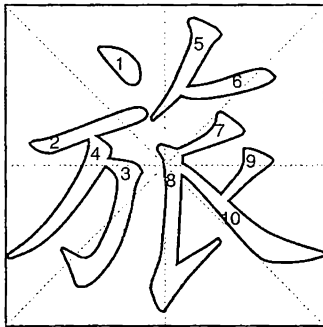

旅 lǚ

988

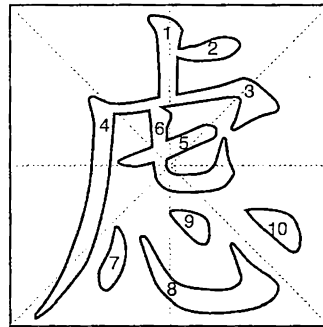

虑 lǜ

989

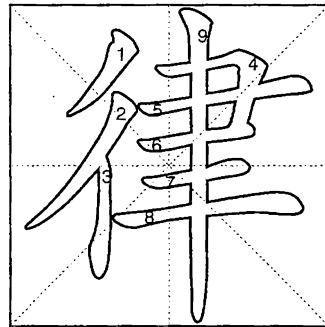

律 lǜ

990



### 漏 lòu

①leak ②divulge; leak ③be missing; leave out  
 漏电 lòu'diàn  
 leakage of electricity  
 漏光 lòu'guāng  
 light leak  
 漏税 lòu'shuì  
 evade taxation

### 楼 lóu

①a storied building ②storey; floor  
 楼上 lóu'shàng  
 upstairs  
 楼梯 lóu'tī  
 stairs; staircase  
 楼下 lóu'xià  
 downstairs

### 龙 lóng

①dragon ②imperial  
 龙船 lóng'chuán  
 dragon boat  
 龙卷风〈气〉 lóng'juǎn'fēng〈qì〉  
 tornado  
 龙虾 lóng'xiā  
 lobster

### 六 liù

six  
 六边形 liù'biān'xíng  
 hexagon; hexagonal  
 六弦琴 liù'xián'qín  
 guitar  
 六月 liù'yuè  
 June

### 柳 liǔ

willow  
 柳条 liǔ'tiáo  
 willow twig; wicker  
 柳絮 liǔ'xù  
 willow catkins  
 柳枝 liǔ'zhī  
 willow branch

### 鹿 lù

鹿角 lù'jiǎo  
 deerhorn antler; abatis  
 鹿茸〈中药〉 lù'róng〈zhōng'yào〉  
 pilose antler  
 鹿死谁手 lù'sí'shuì'shǒu  
 who will win the prize

### 露 lù

①dew ②syrup ③show; reveal  
 露水 lù'shuǐ  
 dew  
 露营 lù'yíng  
 camp; encamp; bivouac  
 露珠 lù'zhū  
 dewdrop

### 路 lù

①road; path; way ②journey; distance ③means ④sequence; line; logic ⑤region; district  
 路灯 lù'dēng  
 street lamp  
 路口 lù'kǒu  
 crossing; intersection  
 路透社 lù'tòu'shè  
 Reuters

### 鲁 lǔ

①stupid; dull ②rash; rough;  
 rude  
 鲁莽 lǔ'mǎng  
 crude and rash

### 炉 lú

①stove; furnace; oven ②heat  
 炉灰 lú'huī  
 ashes of a stove  
 炉灶 lú'zào  
 kitchen range  
 炉子 lú'zi  
 stove; furnace

### 律 lǜ

①law; statute; rule ②restrain  
 律己 lǜ'jǐ  
 discipline oneself  
 律师 lǜ'shī  
 lawyer; barrister  
 律师费 lǜ'shī'fèi  
 counsel fee

### 虑 lǜ

①consider; ponder; think over  
 ②concern; anxiety; worry  
 考虑 kǎo'lǜ  
 think over; consider  
 顾虑 gù'lǜ  
 worry; misgiving

### 旅 lǚ

①travel ②brigade ③troops;  
 ④force  
 旅馆 lǚ'guǎn  
 hotel  
 旅客 lǚ'kè  
 passenger; hotel guest  
 旅行 lǚ'xíng  
 travel; journey; tour

### 陆 lù

land  
 陆地 lù'dì  
 dry land; land  
 陆军 lù'jūn  
 army; ground force  
 陆运 lù'yùn  
 land transportation

### 录 lù

①record; write down; copy  
 ②employ; hire ③tape-record  
 ④register; collection  
 录取 lù'qǔ  
 enroll; admit  
 录像 lù'xiàng  
 video recording  
 录音 lù'yīn  
 recording

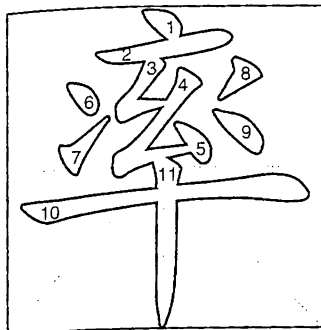

率 lǜ 991



绿 lǜ 992

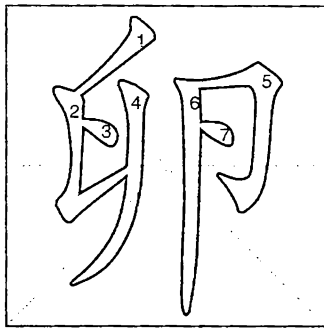

卯 mǎo 993

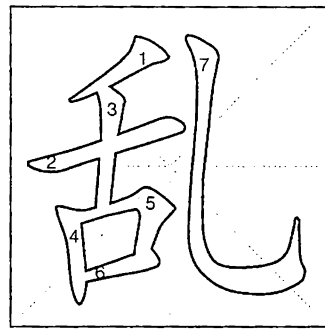

乱 luàn 994

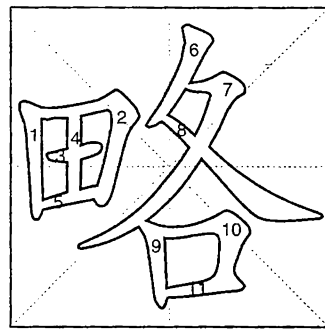

略 lüè 995



轮 lún 996



论 lùn 997

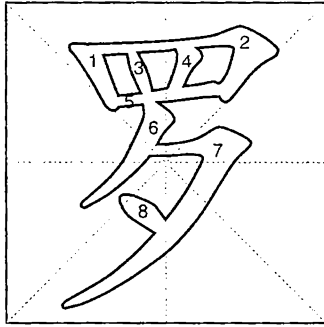

罗 luó 998

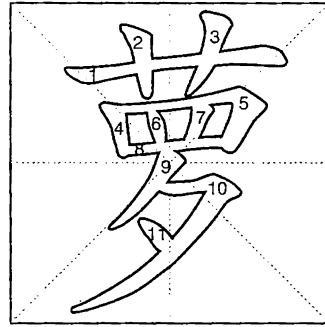

萝 luó 999

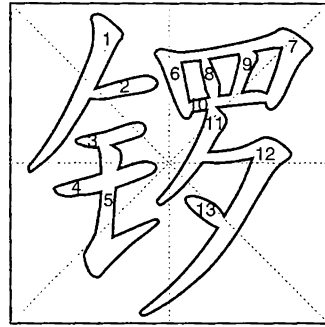

锣 luó 1000

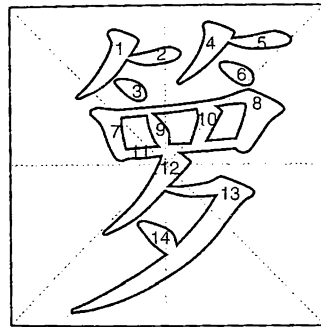

萝 luó 1001

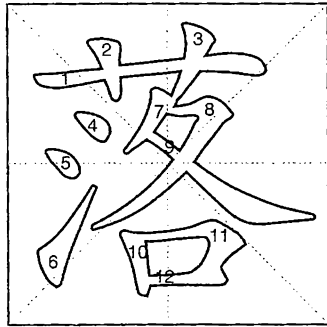

落 luò 1002

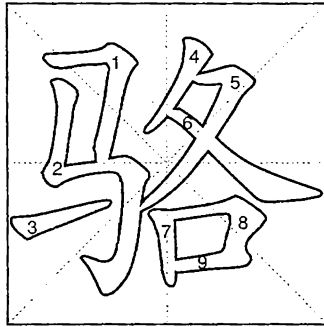

骆 luò 1003

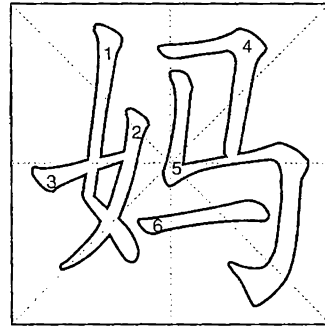

妈 mā 1004

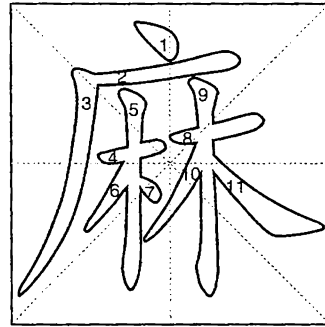

麻 má 1005

### 略 lüè

① brief; sketchy ② slightly; a little; somewhat ③ summary; brief account; outline ④ omit; delete; leave out  
 略图 lüè'tú  
 sketch map  
 略语 lüè'yǔ  
 abbreviation  
 略知一二 lüè'zhī'yī'èr  
 know sth. about

### 乱 luàn

① in disorder; in a mess; in confusion ② disorder; chaos; riot; turmoil ③ confuse; mix up; jumble  
 乱成一团 luàn'chéng'yī'tuán  
 in great confusion  
 乱码 luàn'mǎ  
 error codes  
 乱子 luàn'zi  
 disturbance

### 卵 luǎn

ovum; egg; spawn  
 卵巢 luǎn'cháo  
 ovary  
 卵石 luǎn'shí  
 cobble; pebble; shingle  
 卵子 luǎn'zi  
 ovum; egg; testis

### 绿 lǜ

green  
 绿宝石 lǜ'bǎo'shí  
 emerald  
 绿豆 lǜ'dòu  
 green gram  
 绿卡 lǜ'kǎ  
 green card

### 率 lǜ

rate; proportion; ratio  
 利率 lǜ'lǜ  
 interest rate

### 锣 luó

gong  
 锣鼓 luó'gǔ  
 gong and drum

### 萝 luó

trailing plants  
 萝卜 luó'bo  
 radish  
 萝卜干 luó'bo'gān  
 dried radish

### 罗 luó

① a net for catching birds ② catch (birds) with a net ③ collect; gather together ④ display; spread out  
 罗马教皇 luó'mǎ'jiào'huáng  
 the Pope  
 罗马数字 luó'mǎ'shù'zì  
 Roman numerals  
 罗盘 luó'pán  
 compass

### 论 lùn

① discuss; discourse ② view ③ dissertation; essay ④ theory ⑤ mention; regard; consider  
 论点 lùn'diǎn  
 argument point(of view)  
 论坛 lùn'tán  
 forum  
 论文 lùn'wén  
 paper; article; thesis

### 轮 lún

① wheel ② disc; ring ③ steamboat ④ take turns ⑤ round  
 轮船 lún'chuán  
 ship; steamer  
 轮胎 lún'tāi  
 type  
 轮椅 lún'yǐ  
 wheelchair

### 麻 má

① a general term for hemp, flax, etc. ② sesame ③ pocked; pitted; spotty ④ tingle  
 麻将 má'jiàng  
 mahjong  
 麻药 má'yào  
 anaesthetic  
 麻醉品 má'zuì'pǐn  
 narcotic; drug

### 妈 mā

① ma; mother ② aunt  
 妈妈 mā'mā  
 mum; mother

### 骆 luò

骆驼 luò'tuo  
 camel

### 落 luò

① fall; drop ② go down; set ③ lower ④ decline; sink ⑤ lag behind ⑥ leave behind  
 落地灯 luò'dì'dēng  
 floor lamp  
 落泪 luò'lèi  
 weep; shed tears  
 落选 luò'xuǎn  
 lose an election

### 箩 luó

a square-bottomed bamboo basket  
 箩筐 luó'kuāng  
 a large bamboo basket

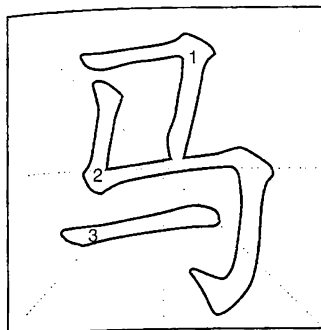

马 mǎ 1006

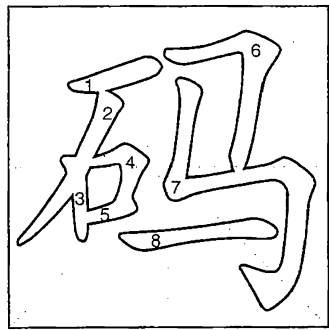

码 mǎ 1007

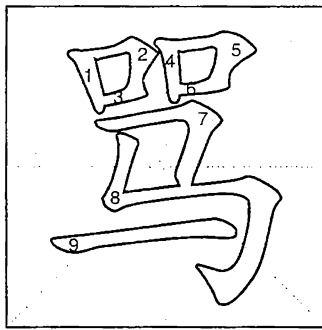

骂 mà 1008

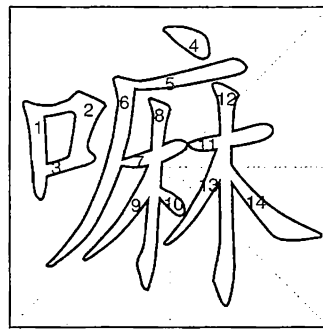

嘛 ma 1009

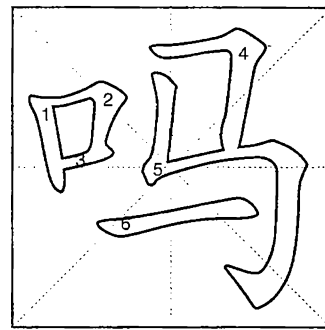

吗 ma 1010

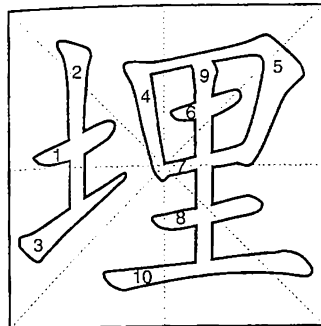

埋 mái 1011

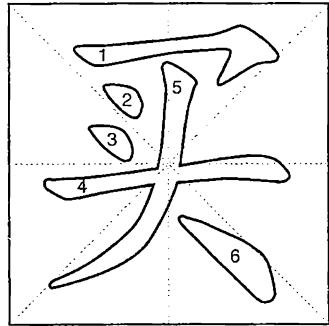

买 mǎi 1012

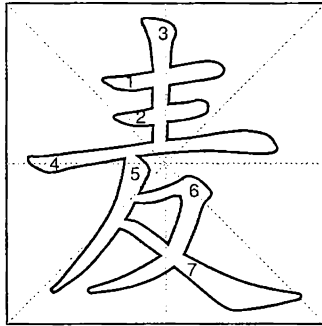

麦 mài 1013

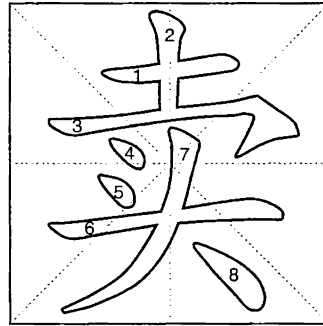

卖 mài 1014

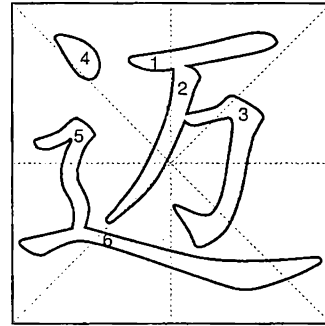

迈 mài 1015



脉 mài 1016



瞒 mán 1017



馒 mán 1018

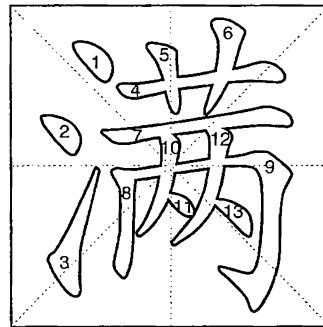

满 mǎn 1019

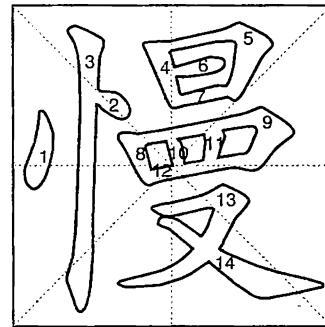

慢 màn 1020

**吗 ma**

你好吗? nǐ'hǎo'ma?

How are you?

**嘛 ma**

不让你去, 就别去嘛。

bù'ràng'nǐ'qù, jiù'bié'qù'ma。

Don't go if you are not asked to.

**骂 mà**

① abuse; curse; swear ② condemn; rebuke; reprove

骂街 mà'jiē

shout abuses in the street

骂名 mà'míng

bad name; infamy

**码 mǎ**

① a sign of thing indicating number ② pile up; stack ③ yard

码放 mǎ'fàng

pile up; stack

码头 mǎ'tóu

wharf; dock; quay; pier

码头工人 mǎ'tóu'gōng'rén

docking; stevedore

**马 mǎ**

horse

马车 mǎ'chē

(horse-drawn) carriage

马拉松 mǎ'lǎ'sōng

marathon

马铃薯 mǎ'líng'shǔ

potato

**迈 mài**

step; stride

迈步 mài'bù

step forward; take a step

迈进 mài'jìn

stride forward

**卖 mài**

① sell ② betray ③ exert to the utmost; not spare ④ show off

卖方 mài'fāng

seller

卖价 mài'jià

selling price

卖主 mài'zhǔ

bargainer; seller

**麦 mài**

① a general term for wheat, barley, etc. ② wheat

麦片 mài'piàn

oatmeal

麦芽 mài'yá

malt

麦子 mài'zi

wheat

**买 mǎi**

buy; purchase

买方 mǎi'fāng

buyer

买价 mǎi'jià

buying price

买卖 mǎi'mài

business; trade

**埋 mái**

cover up (with earth); bury

埋(买)单 mái'mǎi'dān

pay the bill for a meal at a restaurant

埋伏 mái'fú

ambush; lie in ambush

埋葬 mái'zàng

bury; burial

**慢 màn**

① slow ② postpone; defer

慢车道 màn'chē'dào

slow-traffic lanes

慢慢 màn'man

slowly; leisurely

慢跑 màn'pǎo

jog

**满 mǎn**

① full; filled; packed ② fill ③

expire; reach the limit ④ entirely; completely ⑤ satisfied

满分 mǎn'fēn

full mark

满意 mǎn'yì

satisfied; pleased

满座 mǎn'zuò

full house

**馒 mǎn**

馒头 mǎn'tou

steamed bun (bread)

**瞒 mán**

hide the truth from

瞒报 mán'bào

give a false report

瞒哄 mán'hǒng

deceive

瞒天过海 mán'tiān'guò'hǎi

practice deception

**脉 mài**

① arteries and veins ② pulse

③ vein

脉搏 mài'bó

pulse

脉冲〈物〉 mài'chōng〈wù〉

pulse

脉弱〈中〉 mài'ruò〈zhōng〉

weak pulse

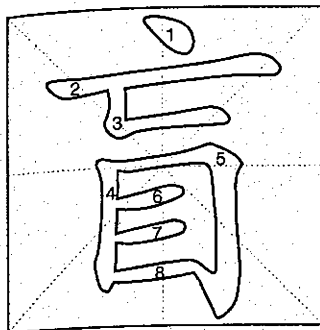

盲 máng 1021

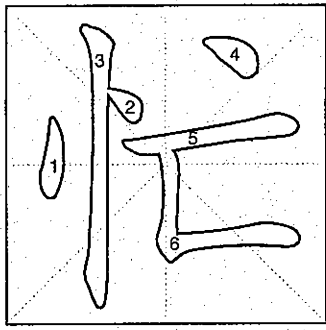

忙 máng 1022

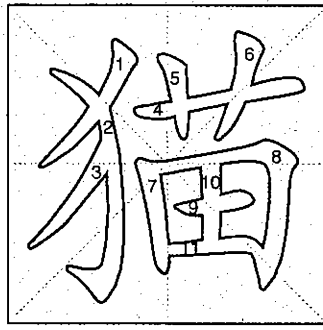

猫 māo 1023

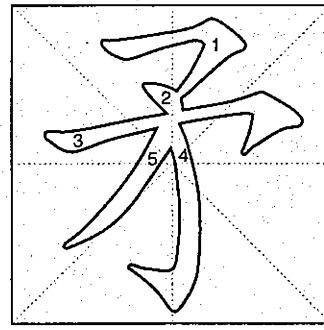

矛 máo 1024

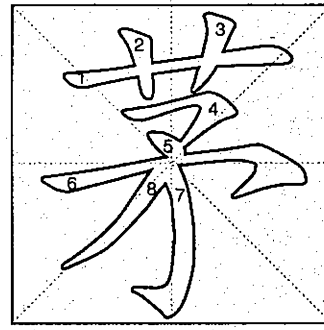

茅 máo 1025

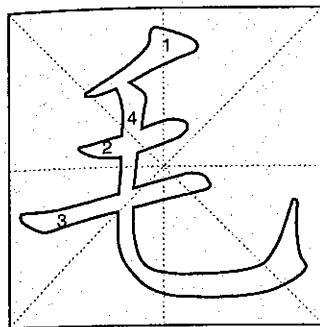

毛 máo 1026

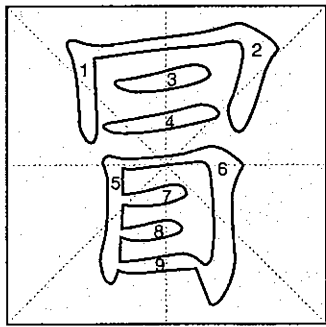

冒 mào 1027

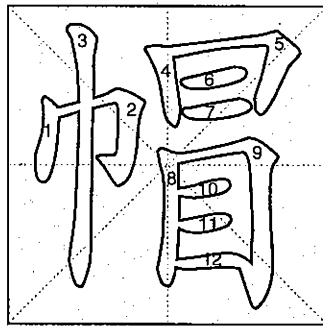

帽 mào 1028

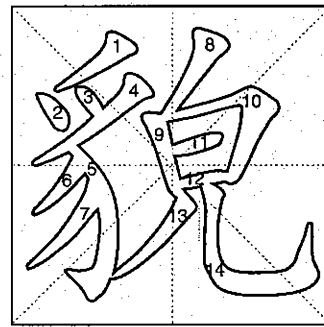

貌 mào 1029

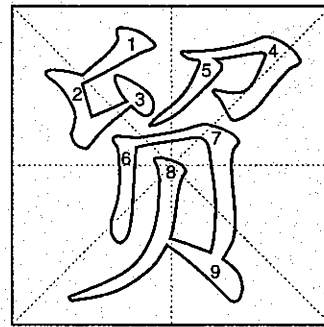

贺 mào 1030

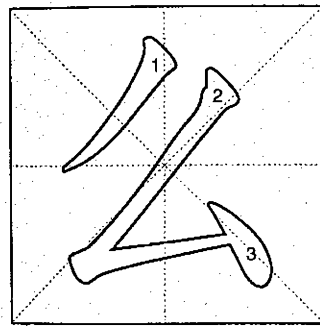

么 me 1031

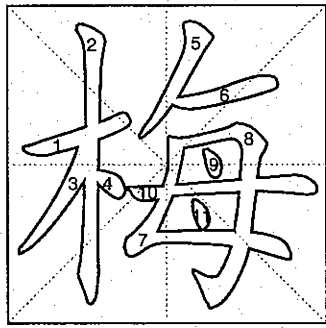

梅 méi 1032

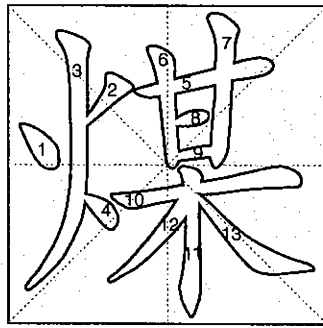

煤 méi 1033

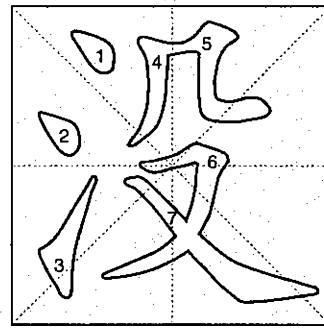

没 méi 1034

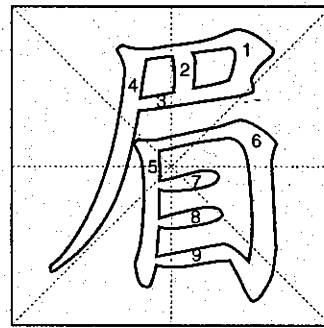

眉 méi 1035

**茅 máo**

cogongrass  
茅草 máo'cǎo  
cogongrass  
茅舍 máo'shè  
thatched cottage  
茅屋 máo'wū  
thatched cottage

**矛 máo**

lance; pike, spear  
矛盾 máo'dùn  
contradiction  
矛头 máo'tóu  
spearhead

**猫 māo**

cat  
猫头鹰 māo'tóu'yīng  
owl  
猫眼〈电〉 māo'yǎn(diàn)  
cat eye

**忙 máng**

① busy; fully occupied ② hurry;  
hasten  
忙碌 máng'lù  
busy; engaged  
忙乱 máng'luàn  
in a bustle  
忙音 máng'yīn  
busy back tone; busy tone

**盲 máng**

blind  
盲肠 máng'cháng  
caecum  
盲目 máng'mù  
blind  
盲人 máng'rén  
blind person

**贸 mào**

trade  
贸易 mào'yì  
trade; commerce  
贸易保护主义  
mào'yì'bǎo'hù'zhǔ'yì  
trade protectionism  
贸易壁垒 mào'yì'bì'lěi  
trade barriers

**貌 mào**

looks; appearance  
貌不惊人 mào'bù'jīng'rén  
look mediocre  
貌似 mào'sì  
seemingly; in appearance

**帽 mào**

headgear; hat; cap  
帽舌 mào'shé  
peak (of a cap); visor  
帽子 mào'zi  
hat; cap; label; tag  
帽子戏法 mào'zi'xì'fǎ  
hat trick (three goals scored by  
the same player in a game of  
soccer)

**冒 mào**

① emit; send out ② risk; brave  
③ boldly; rashly ④ falsely (claim,  
etc.); fraudulently  
冒号 mào'hào  
colon  
冒牌 mào'pái  
forge a trade mark  
冒险家 mào'xiǎnjiā  
adventurer

**毛 máo**

① hair; feather ② wool ③ mildew  
④ semifinished ⑤ gross ⑥ little;  
small  
毛笔 máo'bǐ  
writing brush  
毛发 máo'fà  
hair  
毛利 máo'lì  
gross profit

**眉 méi**

① eyebrow; brow  
② the top margin of a page  
眉笔 méi'bǐ  
eyebrow pencil  
眉目 méi'mù  
looks; logic; outline  
眉头 méi'tóu  
brows; 皱-frown

**没 méi**

not have; there is not; be without  
没赶上 méi'gǎn'shàng  
miss  
没关系 méi'guān'xi  
it doesn't matter  
没脸 méi'liǎn  
too shame to; lose face

**煤 méi**

coal  
煤气 méi'qì  
gas  
煤炭 méi'tàn  
coal  
煤油 méi'yóu  
kerosene; paraffin

**梅 méi**

plum  
梅花 méi'huā  
plum blossom  
梅花鹿 méi'huā'lù  
spotted deer  
梅子 méi'zi  
plum

**么 me**

什么 shén'me  
what  
多么 duō'me  
how

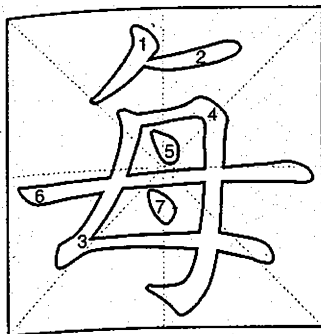

每 měi 1036

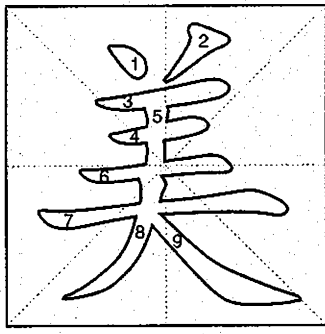

美 měi 1037

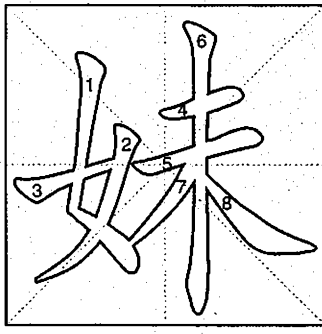

妹 mèi 1038

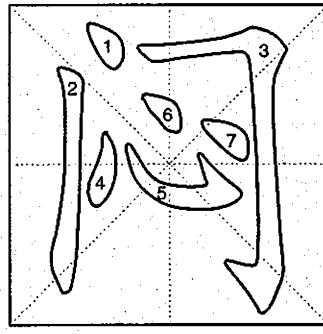

闷 mēn 1039

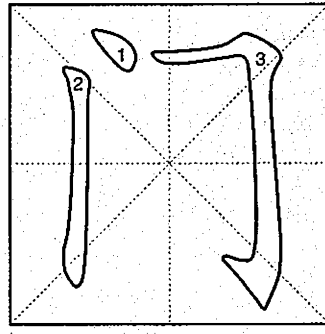

门 mén 1040

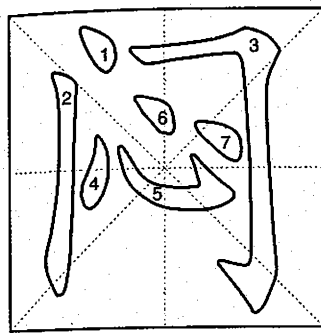

闷 mèn 1041

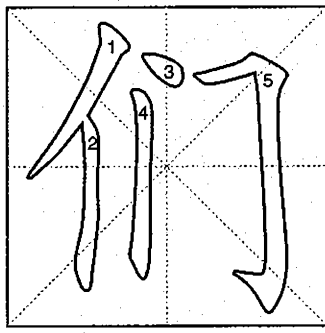

们 men 1042

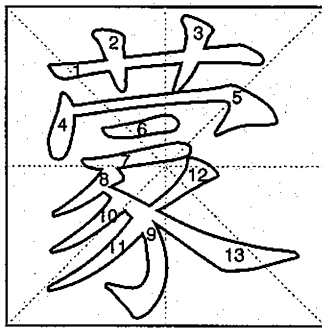

蒙 méng 1043

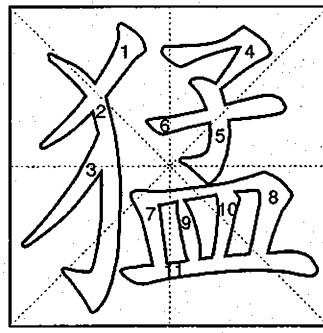

猛 měng 1044

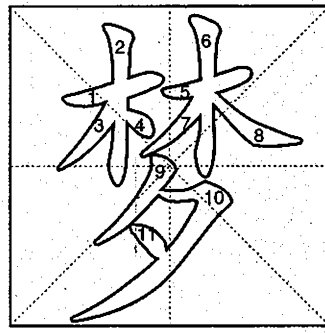

梦 mèng 1045

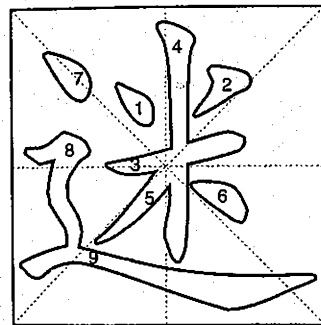

迷 mí 1046

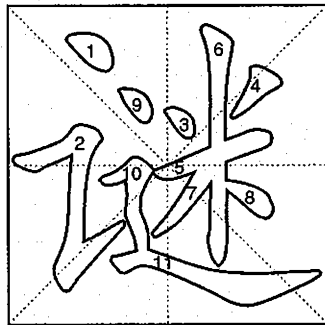

谜 mí 1047

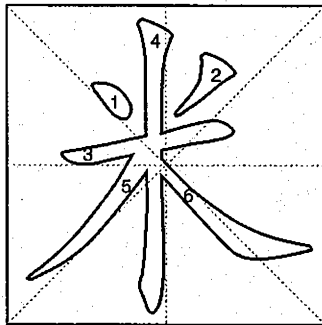

米 mǐ 1048

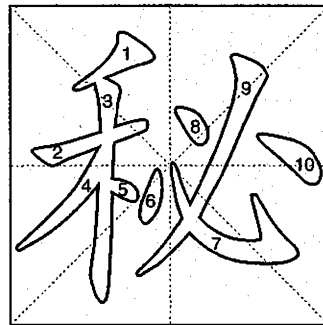

秘 mì 1049

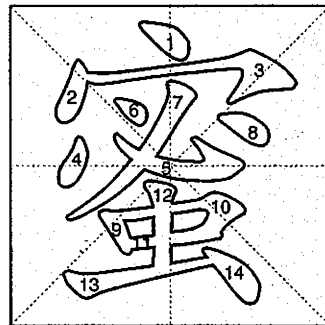

蜜 mì 1050



### 门 mén

门牌 mén'pái  
house number  
门锁 mén'suǒ  
door lock  
门诊部 mén'zhěn'bù  
clinic

### 闷 mēn

①stuffy; close ②cover tightly  
③(of a sound) muffled  
④shut oneself or sb. indoors  
闷气 mēn'qì  
stuffy; close  
闷热 mēn'rè  
hot and suffocating

### 妹 mèi

younger sister; sister  
妹夫 mèi'fū  
brother-in-law  
妹妹 mèi'mei  
sister; younger sister

### 美 měi

①beautiful; pretty  
②very satisfactory; good  
美发厅 měi'fà'tīng  
hair salon  
美工 měi'gōng  
art designing (designer)  
美金(元) měi'jīn(yuán)  
U. S. dollar

### 每 měi

①every; each; per ②often  
每次 měi'cì  
every time  
每年 měi'nián  
yearly; every each year  
每月 měi'yue  
monthly; every each month

### 梦 mèng

dream  
梦话 mèng'huà  
sommiloquy; daydream  
梦见 mèng'jiàn  
see in a dream  
梦乡 mèng'xiāng  
dreamland

### 猛 měng

① fierce; violent; energetic;  
vigorous ②suddenly; abruptly  
猛烈 měng'liè  
fierce; violent; vigorous  
猛敲 měng'qiāo  
bang  
猛醒 měng'xǐng  
suddenly wake up

### 蒙 méng

①cover ②ignorant; illiterate  
蒙混 méng'hùn  
mislead (people)  
蒙受 méng'shòu  
suffer; sustain  
蒙在鼓里 méng'zài'gǔ'lǐ  
be in the dark

### 们 men

我们 wǒ'men  
we  
他们 tā'men  
they

### 闷 mèn

①bored ②tightly closed; sealed  
闷葫芦 mèn'hú'lu  
mystery; puzzle  
闷雷 mèn'léi  
dull thunder  
闷闷不乐 mèn'mèn'bù'lè  
in low spirits

### 蜜 mì

①honey ②honeyed; sweet  
蜜蜂 mì'fēng  
bee; honeybee  
蜜月 mì'yue  
honeymoon  
蜜枣 mì'zǎo  
candied date; jujube

### 秘 mì

①secret  
②keep sth. secret; hold sth. back  
秘方 mì'fāng  
secret recipe  
秘密 mì'mì  
secret; confidential  
秘书 mì'shū  
secretary

### 米 mǐ

①rice ②shelled or husked seed  
③metre  
米饭 mǐ'fàn  
rice  
米酒 mǐ'jiǔ  
rice wine  
米色 mǐ'sè  
cream-coloured

### 谜 mí

①riddle; conundrum  
②enigma; mystery; puzzle  
谜底 mí'dǐ  
answer to a riddle  
谜语 mí'yǔ  
riddle; conundrum

### 迷 mí

① be confused; be lost ② be  
fascinated by ③fan; enthusiast; fiend  
④ confuse; perplex  
迷彩服 mí'cǎi'fú  
camouflage suit  
迷恋 mí'liàn  
madly cling to  
迷失 mí'shī  
lose

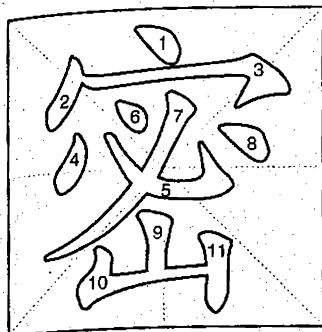

密 mì 1051

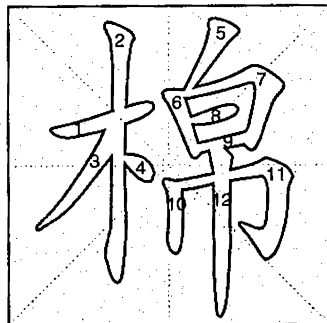

棉 mián 1052



眠 mián 1053

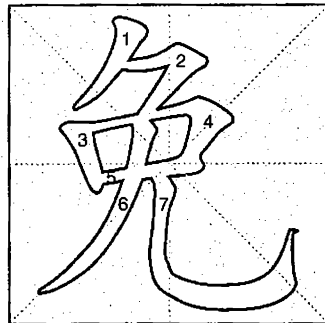

免 miǎn 1054

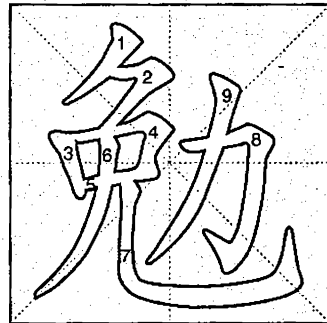

勉 miǎn 1055

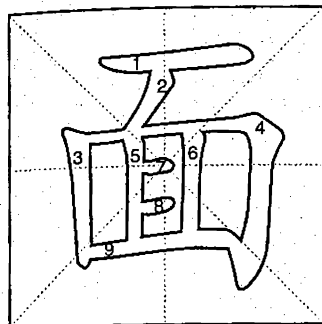

面 miàn 1056

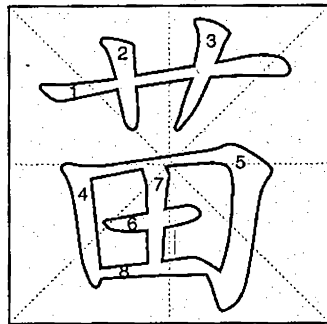

苗 miáo 1057

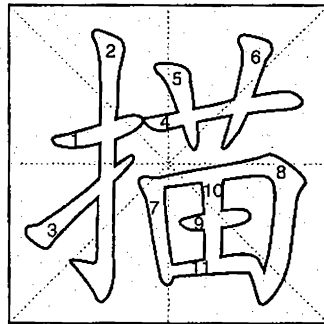

描 miáo 1058

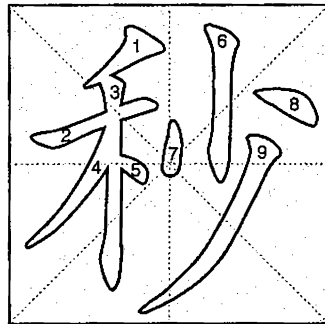

秒 miǎo 1059

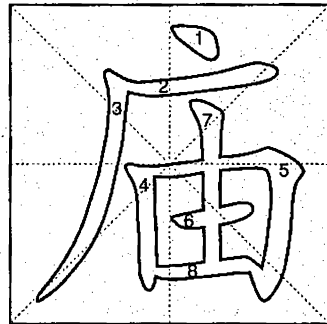

庙 miào 1060

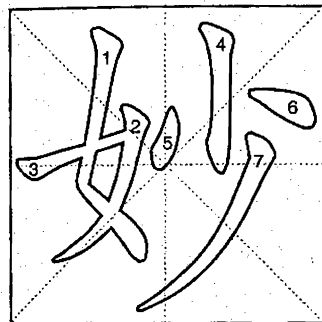

妙 miào 1061

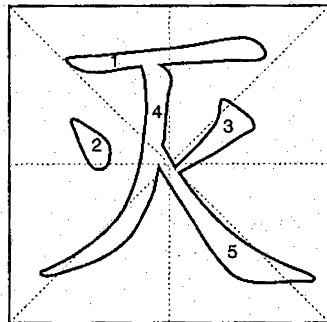

灭 miè 1062

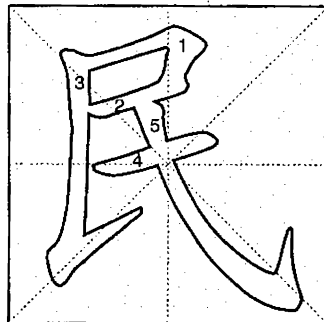

民 mín 1063

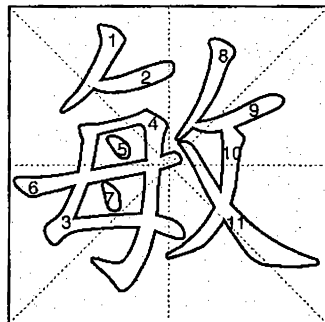

敏 mǐn 1064

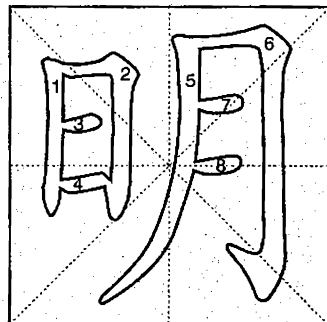

明 míng 1065

**勉 miǎn**

- ① exert oneself; strive  
 ② encourage; urge; exhort  
 ③ strive to do what is beyond one's power  
 勉励 miǎn'li  
 encourage; urge  
 勉强 miǎn'qiǎng  
 do with difficulty

**免 miǎn**

- ① excuse sb. from sth.; exempt; dispense with ② remove from office; dismiss; relieve ③ avoid  
 免费 miǎn'fèi  
 free; gratis  
 免烫 miǎn'tàng  
 non-ironing  
 免职 miǎn'zhí  
 remove sb. from office

**眠 mián**

- ① sleep ② dormancy  
 睡眠 shuì'mián  
 sleep

**棉 mián**

- ① cotton ② cotton-padded; cotton quilted (padded) clothes  
 棉花 mián'huā  
 cotton  
 棉球 mián'qiú  
 cotton balls; cotton wool  
 棉衣 mián'yī  
 cotton-padded clothes

**密 mì**

- ① close; dense; thick  
 ② intimate ③ fine; meticulous  
 ④ secret  
 密电 mì'diàn  
 cipher telegram  
 密封 mì'fēng  
 seal up; seal airtight  
 密码 mì'mǎ  
 cipher; cipher code

**庙 miào**

- ① temple; shrine ② temple fair  
 庙会 miào'huì  
 temple fair  
 庙宇 miào'yǔ  
 temple

**秒 miǎo**

- second  
 秒表 miǎo'biǎo  
 stopwatch; chronograph  
 秒针 miǎo'zhēn  
 second hand

**描 miáo**

- ① trace; copy (designs, etc.)  
 ② touch up; retouch  
 描绘 miáo'huì  
 depict; portray; describe  
 描述 miáo'shù  
 describe  
 描写 miáo'xiě  
 describe; paint; portrait

**苗 miáo**

- ① young plant; seedling 麦~ wheat seedling ② the young of some animals 鱼~ fry  
 苗圃 miáo'pǔ  
 nursery  
 苗条 miáo'tiáo  
 slim; slender  
 苗头 miáo'tou  
 symptom of a trend

**面 miàn**

- ① face ② face (a certain direction)  
 ③ surface; top ④ personally; directly  
 ⑤ cover; outside  
 面包 miàn'bāo  
 bread; ~房 bakery  
 面对 miàn'duì  
 face; confront  
 面粉 miàn'fěn  
 flour: ~厂 flour mill

**明 míng**

- ① bright; brilliant; light ② clear; distinct ③ open; overt; explicit  
 ④ sharp-eyed; clear-sighted  
 ⑤ aboveboard; honest  
 明白 míng'bái  
 clear; plain; know  
 明亮 míng'liàng  
 light; bright; shining  
 明年 míng'nián  
 next year

**敏 mǐn**

- quick; agile  
 敏感 mǐn'gǎn  
 sensitive; susceptible  
 敏捷 mǐn'jié  
 quick; agile; nimble  
 敏锐 mǐn'ruì  
 sharp; acute; keen

**民 mín**

- ① the people ② a person of a certain occupation ③ folk  
 ④ civilian  
 民法 mín'fǎ  
 civil law  
 民间文学 mín'jiān'wén'xué  
 folk literature  
 民宅 mín'zhái  
 private residence

**灭 miè**

- ① go out ② put out; turn off  
 ③ submerge ④ destroy; exterminate;  
 wipe out  
 灭火 miè'huǒ  
 put out a fire  
 灭口 miè'kǒu  
 do away with a witness  
 灭亡 miè'wáng  
 ruin; perish; die out

**妙 miào**

- ① wonderful; excellent; fine  
 ② ingenious; clever; subtle  
 妙计 miào'jì  
 excellent plan  
 妙诀 miào'jué  
 knack  
 妙龄 miào'líng  
 young; youthful

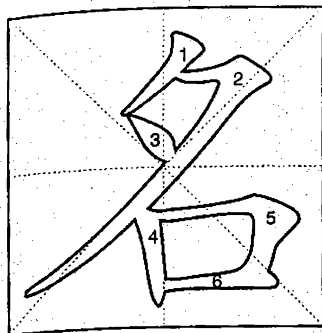

名 míng 1066

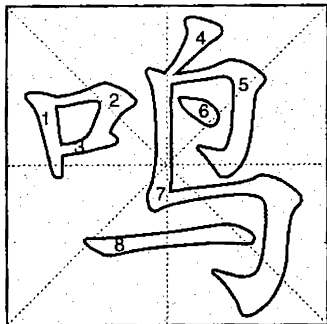

鳴 míng 1067

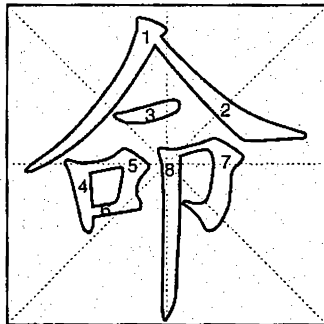

命 mìng 1068

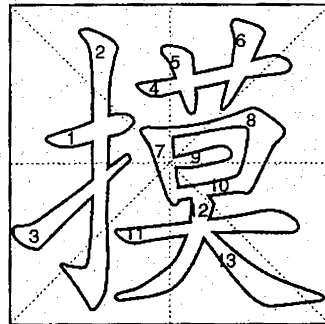

摸 mō 1069

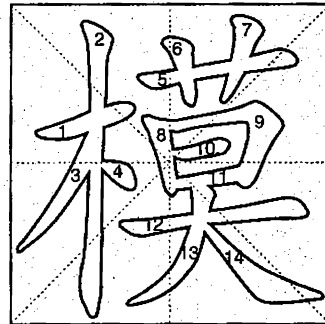

模 mó 1070

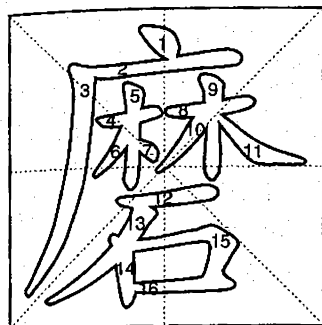

磨 mó 1071

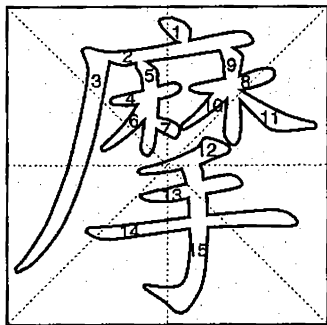

摩 mó 1072

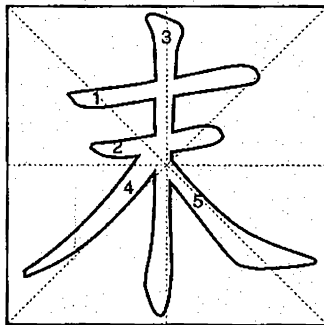

末 mò 1073

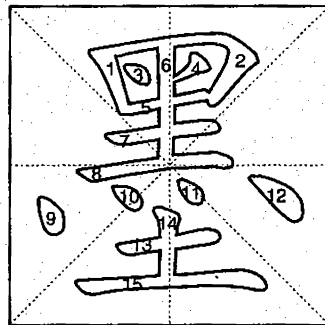

墨 mò 1074

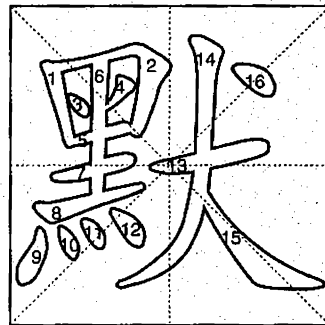

默 mò 1075

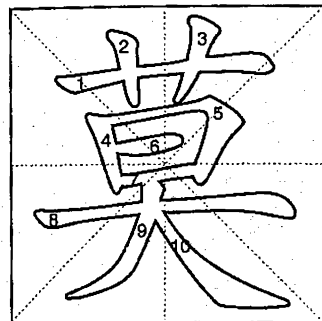

莫 mò 1076

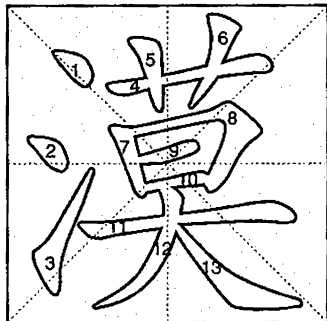

漠 mò 1077

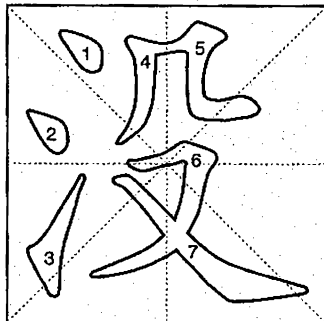

沒 mò 1078

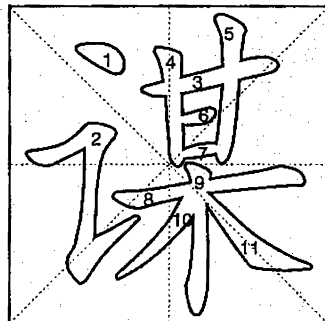

謀 móu 1079

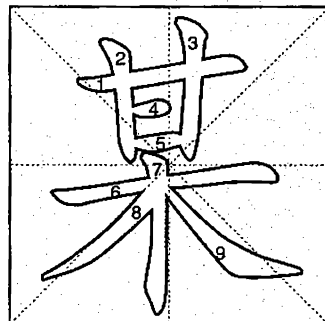

某 mǒu 1080

### 模 mó

- ① pattern; standard ② imitate  
 ③ model  
 模仿 mó'fǎng  
 imitate; copy  
 模特儿 mó'tè'r  
 model  
 模型 mó'xíng  
 model; pattern; mold

### 摸 mō

- ① feel; stroke; touch ② feel for;  
 fumble  
 ③ try to find out; feel out  
 摸不透 mō'bù'tòu  
 wonder; be puzzled  
 摸黑儿 mō'hēi'r  
 in the dark  
 摸索 mō'suǒ  
 feel about; grope

### 命 mìng

- ① life ② lot; fate; destiny ③  
 order; command ④ assign (a name,  
 title, etc)  
 命令 mìng'lìng  
 order; command  
 命运 mìng'yùn  
 destiny; fate; lot  
 命中 mìng'zhòng  
 hit the target

### 鸣 míng

- ① the cry of birds, animals or  
 insects ② ring; sound ③ express;  
 voice; air  
 鸣笛 míng'dí  
 blow a whistle  
 鸣礼炮 míng'lǐ'pào  
 fire a salute  
 鸣枪 míng'qiāng  
 fire a shot

### 名 míng

- ① name ② given name ③ fame;  
 reputation; renown ④ famous;  
 celebrated ⑤ express; describe  
 名片 míng'piàn  
 visiting card; calling card  
 名人 míng'rén  
 notable; celebrity  
 名胜 míng'shèng  
 famous sites

### 默 mò

- ① silent; tacit ② write from memory  
 默哀 mò'āi  
 stand in silent tribute  
 默认(许) mò'rèn(xǔ)  
 acquiesce in; tacitly accept  
 默写 mò'xiě  
 write from memory

### 墨 mò

- ① ink stick ② ink ③ handwriting  
 or painting ④ black; pitch-dark  
 墨宝 mò'bǎo  
 beautiful handwriting or painting  
 墨盒 mò'hé  
 ink box  
 墨水 mò'shuǐ  
 ink

### 末 mò

- ① tip; end ② nonessentials;  
 minor details ③ end; last stage  
 ④ powder; dust  
 末班车 mò'bān'chē  
 last bus  
 末日 mò'rì  
 end; doom  
 末尾 mò'wěi  
 end

### 摩 mó

- ① rub; scrape; touch ② mull  
 over; study  
 摩登 mó'dēng  
 modern; fashionable  
 摩丝 mó'sī  
 mousse  
 摩天大楼 mó'tiān'dà'lóu  
 skyscraper

### 磨 mó

- ① rub; wear ② grind; polish  
 ③ dawdle; waste time  
 磨光 mó'guāng  
 polish  
 磨合 mó'hé  
 break in; run in  
 磨损 mó'sǔn  
 wear and tear

### 某 mǒu

- certain; some  
 某某 mǒu'mǒu  
 so-and-so  
 某人 mǒu'rén  
 somebody; someone  
 某种 mǒu'zhǒng  
 certain; a kind of

### 谋 móu

- ① stratagem; plan; scheme  
 ② seek; plot ③ consult  
 谋反 móu'fǎn  
 plot a rebellion  
 谋杀 móu'shā  
 plan to kill; murder  
 谋生 móu'shēng  
 make a living

### 没 mò

- ① sink; submerge ② rise beyond  
 ③ hide ④ take possession of ⑤ till  
 the end (of one's life)  
 没顶 mò'dǐng  
 be drowned  
 没落 mò'lùo  
 decline; wane  
 没收 mò'shōu  
 confiscate; expropriate

### 漠 mò

- ① desert ② indifferent; unconcerned  
 漠不关心 mò'bù'guān'xīn  
 indifferent  
 漠然 mò'rán  
 apathetically  
 漠视 mò'shì  
 treat with indifference

### 莫 mò

- ① no one; nothing; none ② no;  
 not ③ don't  
 莫非 mò'fēi  
 most probably; could it be  
 莫过于 mò'guò'yú  
 nothing is better than  
 莫名其妙 mò'míng'qí'mào  
 be baffled; odd

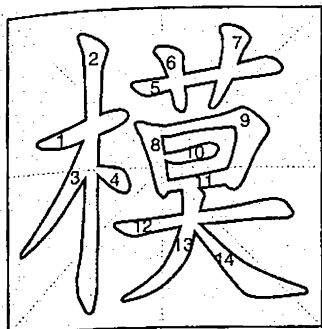

模 mú 1081

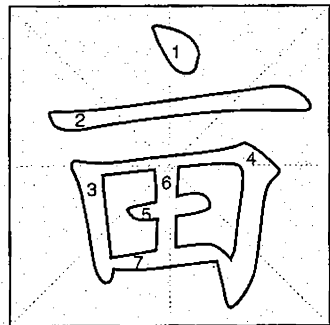

亩 mǔ 1082

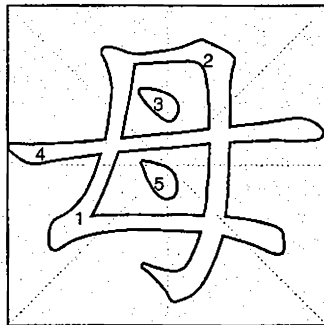

母 mǔ 1083

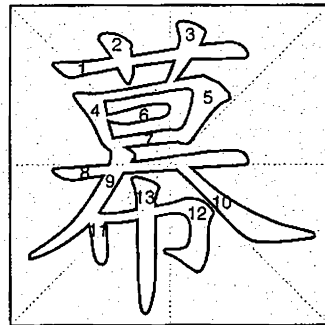

幕 mù 1084

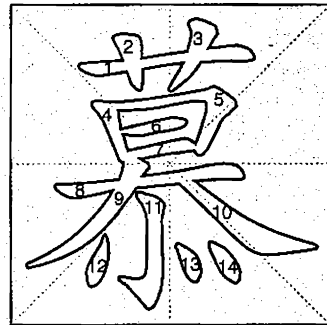

慕 mù 1085

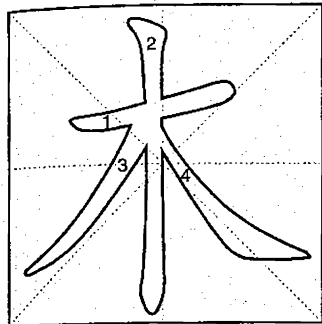

木 mù 1086

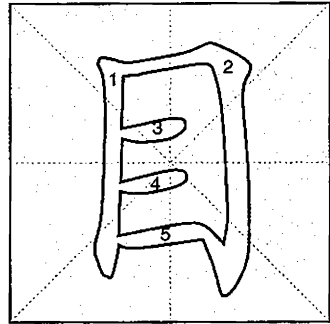

目 mù 1087

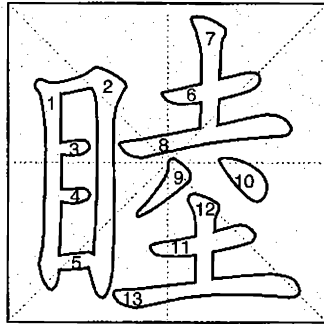

睦 mù 1088

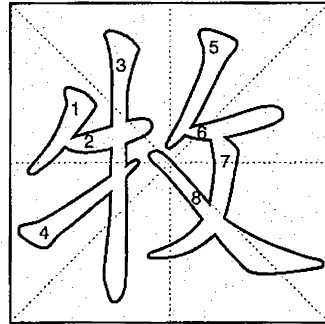

牧 mù 1089

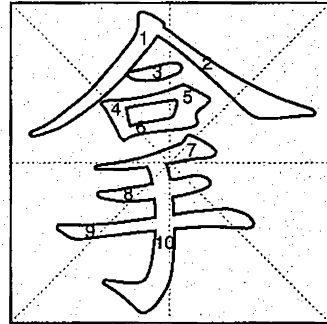

拿 ná 1090

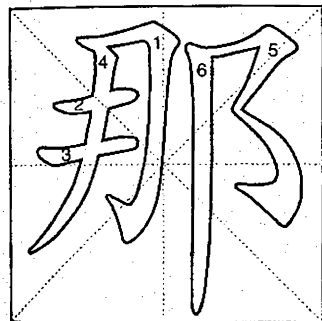

那 nà 1091

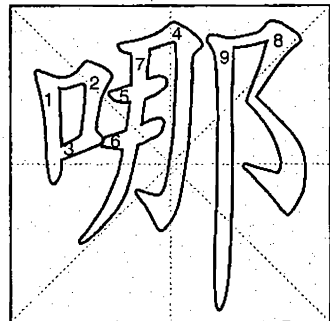

哪 nǎ 1092

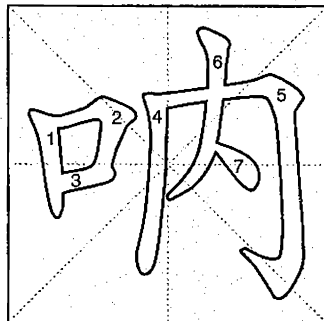

呐 nà 1093

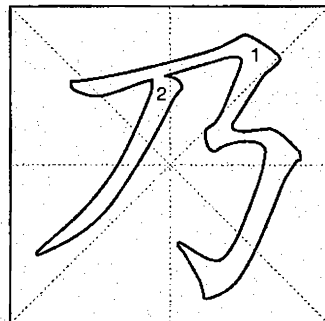

乃 nǎi 1094

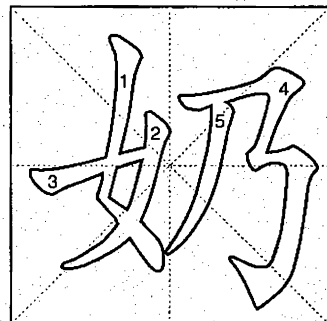

奶 nǎi 1095

### 慕 mù

admire; yearn for  
慕名 mù'míng  
out of admiration for a famous person

### 幕 mù

①curtain; screen ②act  
幕布 mù'bù  
curtain; screen  
幕后 mù'hòu  
backstage  
幕僚 mù'líáo  
aides and staff

### 母 mǔ

①mother ②one's female elders  
③female(animal)  
母爱 mǔ'ài  
maternal love  
母带 mǔ'dài  
original tape  
母语 mǔ'yǔ  
mother tongue

### 亩 mǔ

*mu*, a unit of area (=0.0667 hectares)  
亩产 mǔ'chǎn  
per *mu* yield

### 模 mú

mould; matrix; pattern; die  
模具 mú'jù  
mold; mould  
模块 mú'kuài  
mold block; module  
模样 mú'yàng  
appearance; look; about

### 拿 ná

①hold; take ②seize; capture  
③be able to do; be sure of  
拿开 ná'kāi  
take away  
拿手 ná'shǒu  
adept; expert; good at  
拿主意 ná'zhǔ'yì  
make a decision

### 牧 mù

herd; tend  
牧草 mù'cǎo  
herbage; forage grass  
牧马 mù'mǎ  
herd horses  
牧师 mù'shī  
pastor; clergyman

### 睦 mù

peaceful; harmonious  
睦邻 mù'lín  
good-neighbourliness

### 目 mù

①eye ②look; regard ③item  
④order ⑤list; catalogue  
目标 mù'biāo  
target; objective; aim  
目次 mù'cì  
contents  
目击 mù'jī  
witness

### 木 mù

①tree ②timber; wood ③made of wood; wooden ④coffin  
⑤numb; wooden  
木板 mù'bǎn  
board; plank  
木工 mù'gōng  
carpenter; woodwork  
木马 mù'mǎ  
wooden hobby horse

### 奶 nǎi

①breasts ②milk ③suckle; breastfeed  
奶粉 nǎi'fēn  
milk powder; dried milk  
奶奶 nǎi'nai  
grandma  
奶油 nǎi'yóu  
cream

### 乃 nǎi

①be ②so; therefore ③like  
then ④you; your  
乃至 nǎi'zhì  
and even

### 呐 nà

呐喊 nà'hǎn  
shout loudly; cry out

### 哪 nǎ

which; what  
哪个 nǎ'ge  
which; which one  
哪些 nǎ'xiē  
which; who; what  
那样 nǎ'yàng  
what kind of; which

### 那 nà

①that ②then  
那个 nà'ge  
that; that one  
那么 nà'me  
so; like that; in that way  
那时 nà'shí  
at that time, in those days

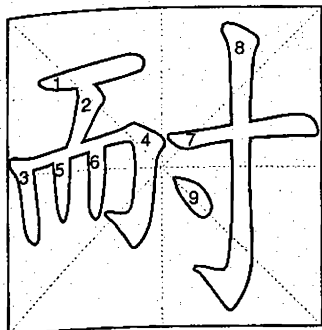

耐 nài 1096



奈 nài 1097

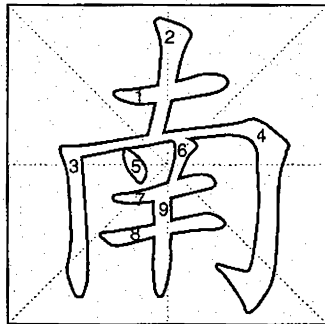

南 nán 1098

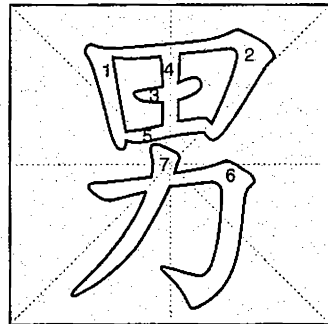

男 nán 1099

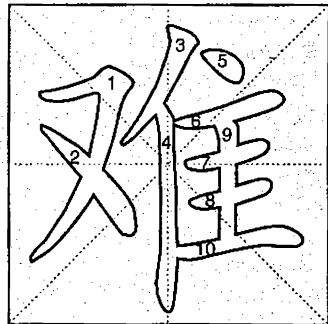

难 nán 1100

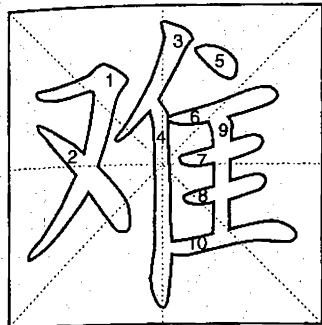

难 nàn 1101

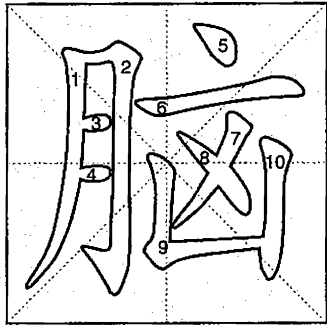

脑 nǎo 1102

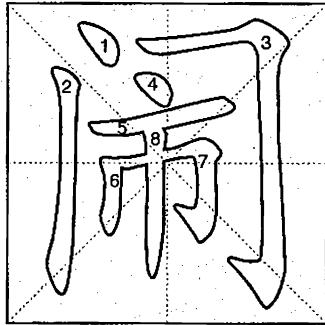

闹 nào 1103

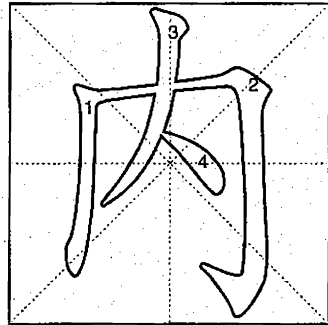

内 nèi 1104

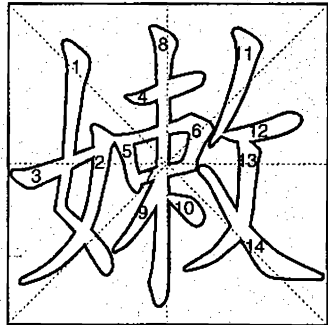

嫩 nèn 1105

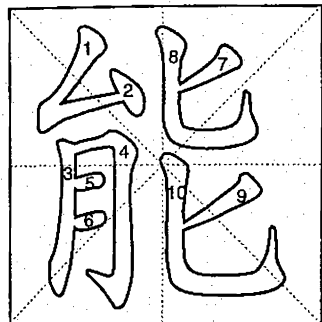

能 néng 1106

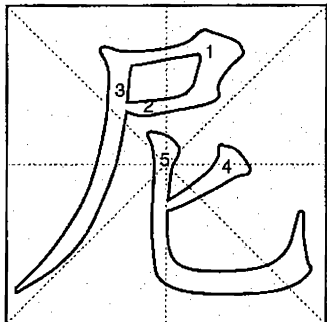

尼 ní 1107

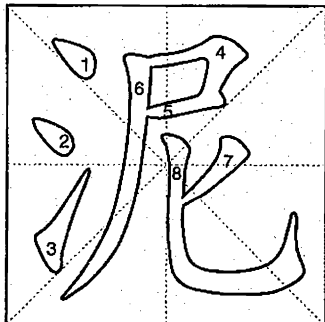

泥 ní 1108

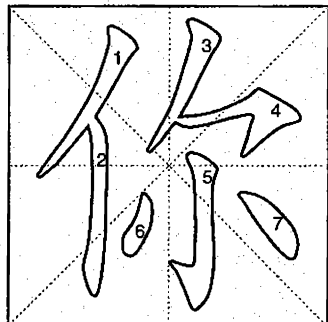

你 nǐ 1109

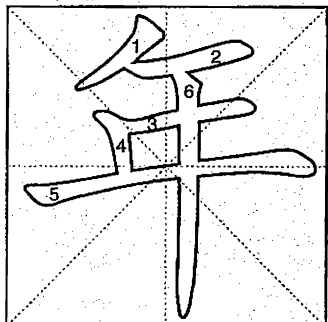

年 nián 1110



**难 nán**

- ①difficult; hard; troublesome  
 ②put sb. into a difficult position  
 ③hardly possible ④bad; unpleasant  
 难处 nán'chù  
 difficulties; troubles  
 难过 nán'guò  
 have a hard time; feel very sorry  
 难忘 nán'wàng  
 unforgettable; memorable

**男 nán**

- ①man; male ②son; boy  
 男朋友 nán'péng'yǒu  
 boyfriend  
 男士 nán'shì  
 man; gentleman  
 男性 nán'xìng  
 male

**南 nán**

- south  
 南瓜 nán'guā  
 pumpkin  
 南极 nán'jí  
 the South Pole  
 南亚 nán'yà  
 South Asia

**奈 nài**

- 奈何 nài'hé  
 how; to no avail

**耐 nài**

- be able to bear or endure  
 耐火 nài'huǒ  
 fire-resistant; refractory  
 耐久 nài'jiǔ  
 lasting long, durable  
 耐心 nài'xīn  
 patient

**嫩 nèn**

- ①tender; delicate ②light  
 ③inexperienced; unskilled  
 嫩绿 nèn'lǜ  
 light green

**内 nèi**

- ①inner; within; inside ②one's  
 wife or her relatives  
 内存(计) nèi'cún(jì)  
 internal memory  
 内地 nèi'dì  
 inland; interior  
 内行 nèi'háng  
 expert

**闹 nào**

- ①noisy ②make a noise; stir up  
 trouble ③give vent(to one's anger,  
 resentment, etc.)  
 闹市 nào'shì  
 busy streets  
 闹着玩 nào'zhe'wán  
 joke  
 闹钟 nào'zhōng  
 alarm clock

**脑 nǎo**

- brain  
 脑充血 nǎo'chōng'xuè  
 encephalemia  
 脑海 nǎo'hǎi  
 brain; mind  
 脑力劳动 nǎo'lì'láo'dòng  
 mental work

**难 nàn**

- ①calamity; disaster; adversity  
 ②take to task  
 难民 nàn'mín  
 refugee  
 难兄难弟 nàn'xiōng'nàn'dì  
 fellow sufferers  
 难友 nàn'yǒu  
 fellow sufferer

**年 nián**

- ①year ②annual; yearly ③age  
 ④New Year ⑤a period in one's  
 life ⑥a period in history  
 ⑦harvest  
 年报 nián'bào  
 annual report  
 年纪 nián'jì  
 age  
 年薪 nián'xīn  
 yearly salary

**你 nǐ**

- you  
 你好 nǐ'hǎo  
 how are you  
 你们 nǐ'men  
 you  
 你自己 nǐ'zì'jǐ  
 yourself

**泥 ní**

- ①mud; mire  
 ②mashed vegetable or fruit  
 泥巴 ní'bā  
 mud; earth  
 泥沙 ní'shā  
 silt  
 泥土 ní'tǔ  
 earth; soil; clay

**尼 ní**

- Buddhist nun  
 尼庵 ní'ān  
 Buddhist nunnery  
 尼姑 ní'gū  
 Buddhist nun  
 尼龙 ní'lóng  
 nylon

**能 néng**

- ①ability; capability; skill  
 ②energy ③able; capable ④can;  
 be able to  
 能够 néng'gòu  
 be able to; can  
 能力 néng'lì  
 ability; capability  
 能源 néng'yuán  
 energy resources

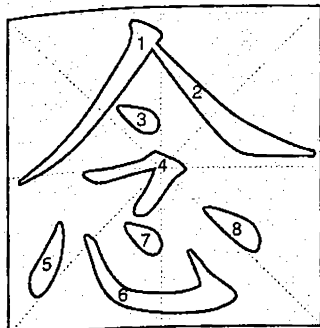

念 niàn 1111

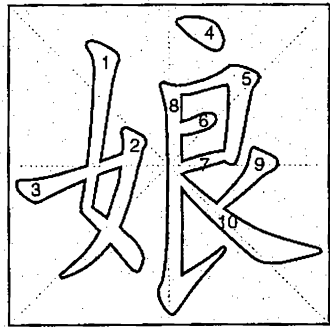

娘 niáng 1112

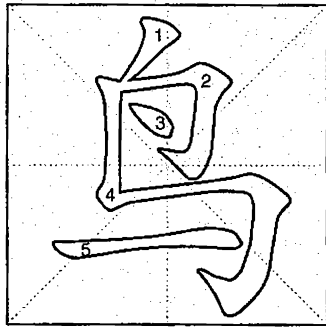

鸟 niǎo 1113

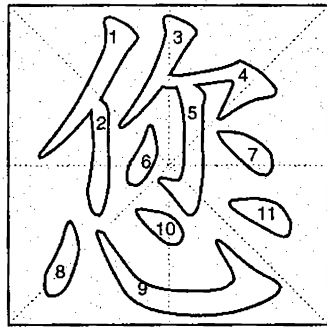

您 nín 1114

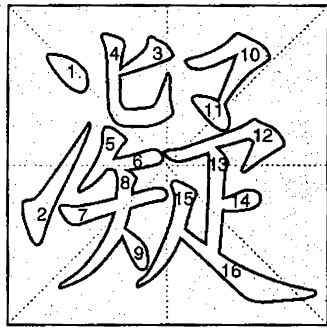

凝 níng 1115

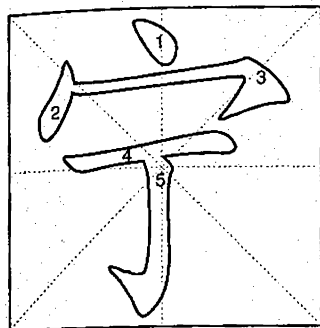

宁 níng 1116

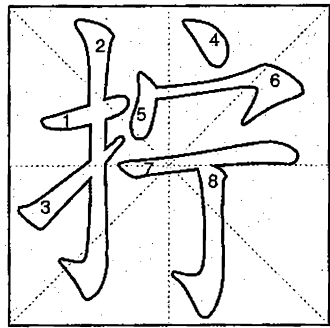

拧 níng 1117

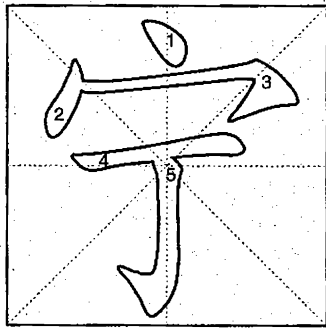

宁 nìng 1118

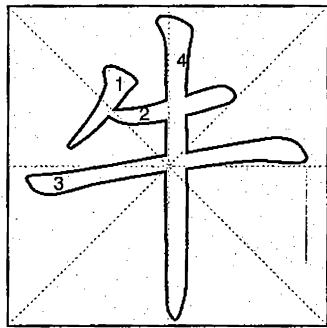

牛 niú 1119

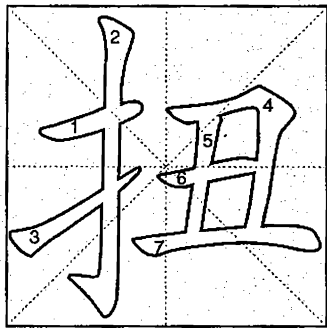

扭 niǔ 1120

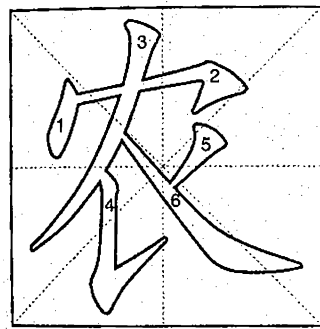

农 nóng 1121

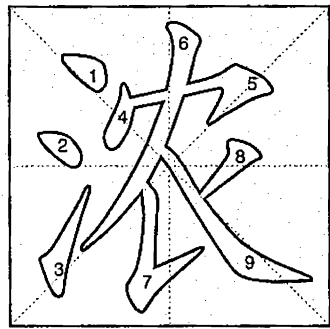

浓 nóng 1122

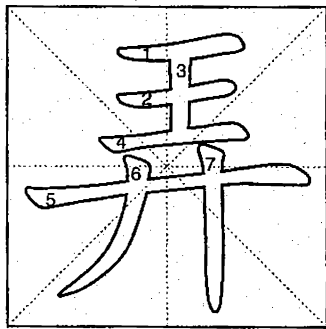

弄 nòng 1123

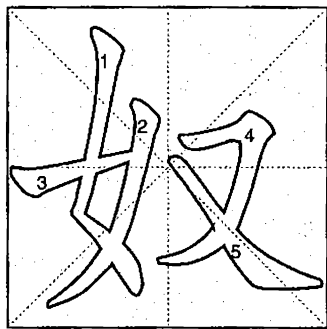

奴 nú 1124

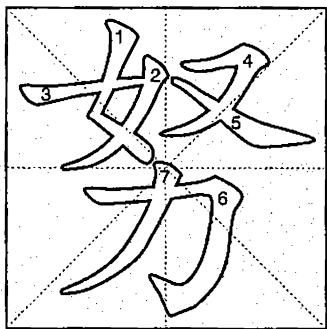

努 nǔ 1125

**凝 níng**

- ① congeal; curdle; coagulate  
② with fixed attention

凝冻 níng'dòng  
coagulate; freeze

凝固 níng'gù  
solidify

凝视 níng'shì  
watch intensively; stare

**您 nín**

(敬) you; your

**鸟 niǎo**

bird  
鸟巢 niǎo'cháo  
bird's nest  
鸟类 niǎo'lèi  
birds  
鸟笼 niǎo'lóng  
birdcage

**娘 niáng**

ma; mother  
娘家 niáng'jiā  
a married woman's parents' home  
娘胎 niáng'tāi  
mother's womb  
娘子军 niáng'zǐ'jūn  
detachment of women

**念 niàn**

① think of; miss ② thought; idea  
③ read aloud ④ study; attend school  
念叨 niàn'dao  
always talking about  
念书 niàn'shū  
study or read  
念头 niàn'tou  
idea; thought

**扭 niǔ**

- ① turn round ② twist; wrench  
③ sprain ④ roll; swing ⑤ seize;

grapple with  
扭干 niǔ'gān  
wring dry

扭伤 niǔ'shāng  
wrench

扭头 niǔ'tóu  
turn about

**牛 niú**

cattle  
牛虹 niú'máng  
gadfly  
牛奶 niú'nǎi  
milk  
牛排 niú'pái  
beefsteak

**宁 nìng**

rather; better  
宁可 nìng'kě  
would rather; prefer  
宁肯 nìng'kěn  
would rather  
宁死不屈 nìng'sǐ'bù'qū  
rather die than submit

**拧 níng**

- ① wring ② pinch; tweak

**宁 níng**

peaceful; tranquil  
宁静 níng'jìng  
tranquil; quiet  
宁日 níng'rì  
peaceful day

**努 nǔ**

- ① put forth (strength); exert (effort)

② protrude; bulge

努力 nǔ'li  
strive; great efforts

努嘴 nǔ'zuǐ  
pout one's lips as a signal

**奴 nú**

① bondservant; slave ② enslave  
奴隶 nú'lì  
slave  
奴仆 nú'pú  
servant; lackey  
奴役 nú'yì  
enslave; keep in bondage

**弄 nòng**

① play with; fool with ② do; manage; handle ③ get; fetch ④ play  
弄错 nòng'cuò  
make a mistake  
弄清 nòng'qīng  
make clear; find out  
弄脏 nòng'zāng  
stain; soil; pollute

**浓 nóng**

① dense; thick; concentrated  
② great; strong  
浓茶 nóng'chá  
strong tea  
浓度 nóng'dù  
density; concentration  
浓眉 nóng'méi  
thick eyebrows

**农 nóng**

① agriculture; farming  
② peasant; farmer  
农场 nóng'chǎng  
farm  
农民 nóng'mín  
peasant  
农田 nóng'tián  
farmland; cropland

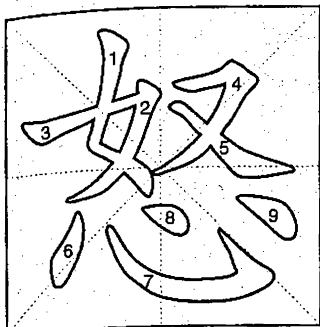

怒 nù 1126

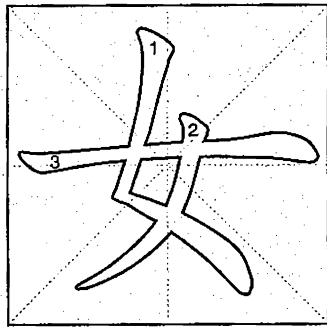

女 nǚ 1127

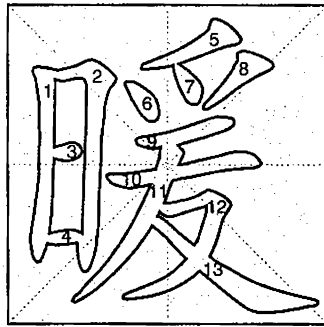

暖 nuǎn 1128

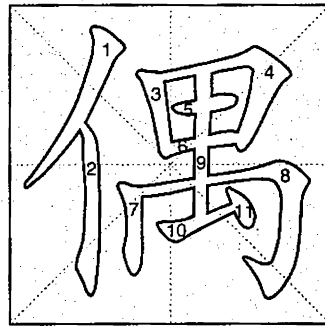

偶 ǒu 1129

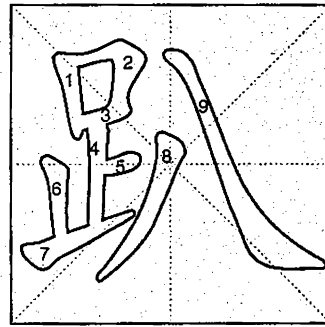

趴 pā 1130

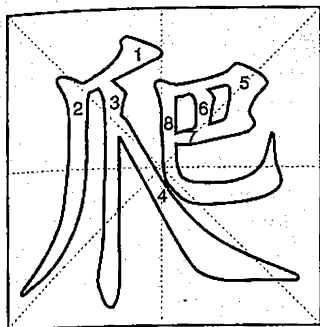

爬 pá 1131

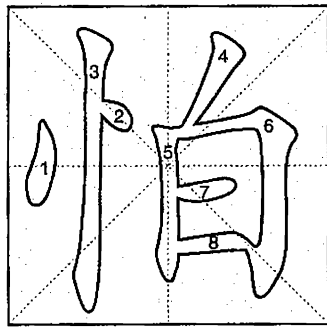

怕 pà 1132

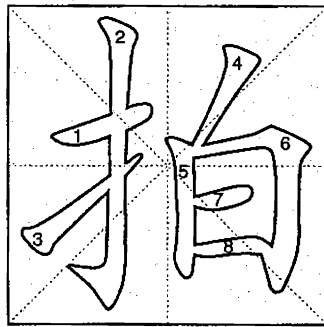

拍 pāi 1133

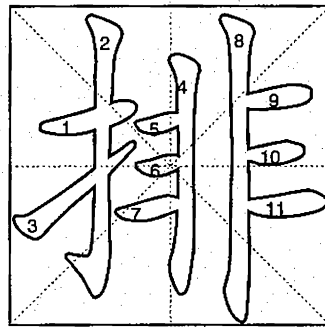

排 pái 1134

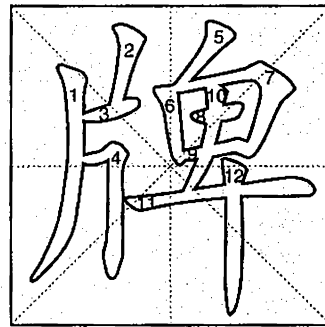

牌 pái 1135

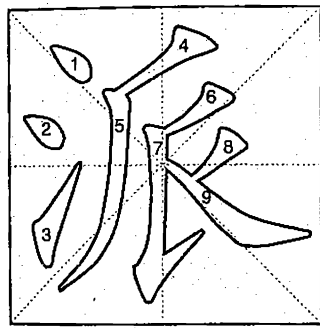

派 pài 1136

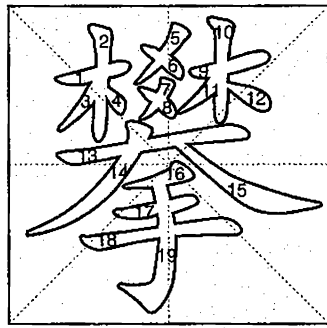

攀 pān 1137

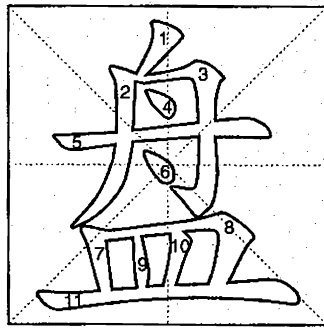

盘 pán 1138

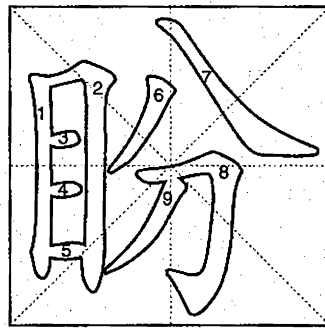

盼 pàn 1139

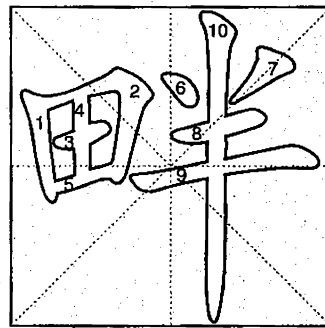

畔 pàn 1140

### 趴 pā

- ① lie on one's stomach; lie prone  
② bend over; lean on

### 偶 ǒu

- ① image; idol ② even (number); in pairs ③ mate ④ by chance; by accident; occasionally  
偶然 ǒu'rán  
accidental; fortuitous  
偶数 ǒu'shù  
even number  
偶像 ǒu'xiàng  
image; idol

### 暖 nuǎn

- ① warm; genial ② warm up  
暖冬 nuǎn'dōng  
warm winter  
暖壶〈水瓶〉 nuǎn'hú〈shuǐ'píng〉  
thermos flask  
暖洋洋 nuǎn'yáng'yáng  
warm; warmful

### 女 nǚ

- ① woman; female ② daughter;  
girl  
女儿 nǚ'ér  
daughter  
女孩 nǚ'hái  
girl  
女朋友 nǚ'péng'yǒu  
girl friend

### 怒 nù

- anger; rage; fury  
怒号〈吼〉 nù'háo〈hǒu〉  
howl; roar  
怒火 nù'huǒ  
flames of fury  
怒骂 nù'mà  
curse furiously

### 牌 pái

- ① plate; tablet ② brand  
③ cards, dominoes, etc.  
牌坊 pái'fāng  
memorial archway  
牌价 pái'jià  
list price  
牌照 pái'zhào  
license plate; license tag

### 排 pái

- ① arrange; put in order ② row;  
line ③ rehearse ④ raft ⑤ exclude;  
eject; discharge  
排版〈印〉 pái'bǎn〈yìn〉  
typesetting  
排斥 pái'chì  
repel; exclude; reject  
排污 pái'wū  
discharge waste water and other  
pollutants

### 拍 pāi

- ① clap; pat; beat ② bat; racket  
③ beat; time ④ take (a picture);  
shoot ⑤ send (a telegram, etc.)  
拍马屁 pāi'mǎ'pì  
lick sb.'s boots  
拍手 pāi'shǒu  
clap one's hands  
拍照 pāi'zhào  
take a photo

### 怕 pà

- ① fear; dread; be afraid of ② I'  
m afraid; I suppose; perhaps  
怕人 pà'rén  
shy; timid; terrible  
怕死 pà'sǐ  
fear death  
怕羞 pà'xiū  
coy; shy; bashful

### 爬 pá

- ① crawl; creep ② climb; clamber;  
scramble  
爬山虎 pá'shān'hǔ  
creeper; Boston ivy  
爬升 pá'shēng  
climb  
爬行动物 pá'xíng'dòng'wù  
reptile; creeper

### 畔 pàn

- ① side; bank ② the border of a  
field  
河畔 hé'pàn  
river bank

### 盼 pàn

- ① hope for; long for; expect  
② look  
盼头 pàn'tóu  
good prospects  
盼望 pàn'wàng  
hope for; long for

### 盘 pán

- ① tray; plate ② coil; wind; twist  
③ build ④ check; examine ⑤ game;  
set ⑥ coil  
盘活 pán'huó  
revitalize  
盘问 pán'wèn  
cross-examine  
盘子 pán'zi  
dish; plate

### 攀 pān

- ① climb; clamber ② seek  
connections in high places  
③ involve; implicate (sb. in a crime)  
攀比 pān'bǐ  
vying; compete  
攀登 pān'dēng  
climb; scale  
攀升 pān'shēng  
climb up; increase

### 派 pài

- ① group; school; faction; clique  
② style; manner and air ③ send;  
dispatch; assign; appoint  
派别 pài'bié  
group; school; faction  
派对 pài'duì  
party  
派发 pài'fā  
distribute

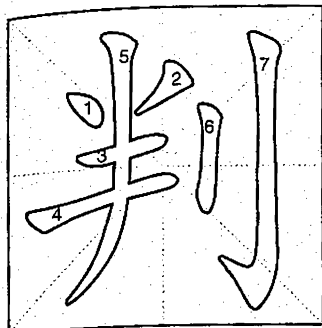

判 pàn 1141

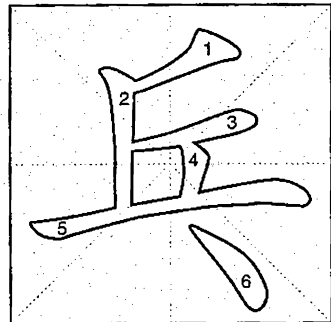

兵 bīng 1142

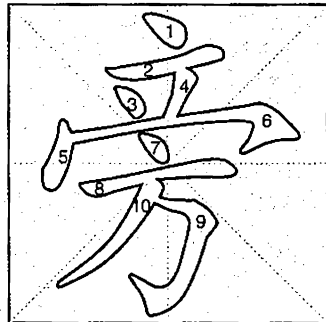

旁 páng 1143

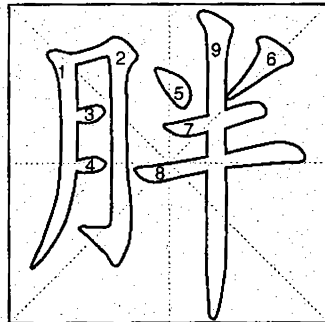

胖 pàng 1144



抛 pāo 1145

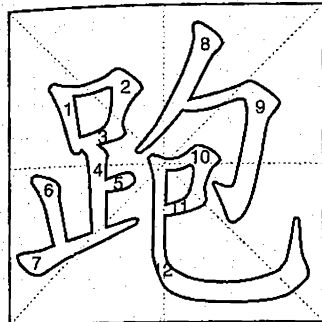

跑 pǎo 1146

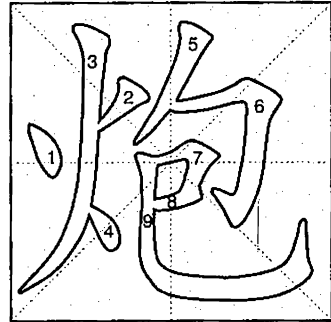

炮 pào 1147

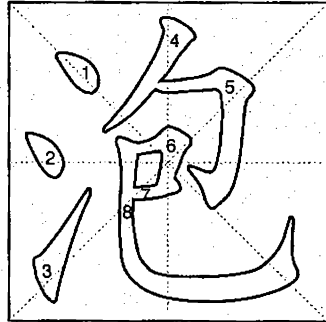

泡 pào 1148

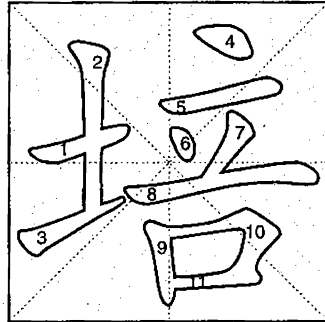

培 péi 1149

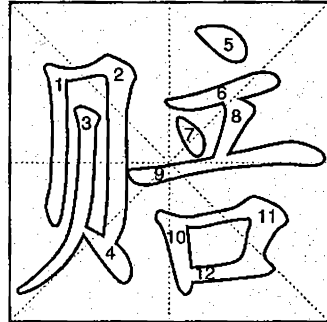

赔 péi 1150

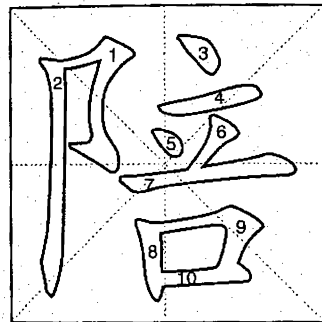

陪 péi 1151

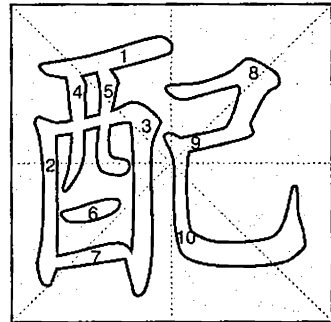

配 pèi 1152

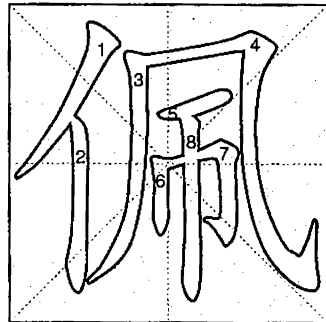

佩 pèi 1153

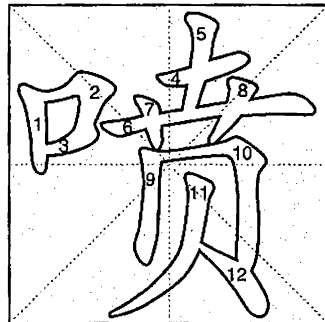

喷 pēn 1154



盆 pén 1155

### 抛 pāo

①throw; cast; toss; fling ②leave behind; cast aside  
 抛光 pāo'guāng  
 polishing; buffing  
 抛弃 pāo'qì  
 abandon; forsake  
 抛售 pāo'shòu  
 sell in big quantities

### 胖 pàng

fat; stout; plump  
 胖乎乎 pàng'hū'hū  
 plump; chubby; pudgy  
 胖头鱼 pàng'tóu'yú  
 bighead  
 胖子 pàng'zi  
 fat person; fatty

### 旁 páng

①side ②other; else  
 旁边 páng'biān  
 side  
 旁门 páng'mén  
 side door  
 旁证 páng'zhèng  
 circumstantial evidence

### 乒 pīng

乒乓球 pīng'pāng'qiú  
 table tennis

### 判 pàn

①distinguish; discriminate  
 ② obviously different ③ judge; decide ④sentence; condemn  
 判定 pàn'dìng  
 judge; decide; determine  
 判决 pàn'jué  
 court decision  
 判刑 pàn'xíng  
 sentence sb. to

### 赔 péi

①compensate; pay for ②stand a loss  
 赔本 péi'běn  
 sustain losses in business  
 赔不是 péi'bù'shi  
 apologize  
 赔罪 péi'zuì  
 apologize

### 培 péi

①bank up with earth; earth up (the roots, etc.) ②cultivate; foster  
 培训 péi'xùn  
 cultivate; train  
 培训班 péi'xùn'bān  
 training class  
 培养 péi'yǎng  
 foster; train; develop

### 泡 pào

①bubble ②sth. shaped like a bubble ③steep; soak ④dawdle  
 泡菜 pào'cài  
 pickles  
 泡茶 pào'chá  
 infuse tea; make tea  
 泡泡糖 pào'pào'táng  
 bubble gum

### 炮 pào

big gun; cannon; artillery piece  
 炮楼 pào'lóu  
 blockhouse  
 炮手 pào'shǒu  
 gunner

### 跑 pǎo

①run ②run away; escape; flee  
 ③run about doing sth.; run errands  
 ④away; off  
 跑步 pǎo'bù  
 run  
 跑车 pǎo'chē  
 racing bike  
 跑道〈航空〉 pǎo'dào〈háng'kōng〉  
 runway

### 盆 pén

basin; tub; pot  
 盆地 pén'dì  
 basin  
 盆景 pén'jǐng  
 potted landscape  
 盆栽 pén'zāi  
 grown in a pot

### 喷 pēn

①spot; gush ②spray; sprinkle  
 喷气式飞机 pēn'qì'shì'fēijī  
 jet plane  
 喷泉 pēn'quán  
 fountain  
 喷雾器 pēn'wù'qì  
 sprayer; atomiser

### 佩 pèi

①wear(at the waist, etc.)  
 ②admire  
 佩带 pèi'dài  
 wear  
 佩服 pèi'fú  
 admire  
 佩剑 pèi'jiàn  
 saber; sabre

### 配 pèi

① join in marriage ② mate (animals) ③ compound; mix ④ apportion ⑤ find sth. to fit or replace sth. else  
 配餐 pèi'cān  
 mixed food  
 配对 pèi'duì  
 pair; (of animals) mate  
 配件 pèi'jiàn  
 fittings

### 陪 péi

accompany; keep sb. company  
 陪读 péi'dú  
 keep sb. in company in his or her study  
 陪客 péi'kè  
 accompany a guest  
 陪同 péi'tóng  
 accompany

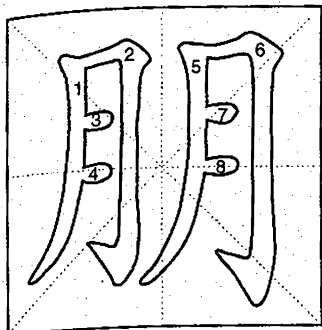

朋 péng 1156



棚 péng 1157

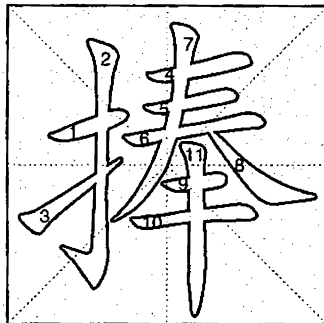

捧 pěng 1158

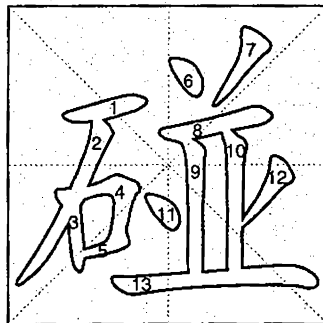

碰 pèng 1159

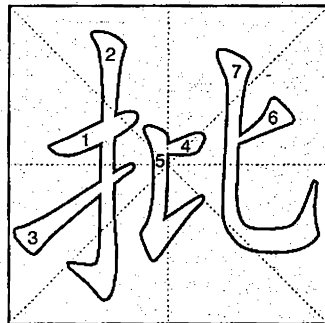

批 pī 1160

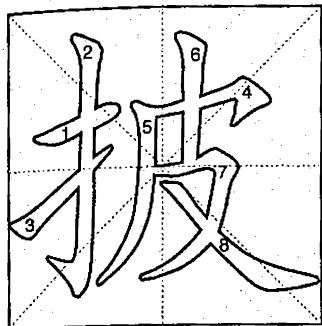

披 pī 1161

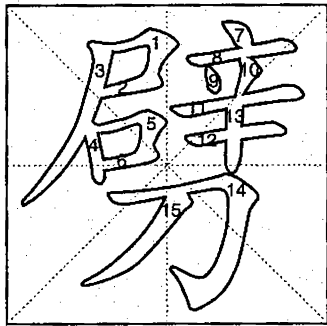

劈 pī 1162

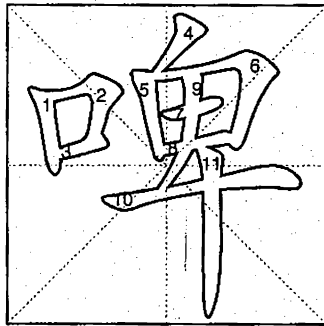

啤 pí 1163

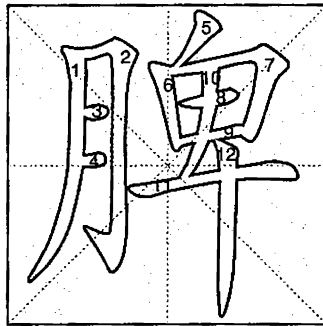

脾 pí 1164

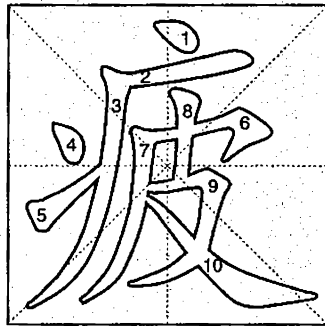

疲 pí 1165

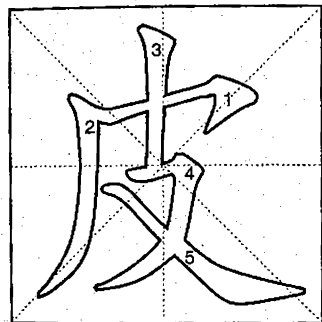

皮 pí 1166

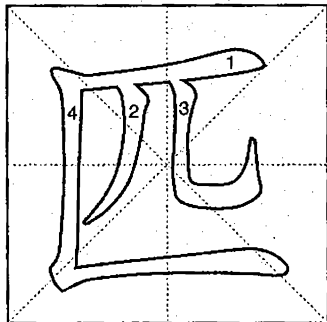

匹 pǐ 1167

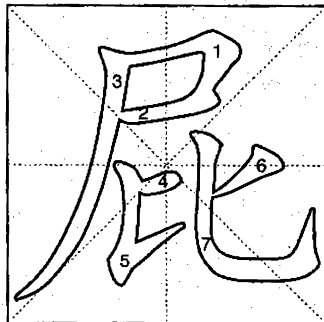

屁 pì 1168

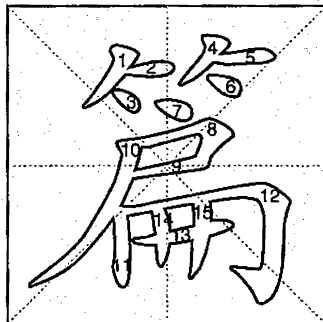

篇 piān 1169

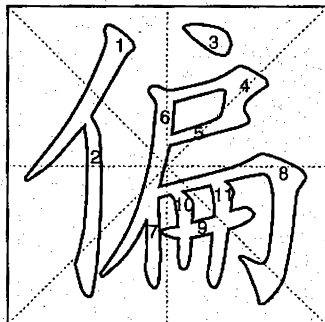

偏 piān 1170



### 批 pī

- ①slap ②criticize; refute  
 ③write comments on (a report, etc.)  
 ④wholesale ⑤batch; lot; group  
 批发 pī'fā  
 wholesale  
 批语 pī'yǔ  
 written remarks  
 批准 pī'zhǔn  
 ratify; approve; sanction

### 碰 pèng

- ①touch; bump ②meet; run into  
 ③take one's chance  
 碰杯 pèng'bēi  
 clink glasses  
 碰见 pèng'jiàn  
 meet unexpectedly  
 碰面 pèng'miàn  
 meet

### 捧 pěng

- ①hold or carry in both hands  
 ②exalt; extol  
 捧场 pěng'chǎng  
 be a member of a clique

### 棚 péng

- ①canopy of reed mats, etc.  
 ②shed; shack  
 棚户区 péng'hù'qū  
 shanty town  
 棚子 péng'zi  
 shed; shack

### 朋 péng

- friend  
 朋比为奸 péng'bǐ'wéi'jiān  
 act in collusion with  
 朋党 péng'dǎng  
 clique; cabal  
 朋友 péng'yǒu  
 friend

### 疲 pí

- tired; weary; exhausted  
 疲乏 pí'fá  
 weary; tired  
 疲倦 pí'juàn  
 weary; tired  
 疲软 pí'ruǎn  
 tired and feeble

### 脾 pí

- spleen  
 脾气 pí'qì  
 temperament  
 脾胃 pí'wèi  
 taste  
 脾脏 pí'zàng  
 spleen

### 啤 pí

- 啤酒 pí'jiǔ  
 beer  
 啤酒厂 pí'jiǔ'chǎng  
 brewery  
 啤酒馆 pí'jiǔ'guǎn  
 beer bar; beer garden

### 劈 pī

- ①split; chop; cleave  
 ②right against (one's face, chest, etc.)  
 劈头盖脸 pī'tóu'gài'liǎn  
 right in the face; direct to one's head and face

### 披 pī

- ①drape over one's shoulders; wrap around ②open; unroll; spread out ③split open; crack  
 披风 pī'fēng  
 cloak  
 披肩 pī'jiān  
 cape; shawl  
 披巾 pī'jīn  
 shawl

### 偏 piān

- ①inclined to one side; slanting  
 ②partial; prejudiced  
 偏爱 piān'ài  
 have a soft spot for sb.  
 偏方〈中医〉 piān'fāng〈zhōng'yī〉  
 folk prescription  
 偏见 piān'jiàn  
 prejudice; bias

### 篇 piān

- ①a piece of writing  
 ②sheet (of paper, etc.)  
 篇幅 piān'fú  
 length; space  
 篇目 piān'mù  
 list of articles  
 篇章 piān'zhāng  
 sections and chapters

### 屁 pì

- wind (from bowels)  
 屁股 pì'gu  
 buttocks; bottom; rump  
 屁话 pì'huà  
 nonsense

### 匹 pǐ

- be equal to; be a match for  
 匹敌 pǐ'dí  
 be equal to  
 匹夫 pǐ'fū  
 ordinary man  
 匹配 pǐ'pèi  
 mate; fit

### 皮 pí

- ①skin ②leather ③cover; wrapper 书~ book cover; jacket  
 ④surface ⑤sheet ⑥become soft and soggy  
 皮带 pí'dài  
 leather belt; belt  
 皮肤 pí'fū  
 skin  
 皮鞋 pí'xié  
 leather shoes

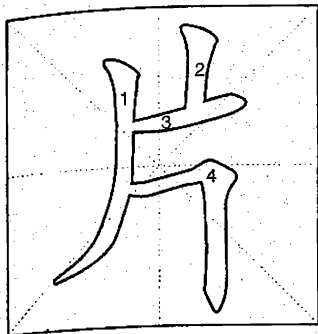

片 piàn 1171

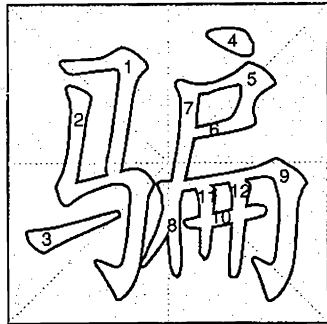

騙 piàn 1172

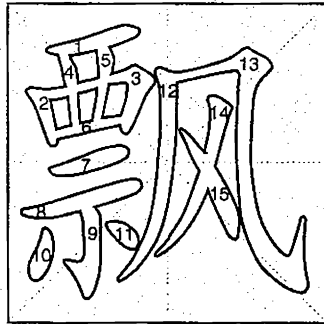

飄 piāo 1173

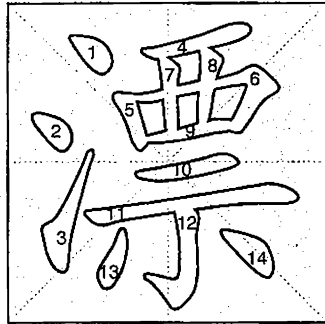

漂 piào 1174

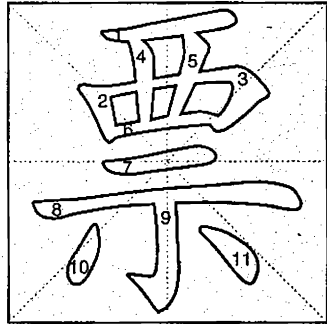

票 piào 1175

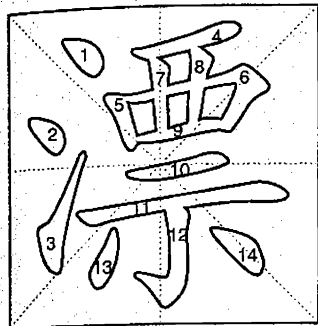

漂 piào 1176

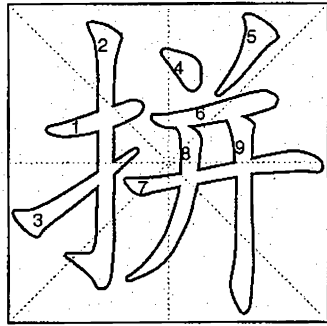

拼 pīn 1177

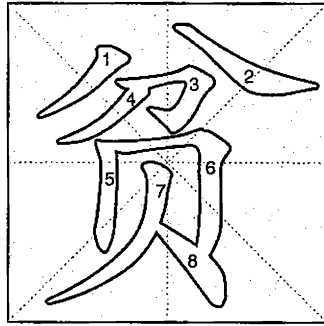

貧 pín 1178

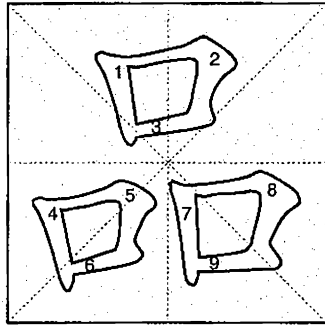

品 pǐn 1179

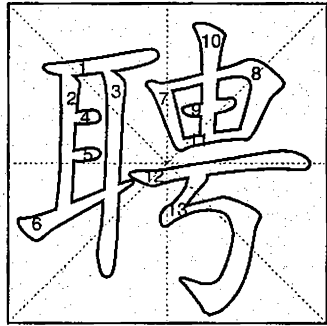

聘 pìn 1180

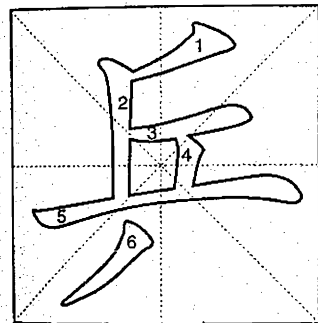

乒 pīng 1181

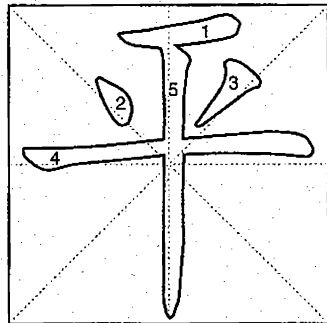

平 píng 1182

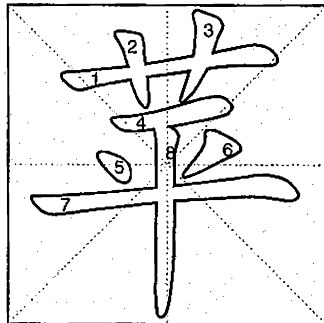

苹 píng 1183

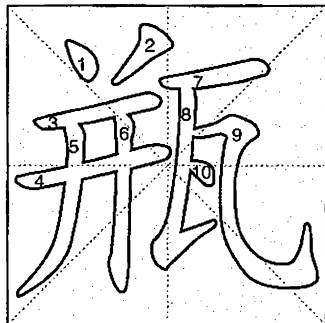

瓶 píng 1184



評 píng 1185

**票 piào**

① ticket ② ballot ③ bank note;  
bill  
票价 piào'jià  
the price of a ticket  
票据 piào'jù  
bill; note; voucher  
票子 piào'zi  
bank note; paper money

**漂 piào**

① bleach ② rinse  
漂白 piào'bái  
bleach  
漂白粉 piào'bái'fěn  
bleaching powder  
漂洗 piào'xǐ  
rinse

**飘 piāo**

wave to and fro; float (in the air);  
flutter  
飘带 piāo'dài  
streamer; ribbon  
飘动 piāo'dòng  
float (in the air); fly; flutter  
飘扬 piāo'yáng  
wave; flutter; fly

**骗 piàn**

① deceive; fool; hoodwink  
② cheat; swindle  
骗局 piàn'jú  
fraud; hoax; swindle  
骗人 piàn'rén  
deceive people  
骗子 piàn'zi  
swindler

**片 piàn**

① a flat, thin piece; slice; flake  
② part of a place ③ cut into slices  
片段 piàn'duàn  
part; passage; extract  
片剂 piàn'jì  
tablet  
片刻 piàn'kè  
a short while; an instant

**聘 pìn**

engage  
聘礼 pìn'lǐ  
betrothal gifts  
聘书 pìn'shū  
letter of appointment  
聘约 pìn'yuē  
contract of employment

**品 pǐn**

① article; product ② grade; class;  
rank ③ character; quality ④ taste;  
sample; savour  
品名 pǐn'míng  
the name of an article  
品牌 pǐn'pái  
brand (of a product)  
品质 pǐn'zhì  
character; quality

**贫 pín**

① poor; impoverished ② inadequate;  
deficient ③ loquacious  
贫困 pín'kùn  
poor; poverty  
贫穷 pín'qióng  
poor; needy  
贫血(医) pín'xuè(yī)  
anaemia

**拼 pīn**

① put together; piece together  
② be ready to risk one's life; go  
all out in work  
拼版 pīn'bǎn  
makeup  
拼写 pīn'xiě  
spell; transliterate  
拼音 pīn'yīn  
spell; phoneticize

**漂亮 piào'liàng**

handsome; beautiful

**评 píng**

① criticize; review ② judge;  
appraise  
评级 píng'jí  
grade; rate  
评价 píng'jià  
appraise; evaluate  
评奖 píng'jiǎng  
decide on awards

**瓶 píng**

bottle; jar; flask  
瓶胆 píng'dǎn  
glass liner (of a thermos flask)  
瓶盖 píng'gài  
cap  
瓶装 píng'zhuāng  
bottled  
瓶子 píng'zi  
bottle

**苹 píng**

苹果 píng'guǒ  
apple  
苹果汁 píng'guǒ'zhī  
cider

**平 píng**

① flat; level; even; smooth ② be  
on the same level; be on a par;  
equal ③ make the same score; tie;  
draw  
平均 píng'jūn  
average; mean; equally  
平米 píng'mǐ  
square meter  
平生 píng'shēng  
all one's life

**乒 pīng**

乒联 pīng'lián  
table tennis federation  
乒乓球 pīng'pāng'qiú  
table tennis  
乒协 pīng'xié  
table tennis association

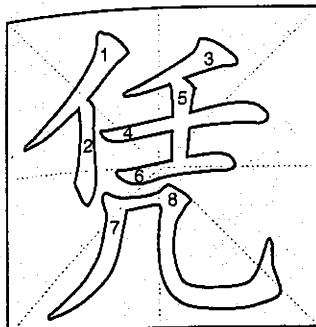

凭 píng 1186

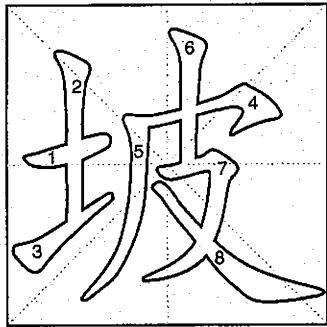

坡 pō 1187

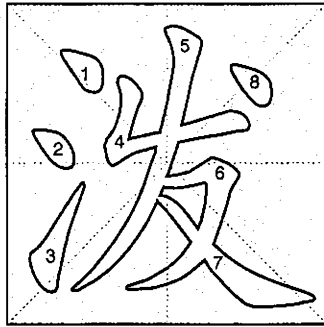

泼 pō 1188

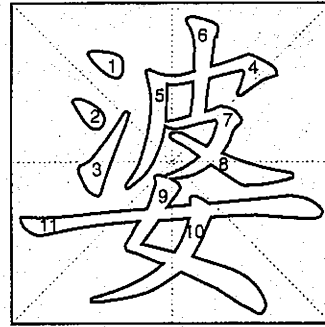

婆 pó 1189

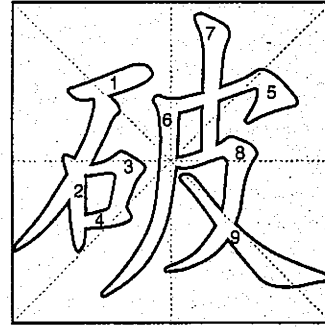

破 pò 1190

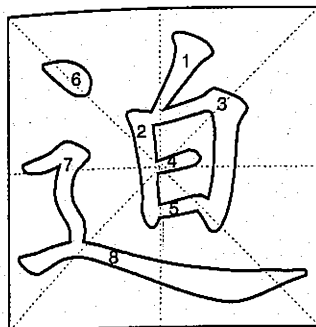

迫 pò 1191

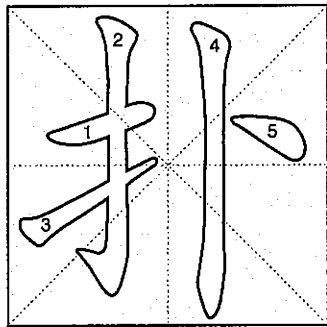

扑 pū 1192

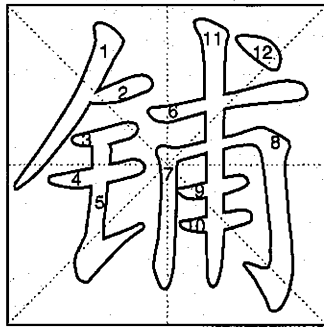

铺 pū 1193

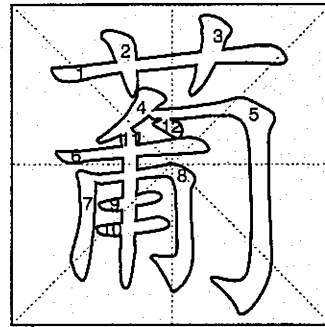

葡 pú 1194

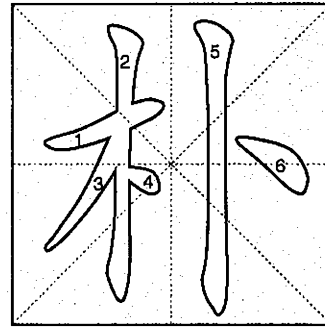

朴 pǔ 1195

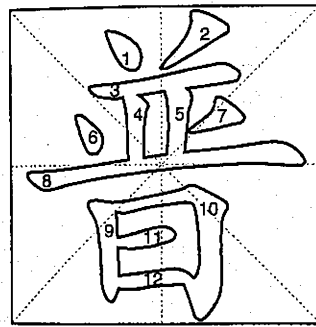

普 pǔ 1196

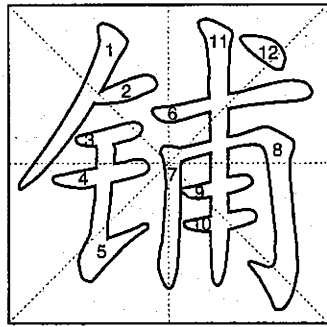

铺 pù 1197

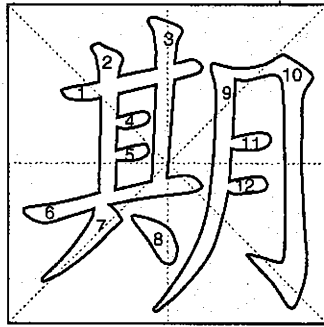

期 qī 1198

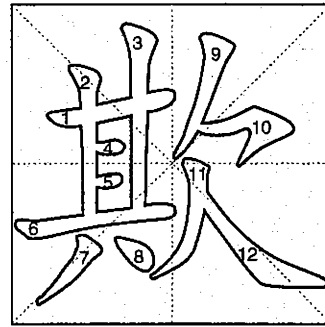

欺 qī 1199

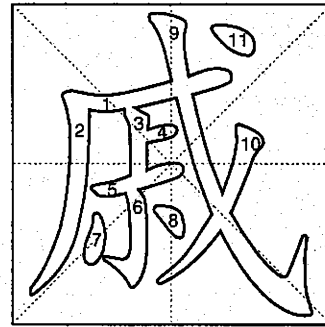

戚 qī 1200

### 破 pò

①broken; damaged; torn; worn-out  
 ②break; split; cleave; cut  
 ③get rid of; destroy; break with  
 破案 pò'àn  
 solve a case  
 破产 pò'chǎn  
 go bankrupt; fall through  
 破损 pò'sǔn  
 damaged; worn; torn

### 婆 pó

① old woman ② husband's mother; mother-in-law  
 婆家 pó'jiā  
 husband's family  
 婆婆 pó'po  
 husband's mother

### 泼 pō

①sprinkle; splash; spill ②rude and unreasonable; shrewish  
 泼冷水 pō'lěng'shuǐ  
 throw cold water on  
 泼洒 pō'sǎ  
 sprinkle; splash; spill  
 泼水节 pō'shuǐ'jié  
 the Water-Sprinkling Festival

### 坡 pō

①slope ②sloping; slanting  
 坡地 pō'dì  
 hillside fields  
 坡度 pō'dù  
 slope; gradient

### 凭 píng

①lean on; lean against ②rely on; depend on ③evidence; proof  
 ④go by; base on; take as the basis  
 凭单 píng'dān  
 a certificate; voucher  
 凭照 píng'zhào  
 permit; licence  
 凭证 píng'zhèng  
 proof; evidence

### 朴 pǔ

plain  
 朴实(素) pǔ'shí(sù)  
 simple; plain

### 葡 pú

葡萄 pú'táo  
 grape  
 葡萄糖 pú'táo'táng  
 glucose; grape sugar  
 葡萄汁 pú'táo'zhī  
 grape juice

### 铺 pū

①spread; extend; unfold ②pave; lay  
 铺床 pū'chuáng  
 make the bed  
 铺轨 pū'guǐ  
 lay a railway track  
 铺设 pū'shè  
 lay build

### 扑 pū

① throw oneself on; pounce on  
 ② rush at; attack ③ flap; flutter  
 ④ bend over  
 扑克 pū'kè  
 playing cards; poker  
 扑空 pū'kōng  
 come away empty-handed  
 扑灭 pū'miè  
 stamp out; extinguish

### 迫 pò

①compel; force; press ②urgent; pressing ③go towards  
 迫近 pò'jìn  
 approach; get close to  
 迫切 pò'qiè  
 urgent; pressing  
 迫使 pò'shǐ  
 force; compel

### 戚 qī

relative; sorrow; woe  
 亲戚朋友 qīn'qī'péng'yǒu  
 family members and friends  
 哀戚 āi'qī  
 mournful; plaintive

### 欺 qī

①deceive ②bully; take advantage of  
 欺生 qī'shēng  
 bully or cheat strangers  
 欺压 qī'yā  
 bully and oppress  
 欺诈 qī'zhà  
 cheat; swindle

### 期 qī

①a period of time; phase; stage  
 ②scheduled time  
 ③make an appointment  
 期待 qī'dài  
 expect; await  
 期刊 qī'kān  
 periodical  
 期望 qī'wàng  
 hope; expectation

### 铺 pù

①shop; store ②plank bed  
 铺板 pù'bǎn  
 bed board  
 铺面 pù'miàn  
 shop front  
 铺子 pù'zi  
 shop; store

### 普 pǔ

general; universal  
 普遍 pǔ'biàn  
 universal; general  
 普查 pǔ'chá  
 general investigation  
 普天下 pǔ'tiān'xià  
 the whole world

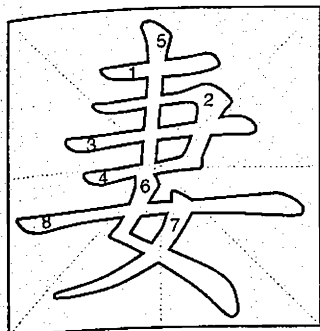

妻 qī 1201

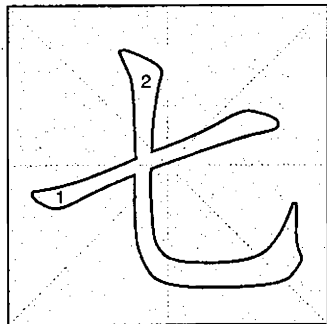

七 qī 1202

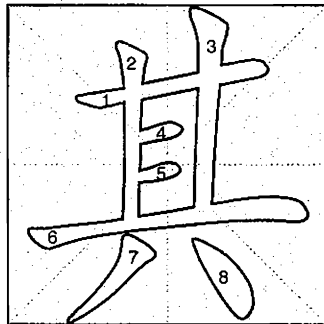

其 qí 1203

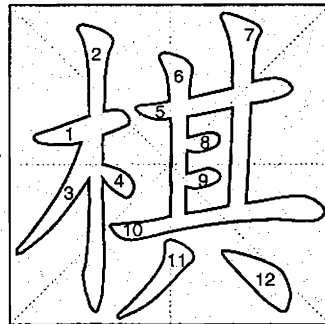

棋 qí 1204

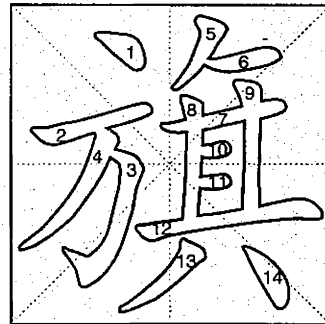

旗 qí 1205

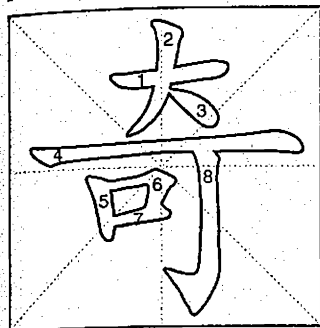

奇 qí 1206

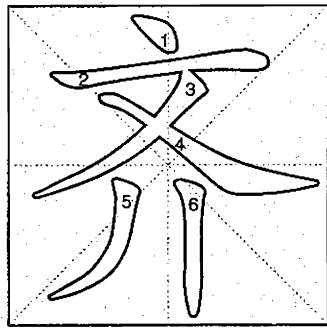

齐 qí 1207

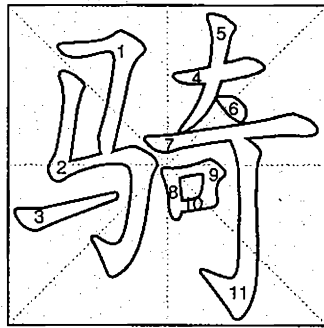

骑 qí 1208

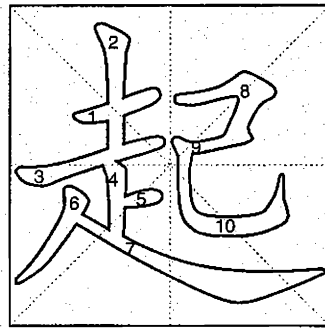

起 qǐ 1209

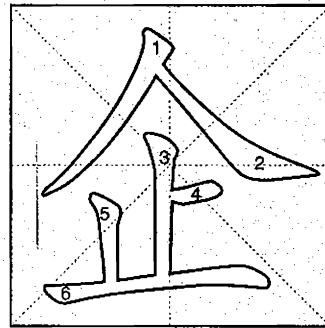

企 qǐ 1210

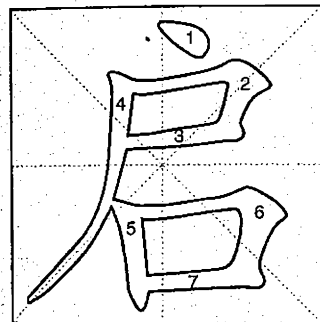

启 qǐ 1211

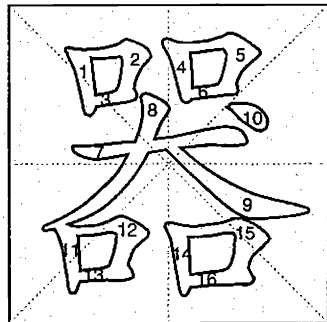

器 qì 1212

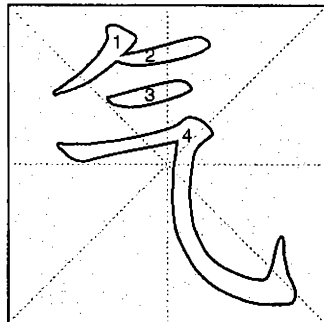

气 qì 1213

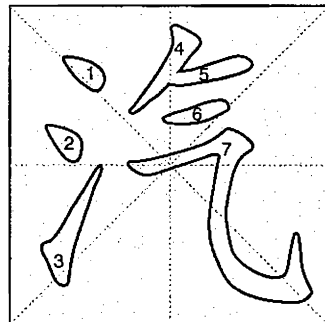

汽 qì 1214

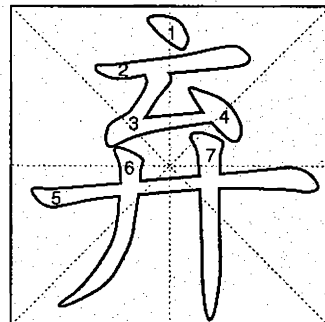

弃 qì 1215

### 旗 qí

flag; banner; standard  
 旗舰 qí'jiàn  
 flagship  
 旗帜 qí'zhì  
 banner; flag; stand  
 旗子 qí'zi  
 flag; banner; pennant

### 棋 qí

chess; 下盘 ~ play a game of chess  
 棋迷 qí'mí  
 chess fan  
 棋谱 qí'pǔ  
 chess manual  
 棋手 qí'shǒu  
 chess player

### 其 qí

①his (her; its; their) ②he (she, it, they) ③that; such  
 其实 qí'shí  
 actually; in fact  
 其余 qí'yú  
 the others; the rest  
 其中 qí'zhōng  
 among; in

### 七 qī

seven; seventh  
 七巧板 qí'qiǎo'bǎn  
 seven-piece puzzle  
 七月 qí'yuè  
 July  
 七嘴八舌 qí'zuǐ'bā'shé  
 all talking at once

### 妻 qī

wife  
 妻舅 qí'jiù  
 brother-in-law  
 妻离子散 qí'lǐ'zǐ'sàn  
 breaking up or scattering of one's family  
 妻子 qí'zi  
 wife

### 企 qǐ

①stand on tiptoe ②anxiously expect sth.; look forward to  
 企鵝 qí'ē  
 penguin  
 企图 qí'tú  
 attempt; try; seek  
 企业 qí'yè  
 enterprise; business

### 起 qǐ

①rise; get up; stand up  
 ②remove; extract; pull ③appear; raise ④rise ⑤draft; work out  
 起草 qǐ'cǎo  
 draft; draw up  
 起点 qǐ'diǎn  
 starting point  
 起飞 qǐ'fēi  
 take off

### 骑 qí

ride  
 骑兵 qí'bīng  
 cavalryman; cavalry  
 骑士 qí'shì  
 knight; cavalier  
 骑手 qí'shǒu  
 rider

### 齐 qí

①neat; even; uniform ②on a level with ③together; simultaneously ④all ready; all present  
 齐备 qí'bèi  
 be all ready  
 齐唱 qí'chàng  
 singing in unison  
 齐心 qí'xīn  
 be of one mind

### 奇 qí

①strange; queer; rare  
 ②surprise; wonder; astonish  
 奇观 qí'guān  
 marvellous spectacle  
 奇迹 qí'jì  
 miracle; wonder; marvel  
 奇效 qí'xiào  
 special effect

### 弃 qì

throw away; discard; abandon  
 弃权 qí'quán  
 abstain from voting  
 弃世 qí'shì  
 pass away; die  
 弃置 qí'zhì  
 throw aside

### 汽 qì

vapour; steam  
 汽车 qí'chē  
 automobile; car  
 汽笛 qí'dí  
 steam whistle; siren  
 汽油 qí'yóu  
 petrol; gasoline

### 气 qì

①gas ②air ③breath ④smell; odour ⑤weather ⑥airs; manner ⑦spirit; morale  
 气泡 qì'pào  
 air bubble  
 气枪 qì'qiāng  
 air gun  
 气球 qì'qiú  
 balloon

### 器 qì

①implement; utensil; ware  
 ②organ ③capacity; talent  
 器材 qì'cái  
 equipment; material  
 器官 qì'guān  
 organ; apparatus  
 器乐 qì'yuè  
 instrumental music

### 启 qǐ

①open ②start; initiate  
 ③enlighten; awaken  
 启动 qǐ'dòng  
 start; switch on; open up; come under way  
 启封 qǐ'fēng  
 unseal; break the seal  
 启航 qǐ'háng  
 set sail; weight anchor

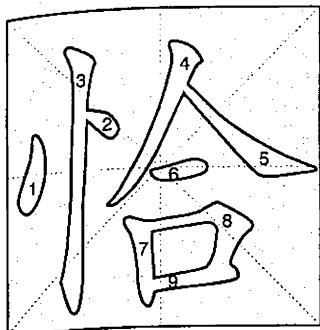

恰 qià

1216

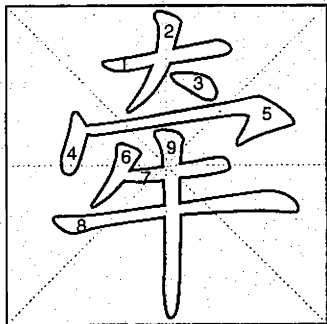

牵 qiān

1217

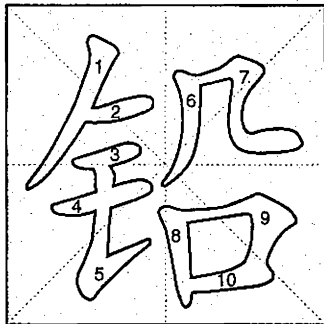

铅 qiān

1218

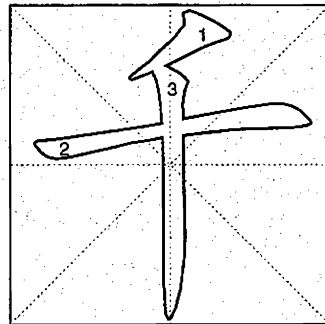

千 qiān

1219

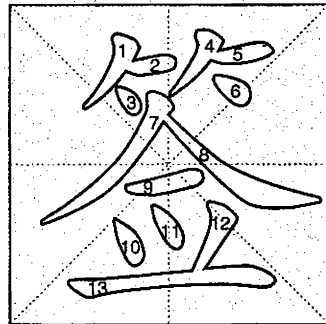

签 qiān

1220

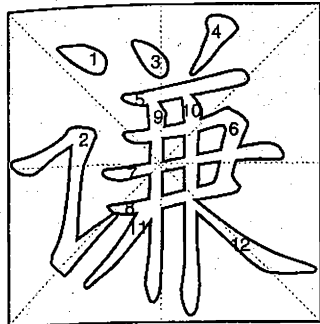

谦 qiān

1221



钱 qián

1222

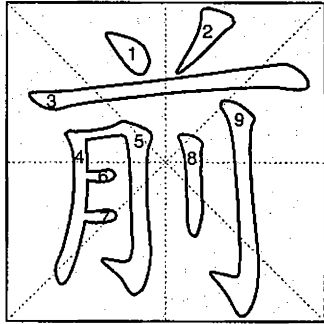

前 qián

1223

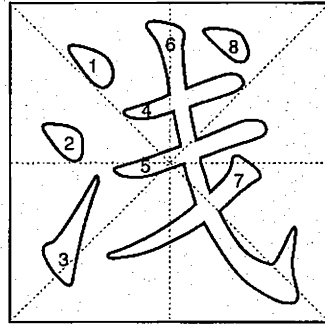

浅 qiǎn

1224

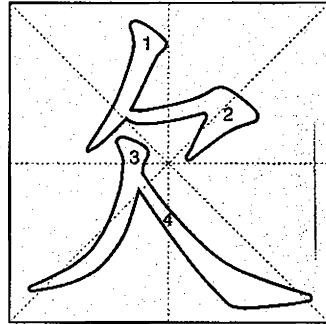

欠 qiàn

1225

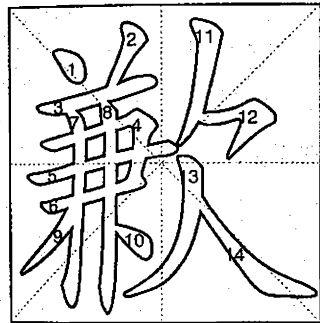

歉 qiàn

1226

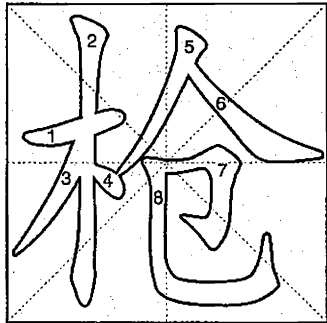

枪 qiāng

1227

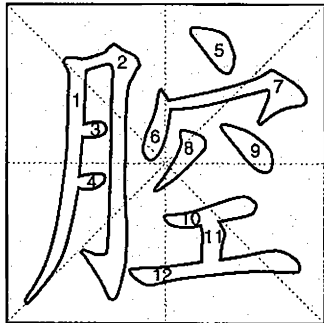

腔 qiāng

1228

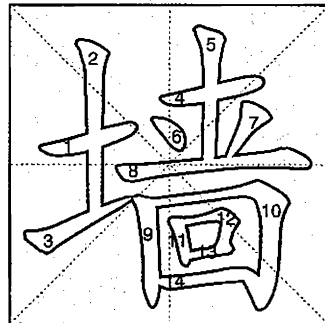

墙 qiáng

1229

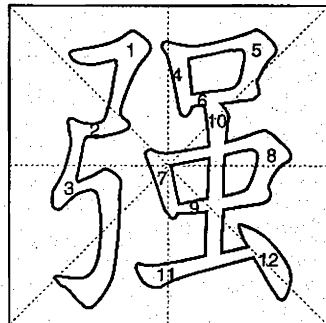

强 qiáng

1230



### 签 qiān

① sign ② make brief comments on a document ③ bamboo slips used for divination or drawing lots

签订 qiān'dìng

conclude and sign

签署 qiān'shǔ

sign

签证 qiān'zhèng

visa

### 千 qiān

① thousand ② a great amount of

千伏 qiān'fú

kilovolt(Kv.)

千瓦 qiān'wǎ

kilowatt(KW)

千万 qiān'wàn

ten million

### 铅(化) qiān(huà)

① lead (符号 Pb); ② lead; black lead

铅笔 qiān'bǐ

pencil

铅球(体) qiān'qiú(tǐ)

shot

铅字(印) qiān'zì(yìn)

type; letter

### 牵 qiān

① lead along (by holding the hand, the halter, etc.); pull

② involve

牵挂 qiān'guà

worry; care

牵涉 qiān'shè

involve; drag in

牵引 qiān'yǐn

tow; draw

### 恰 qià

① appropriate; proper ② just; exactly

恰当 qià'dàng

proper; suitable; fitting

恰到好处 qià'dào'hǎo'chù

just right

恰似 qià'sì

exactly like

### 欠 qiàn

① owe; be behind with ② not enough; lacking; wanting ③ raise slightly

欠安 qiàn'ān

fell unwell; indisposed

欠债 qiàn'zhài

be in debt; owe money

欠资(邮) qiàn'zī(yóu)

postage due

### 浅 qiǎn

① shallow ② simple; easy ③ superficial ④ not intimate; not close ⑤(of colour) light

浅色 qiǎn'sè

light colour

浅滩 qiǎn'tān

shoal; shallows

浅易 qiǎn'yì

simple and easy

### 前 qián

① front ② forward; ahead ③ ago; before ④ preceding ⑤ former; formerly ⑥ first

前途 qián'tú

future; prospect

前言 qián'yán

preface; foreword

前兆 qián'zhào

omen; forewarning

### 钱 qián

① copper coin; cash ② money ③ fund; sum ④ qian, a unit of weight (=5 grams)

钱包 qián'bāo

wallet; purse

钱币 qián'bi

coin

钱柜 qián'guì

money-box; money locker

### 谦 qiān

modest 谦让 qiān'ràng

modestly decline

谦虚 qiān'xū

modest; self-effacing

谦逊 qiān'xùn

modest; unassuming

### 强 qiáng

① strong; powerful ② by force ③ better ④ lightly more than; plus

强盗 qiáng'dào

robber; bandit

强国 qiáng'guó

powerful nation

强壮 qiáng'zhuàng

strong; sturdy; robust

### 墙 qiáng

wall

墙报 qiáng'bào

wall newspaper

墙壁 qiáng'bì

wall

墙纸 qiáng'zhǐ

wallpaper

### 腔 qiāng

① cavity ② tune; pitch

③ accent ④ speech

腔调 qiāng'diào

tune; accent

### 枪 qiāng

① rifle; gun; firearm ② spear

枪靶 qiāng'bǎ

target; mark

枪击 qiāng'jī

shoot

枪手 qiāng'shǒu

marksman; gunner

### 歉 qiàn

① apology ② crop failure

歉收 qiàn'shōu

crop failure; poor harvest

歉意 qiàn'yì

apology; regret

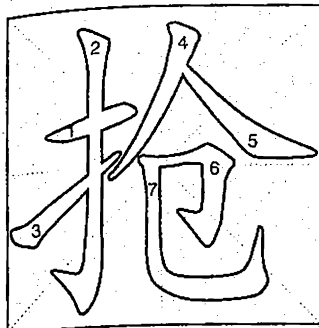

抢 qiǎng 1231

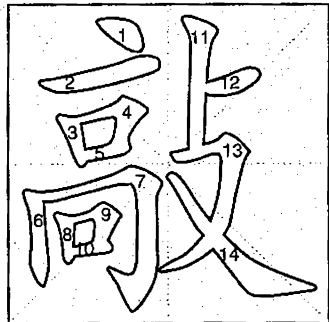

敲 qiāo 1232

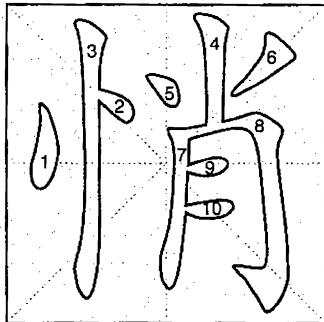

悄 qiāo 1233

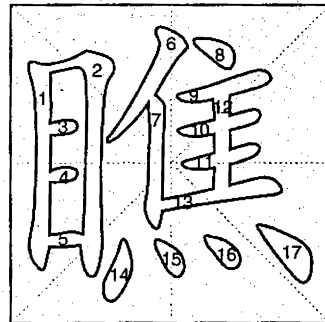

瞧 qiáo 1234

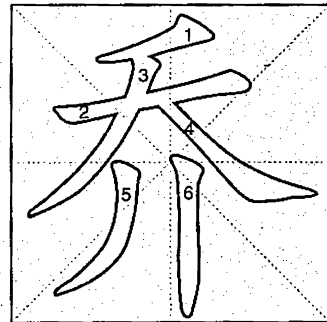

乔 qiáo 1235

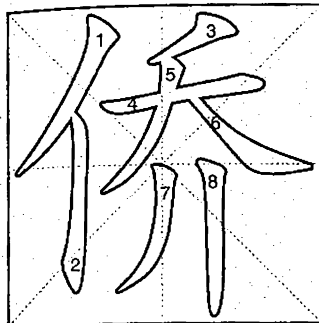

侨 qiáo 1236

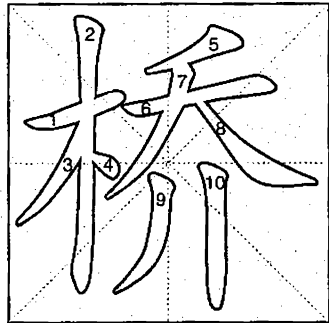

桥 qiáo 1237

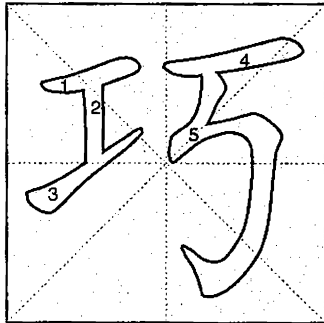

巧 qiǎo 1238

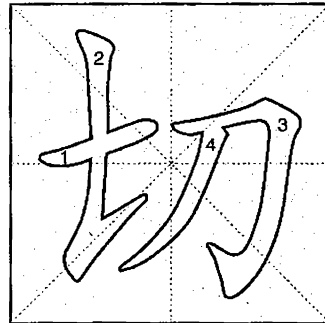

切 qiē 1239

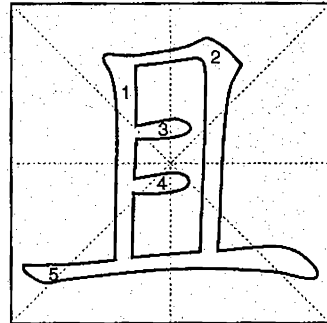

且 qiě 1240

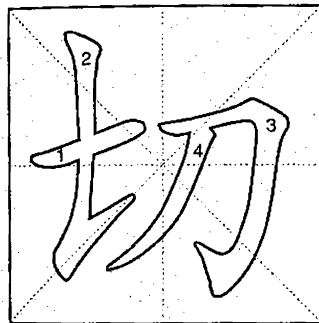

切 qiè 1241

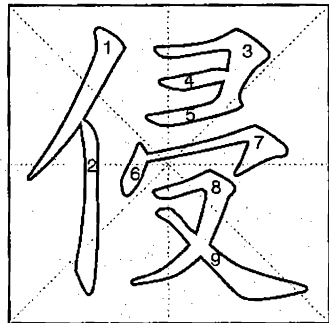

侵 qīn 1242

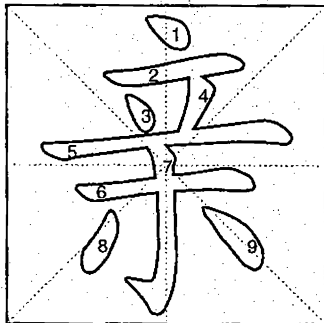

亲 qīn 1243

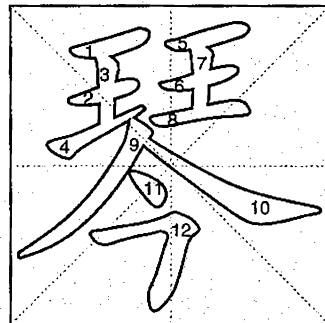

琴 qín 1244

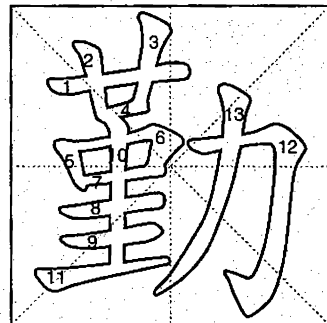

勤 qín 1245

### 乔 qiáo

①tall ②disguise  
乔木 qiáo'mù  
arbor; tree  
乔迁 qiáo'qiān  
move to a better place  
乔装 qiáo'zhuāng  
disguise; dress up

### 瞧 qiáo

look; see  
瞧不起 qiáo'bu'qǐ  
look down upon  
瞧得起 qiáo'de'qǐ  
think much of sb.  
瞧见 qiáo'jiàn  
see; catch sight of

### 悄 qiāo

悄悄 qiāo'qiāo  
quietly; on the quiet

### 敲 qiāo

knock; beat  
敲打 qiāo'dǎ  
beat; rap; tap  
敲定 qiāo'dìng  
determine  
敲诈 qiāo'zhà  
extort; blackmail

### 抢 qiǎng

①rob; ②snatch  
抢购 qiǎng'gòu  
rush to purchase  
抢劫 qiǎng'jié  
rob; loot; plunder  
抢救 qiǎng'jiù  
rescue; save; salvage

### 且 qiě

just; for the time being  
且慢 qiě'màn  
wait a moment  
且...且... qiě...qiě...  
while; as

### 切 qiē

cut; slice  
切断 qiē'duàn  
cut off  
切入 qiē'rù  
go deep into; penetrate  
切纸机 qiē'zhǐ'jī  
paper cutter

### 巧 qiǎo

①skillful; ingenious; clever  
②cunning; artful ③opportunistically;  
coincidentally; as it happens  
巧干 qiǎo'gàn  
work ingeniously  
巧克力 qiǎo'kè'lì  
chocolate  
巧妙 qiǎo'miào  
ingenious; clever

### 桥 qiáo

bridge  
桥洞 qiáo'dòng  
bridge opening  
桥拱 qiáo'gǒng  
bridge arch  
桥头 qiáo'tóu  
either end of a bridge

### 侨 qiáo

live abroad  
侨胞(qiáo'bāo) (mfn)  
countrymen residing abroad  
侨汇 qiáo'huì  
overseas remittance  
侨居 qiáo'jū  
live abroad

### 勤 qín

①diligent; industrious  
②frequently; regularly  
③attendance  
勤奋 qín'fèn  
diligent; industrious  
勤快 qín'kuài  
diligent; hardworking  
勤务 qín'wù  
duty; service

### 琴 qín

a general name for certain  
musical instruments  
琴键 qín'jiàn  
key  
琴师 qín'shī  
music master; accompanist  
琴弦 qín'xián  
string

### 亲 qīn

①parent ②blood relation; next  
of kin ③relative ④marriage;  
match ⑤close; intimate; dear  
⑥kiss  
亲王 qīn'wáng  
prince  
亲友 qīn'yǒu  
relatives and friends  
亲嘴 qīn'zuǐ  
kiss

### 侵 qīn

invade; intrude into  
侵犯 qīn'fàn  
encroach on; violate  
侵入 qīn'rù  
invade; intrude into  
侵占 qīn'zhàn  
invade and occupy; seize

### 切 qiè

①correspond to; be close to  
②eager; anxious ③be sure to  
切记 qiè'jì  
must always remember  
切忌 qiè'jì  
must guard against  
切题 qiè'tí  
keep to the point

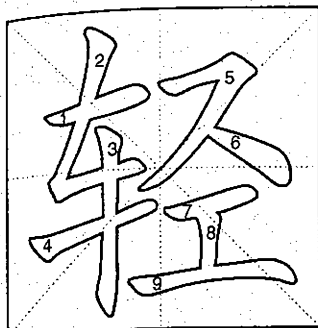

轻 qīng 1246

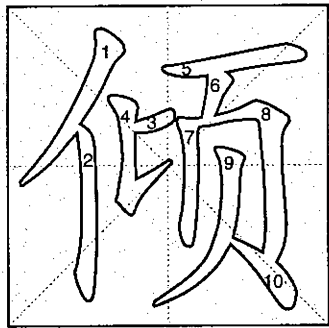

倾 qīng 1247



青 qīng 1248

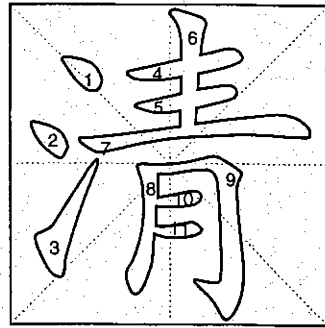

清 qīng 1249

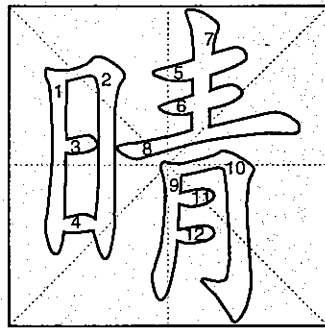

晴 qíng 1250

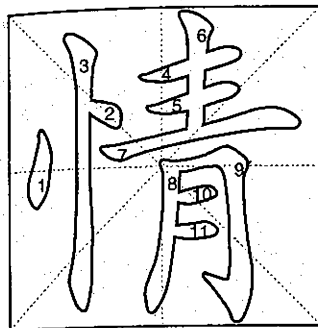

情 qíng 1251



请 qǐng 1252

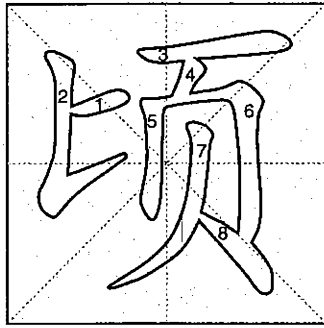

顷 qǐng 1253

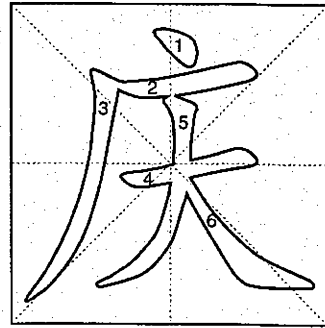

庆 qìng 1254

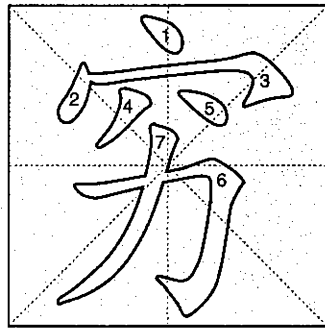

穷 qióng 1255

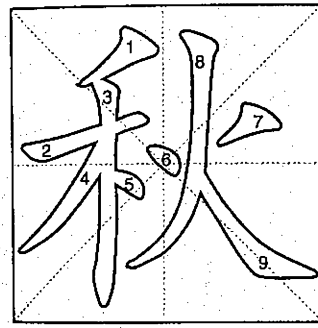

秋 qiū 1256

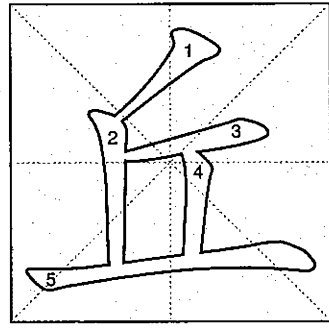

丘 qiū 1257

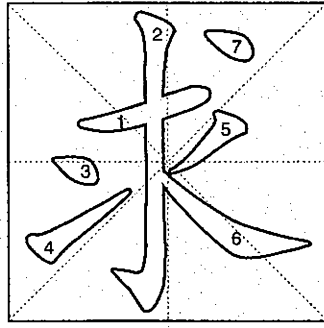

求 qiú 1258

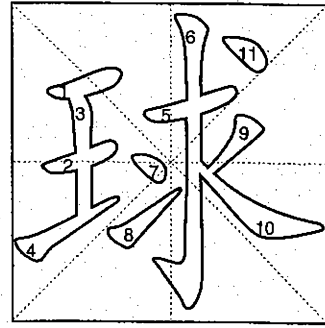

球 qiú 1259

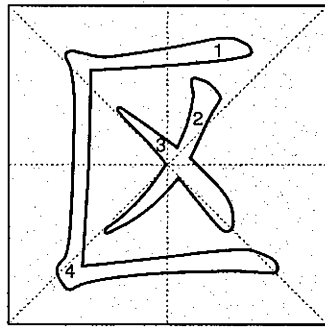

区 qū 1260

**晴 qíng**

fine; clear  
 晴空 qíng'kōng  
 clear sky; cloudless sky  
 晴天 qíng'tiān  
 fine day; sunny day  
 晴雨表 qíng'yǔ'biǎo  
 barometer

**清 qīng**

① unmixed; clear ② distinct; clarified ③ quiet ④ completely  
 ⑤ settle; clean up ⑥ count  
 清白 qīng'bái  
 pure; clean; stainless  
 清点 qīng'diǎn  
 check; make an inventory  
 清一色 qīng'yī'sè  
 all of the same color

**青 qīng**

① blue or green ② black  
 ③ green grass; young crops  
 ④ young  
 青菜 qīng'cài  
 green vegetables  
 青年 qīng'nián  
 youth; young people  
 青蛙 qīng'wā  
 frog

**倾 qīng**

① incline; lean; bend  
 ② deviation; tendency ③ collapse  
 ④ overturn and pour out; empty  
 倾听 qīng'tīng  
 listen attentively to  
 倾向 qīng'xiàng  
 tendency; trend  
 倾销 qīng'xiāo  
 dump

**轻 qīng**

① light ② small in number, degree, etc. ③ not important  
 ④ gently; softly ⑤ rashly  
 ⑥ belittle; make light of  
 轻放 qīng'fàng  
 put down gently  
 轻工业 qīng'gōng'yè  
 light industry  
 轻声 qīng'shēng  
 in a soft voice; softly

**穷 qióng**

① poor; poverty-stricken  
 ② limit; end ③ thoroughly  
 穷光蛋 qióng'guāng'dàn  
 pauper; poor wretch  
 穷苦 qióng'kǔ  
 impoverished  
 穷人 qióng'rén  
 poor people; the poor

**庆 qìng**

① celebrate; congratulate  
 ② occasion for celebration  
 庆典 qìng'diǎn  
 celebration  
 庆贺 qìng'hè  
 congratulate; celebrate  
 庆祝 qìng'zhù  
 celebrate

**顷 qǐng**

① qǐng, a unit of area (=6.6667 hectares)  
 ② just  
 顷刻 qǐng'kè  
 in a moment; instantly

**请 qǐng**

① request; ask ② invite; engage  
 ③ please  
 请假 qǐng'jià  
 ask for leave  
 请柬 qǐng'jiǎn  
 invitation card  
 请示 qǐng'shǐ  
 ask for instructions

**情 qíng**

① feeling; affection ② love; passion ③ favour; kindness  
 ④ situation; circumstances  
 情报 qíng'bào  
 intelligence  
 情歌 qíng'gē  
 love song  
 情书 qíng'shū  
 love letter

**区 qū**

① area; district; region  
 ② an administrative division  
 ③ classify; subdivide  
 区别 qū'bié  
 distinguish; difference  
 区分 qū'fēn  
 differentiate; distinguish  
 区域 qū'yù  
 region; area; district

**球 qiú**

① sphere; globe ② ball ③ the globe; the earth  
 球场 qiú'chǎng  
 field  
 球迷 qiú'mí  
 (ball game)fan  
 球星 qiú'xīng  
 ball game star

**求 qiú**

① beg; request; entreat; beseech  
 ② seek; try ③ demand  
 求婚 qiú'hūn  
 propose  
 求乞 qiú'qǐ  
 beg  
 求学 qiú'xué  
 go to school

**丘 qiū**

① mound; hillock ② grave  
 丘陵 qiū'líng  
 hills  
 丘疹 qiū'zhěn  
 papule

**秋 qiū**

① autumn; fall ② harvest time  
 ③ year ④ a period of time  
 秋季 qiū'jì  
 autumn; fall  
 秋景 qiū'jǐng  
 autumnal landscape  
 秋千 qiū'qiān  
 swing; 打~ have a swing

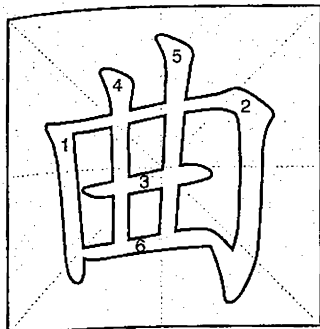

曲 qū 1261

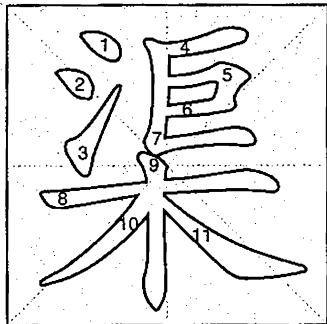

渠 qú 1262

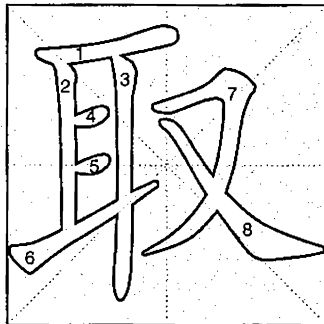

取 qǔ 1263

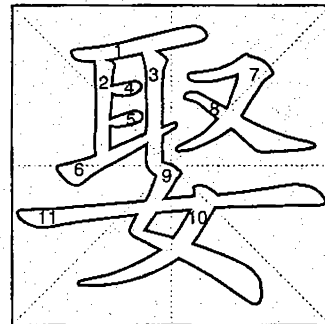

娶 qǔ 1264

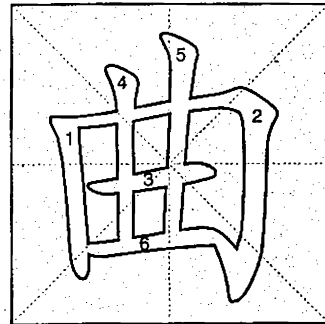

曲 qǔ 1265

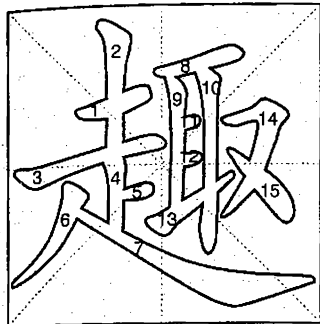

趣 qù 1266

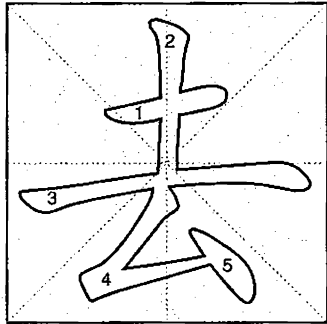

去 qù 1267

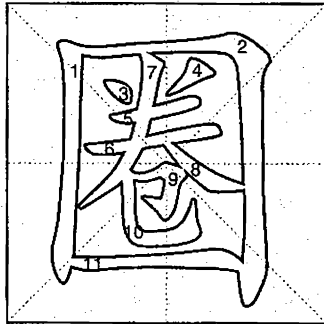

圈 quān 1268

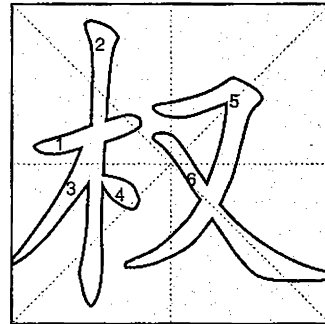

叔 quān 1269

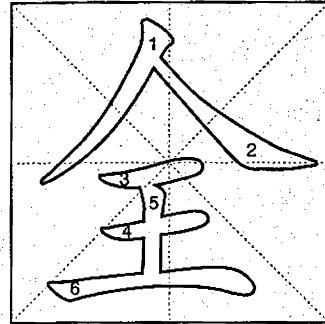

全 quán 1270

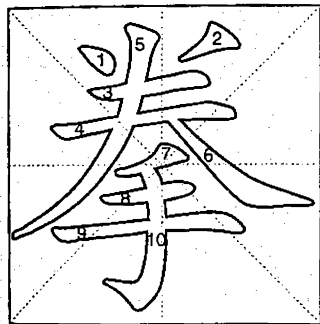

拳 quán 1271

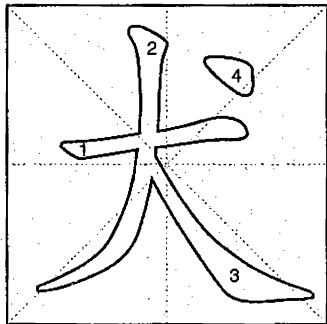

犬 quǎn 1272

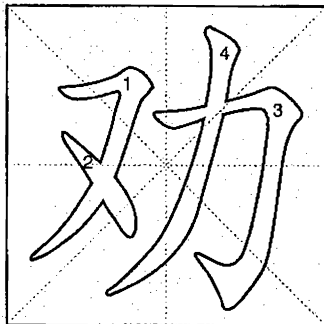

劝 quàn 1273

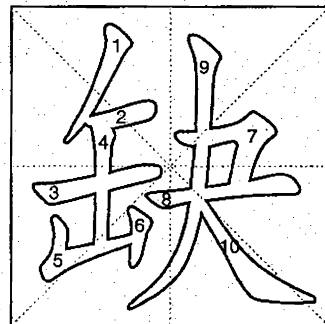

缺 quē 1274

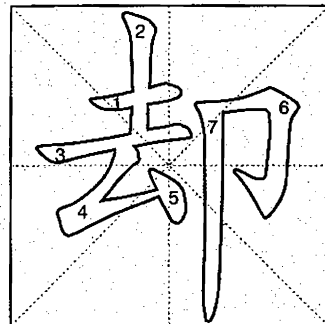

却 què 1275

### 曲 qǔ

① song; tune; melody ② music (of a song)

曲调〈乐〉 qǔ'diào〈yuè〉

tune(of a song); melody

曲艺 qǔ'yì

folk art forms including ballad singing, story telling, comic dialogues, etc.

曲子 qǔ'zi

song; tune; melody

### 娶 qǔ

marry (a woman); take a wife

娶妻 qǔ'qī

take a wife

娶亲 qǔ'qīn

(of a man) get married

### 取 qǔ

① take; get; fetch ② aim at; seek

③ adopt; assume

取代 qǔ'dài

replace; substitute for

取决 qǔ'jué

be decided by

取消 qǔ'xiāo

cancel; call off; abolish

### 渠 qú

canal; channel

渠道 qú'dào

irrigation ditch;

medium of communication

### 曲 qū

① bent; crooked

② bend (of a river, etc.)

③ wrong; unjustifiable

弯曲 wān'qū

zigzag; winding

### 全 quán

① complete ② whole; entire; full; total ③ entirely; completely

④ make perfect or complete; keep intact

全称 quán'chēng

full name

全民公决 quán'mín'gōng'jué

national referendum

全文 quán'wén

full text

### 权 quán

① right ② power; authority

③ advantageous position

④ tentatively; for the time being

⑤ expediency

权力 quán'lì

power; authority

权术 quán'shù

political trickery

权威 quán'wēi

authority

### 圈 quān

① circle; ring ② group ③ enclose;

encircle ④ mark with a circle

圈点 quān'diǎn

punctuate

圈套 quān'tào

snare; trap

圈椅 quān'yǐ

round-backed armchair

### 去 qù

① go; leave ② remove ③ just

gone

去年 qù'nián

last year

去皮 qù'pí

remove the peel

去污粉 qù'wū'fěn

cleanser

### 趣 qù

① interest; delight ② interesting

③ bent; purport

趣事 qù'shì

interesting stories

趣味 qù'wèi

interest; delight; taste

趣闻 qù'wén

interesting news

### 却 què

① step back ② drive back; repulse ③ decline; refuse ④ but;

yet; while

却步 què'bù

step back; hang back

### 缺 quē

① be short of; lack ② incomplete; imperfect ③ be absent ④ vacancy;

opening

缺点 quē'diǎn

shortcoming; weakness

缺乏 quē'fá

be short of; lack

缺货 quē'huò

be in short supply

### 劝 quàn

① advise; urge; try to persuade

② encourage

劝告 quàn'gào

advise; urge; exhort

劝说 quàn'shuō

persuade; advise

劝阻 quàn'zǔ

dissuade sb. from

### 犬 quǎn

dog

犬齿 quǎn'chǐ

canine tooth

犬牙 quǎn'yá

canine tooth; fang

犬牙交错 quǎn'yá'jiāo'cuò

jigsaw-like

### 拳 quán

① fist ② boxing

拳击 quán'jī

boxing; pugilism

拳头 quán'tóu

fist

拳头产品 quán'tóu'chǎn'pǐn

key product

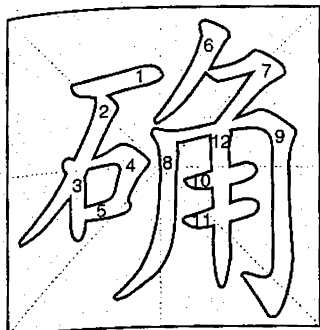

确 què 1276

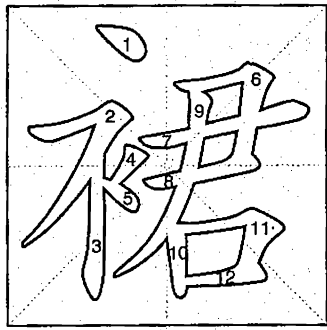

裙 qún 1277



群 qún 1278

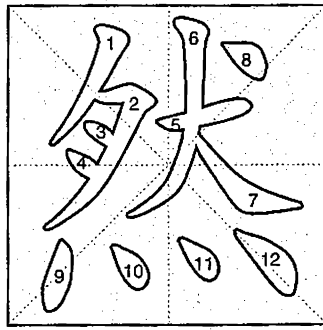

然 rán 1279

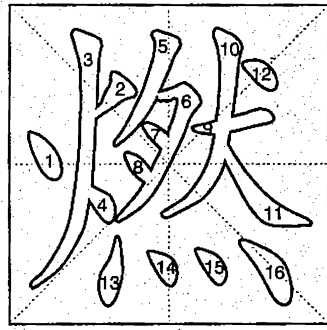

燃 rán 1280

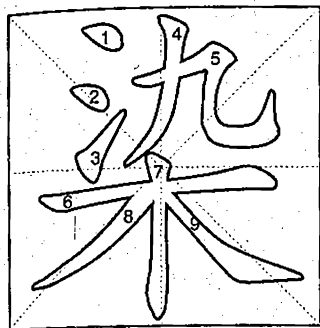

染 rǎn 1281

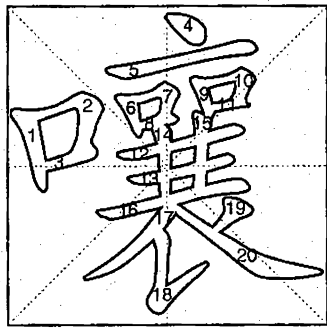

嚷 rāng 1282

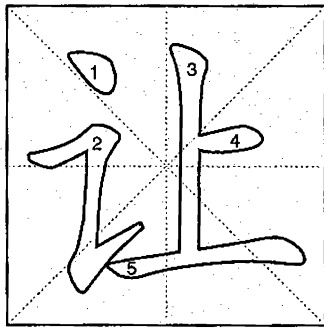

让 ràng 1283

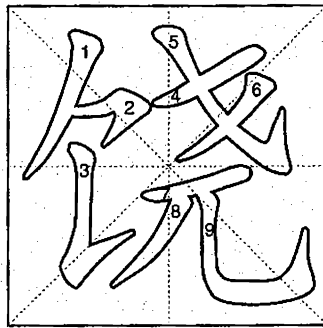

饶 ráo 1284

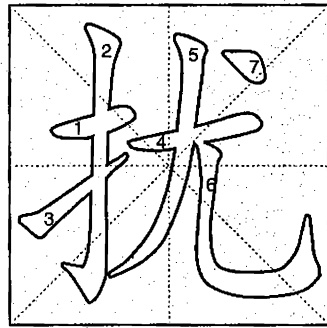

扰 rǎo 1285

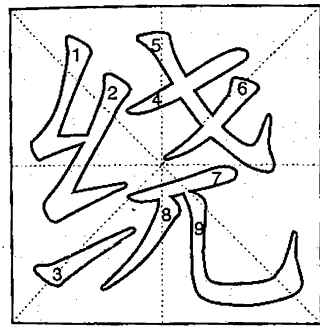

绕 rào 1286

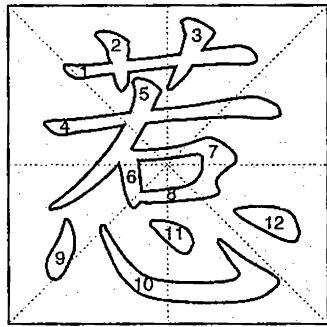

惹 rě 1287



热 rè 1288

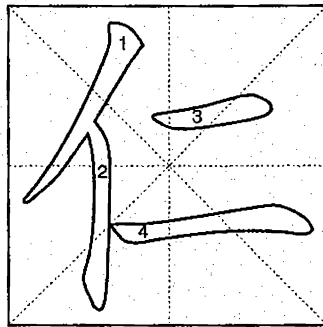

仁 rén 1289

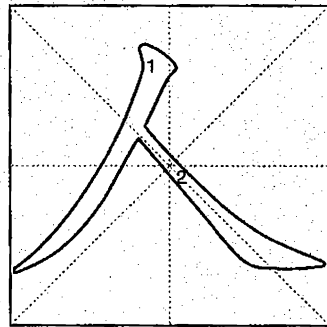

人 rén 1290



### 燃 rán

burn; ignite; light  
 燃料 rán'liào  
 fuel  
 燃气 rán'qì  
 fuel gas  
 燃烧 rán'shāo  
 burn; inflammation

### 然 rán

①right; correct ②so; like that  
 然而 rán'ér  
 yet; but; however  
 然后 rán'hòu  
 then; thereafter

### 群 qún

①crowd; group ②group; herd;  
 flock  
 群芳 qún'fāng  
 all kinds of flowers  
 群居 qún'jū  
 living in groups  
 群众 qún'zhòng  
 the masses

### 裙 qún

skirt  
 裙带 qún'dài  
 nepotism  
 裙裤 qún'kù  
 divided skirt  
 裙子 qún'zi  
 skirt

### 确 què

①true; reliable; authentic  
 ②firmly  
 确保 què'bǎo  
 ensure; guarantee  
 确立 què'lì  
 establish  
 确诊 què'zhěn  
 make a definite diagnosis

### 扰 rǎo

harass; trouble  
 扰动 rǎo'dòng  
 perturbation motion  
 扰乱 rǎo'luàn  
 disturb; make a mess of  
 扰民 rǎo'mín  
 disturb residents

### 饶 ráo

①rich; plentiful ②have mercy on;  
 let sb. off ③give sth. extra  
 饶命 ráo'mìng  
 spare sb.'s life  
 饶舌 ráo'shé  
 too talkative; garrulous  
 饶恕 ráo'shù  
 forgive; pardon

### 让 ràng

①give way; give ground; yield;  
 give up ②invite; offer ③let; allow;  
 make ④let sb. have sth. at a fair  
 price  
 让步 ràng'bù  
 make concessions; give in  
 让路 ràng'lù  
 give way  
 让座 ràng'zuò  
 offer one's seat to sb.

### 嚷 rāng

嚷嚷 rāng'rāng  
 shout; make an uproar

### 染 rǎn

①dye ②catch (a disease);  
 acquire (a bad habit, etc.); soil;  
 contaminate  
 染病 rǎn'bìng  
 fall sick  
 染发 rǎn'fà  
 dye hair  
 染指甲 rǎn'zhǐ'jiǎ  
 paint fingernails

### 人 rén

①human being; man; person;  
 people ②adult ③a person engaged  
 in a particular activity ④(other)  
 people  
 人工 rén'gōng  
 man-made; artificial  
 人口 rén'kǒu  
 population  
 人权 rén'quán  
 human rights

### 仁 rén

①benevolence; humanity  
 ②sensitive ③kernel  
 仁爱 rén'ài  
 charity  
 仁慈 rén'cí  
 kindness; merciful  
 仁兄 rén'xiōng  
 my dear friend

### 热 rè

①heat ②hot ③heat up; warm  
 ④fever; temperature ⑤ardent;  
 warmhearted ⑥craze; fad  
 热爱 rè'ài  
 love; have deep love for  
 热力 rè'lì  
 heating power  
 热身 rè'shēn  
 warm-up

### 惹 rě

①invite or ask for ②offend;  
 tease ③attract; cause  
 惹祸 rě'huò  
 bring misfortune  
 惹麻烦 rě'má'fan  
 make trouble  
 惹气 rě'qì  
 get angry

### 绕 rào

①wind; coil ②circle; revolve  
 ③make a detour; go round  
 绕道 rào'dào  
 make a detour  
 绕口令 rào'kǒu'lìng  
 tongue twister  
 绕行 rào'xíng  
 go in a roundabout way

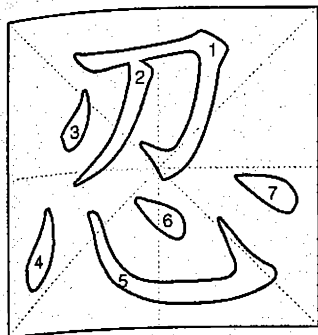

忍 rěn 1291

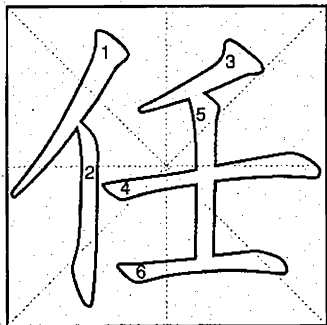

任 rèn 1292

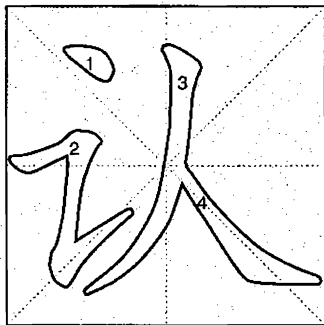

认 rèn 1293

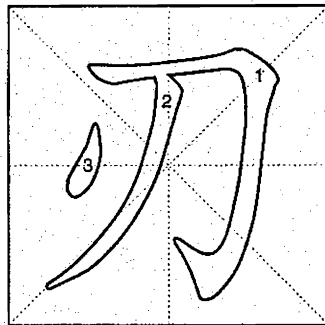

刃 rèn 1294

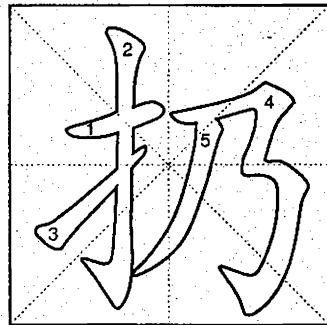

扔 rēng 1295

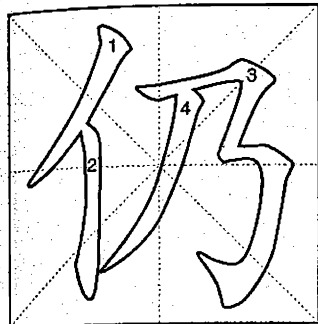

仍 réng 1296

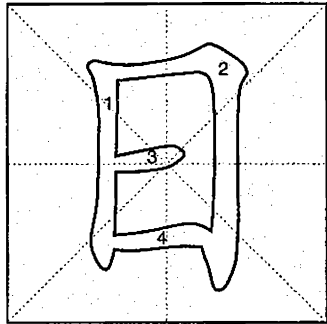

日 rì 1297

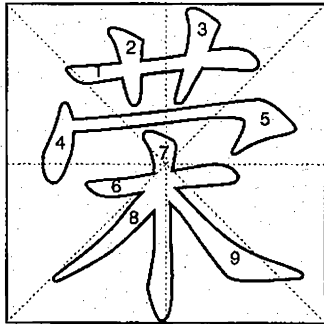

荣 róng 1298

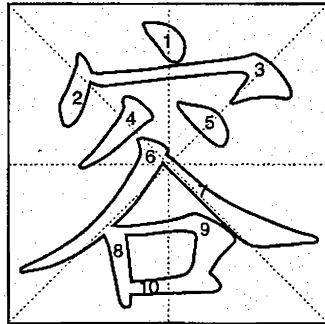

容 róng 1299

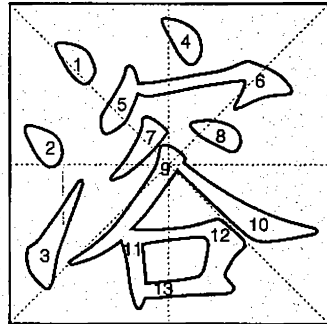

溶 róng 1300

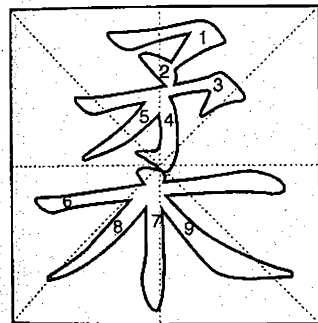

柔 róu 1301

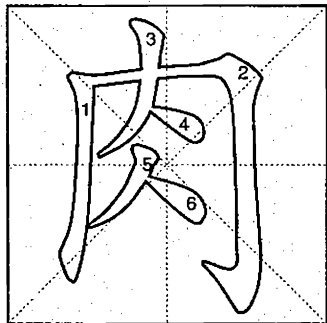

肉 ròu 1302

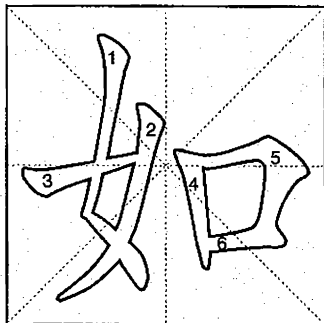

如 rú 1303

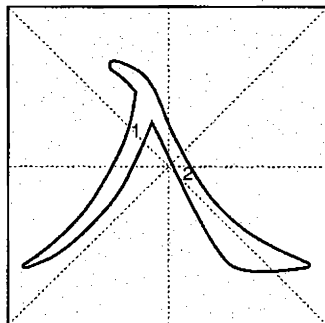

入 rù 1304

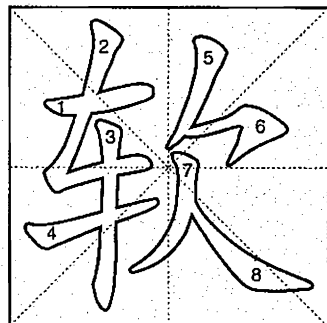

软 ruǎn 1305

### 扔 rēng

① throw; toss; cast ② throw away; cast aside  
 扔掉 rēng'diào  
 throw away  
 扔下 rēng'xià  
 abandon; put aside

### 刃 rèn

① the edge of a knife; sword, etc.; blade ② sword; knife ③ kill with a sword or knife  
 刀具 rèn'jù  
 cutting tool

### 认 rèn

① recognize; know; make out ② adopt ③ admit; recognize; own  
 认购 rèn'gòu  
 subscribe; offer to buy  
 认同 rèn'tóng  
 identity  
 认养 rèn'yǎng  
 adopt and bring up

### 任 rèn

① appoint ② assume a post; take up a job ③ official post; office ④ let; allow ⑤ no matter (how, what, etc.)  
 任何 rèn'hé  
 any; whatever  
 任命 rèn'mìng  
 appoint  
 任务 rèn'wù  
 task; mission

### 忍 rěn

① bear; tolerate; put up with ② be hardhearted enough to  
 忍让 rěn'ràng  
 exercise forbearance  
 忍受 rěn'shòu  
 endure; stand  
 忍痛 rěn'tòng  
 reluctantly

### 溶 róng

dissolve  
 溶化 róng'huà  
 dissolve; melt; thaw  
 溶解 róng'jiě  
 dissolve  
 溶液 róng'yè  
 solution

### 容 róng

① hold; contain ② tolerate ③ permit; allow ④ facial expression ⑤ appearance; looks  
 容量 róng'liàng  
 capacity  
 容器 róng'qì  
 container  
 容易 róng'yì  
 easy; apt; likely

### 荣 róng

① grow luxuriantly; flourish ② honour; glory  
 荣获 róng'huò  
 have the honour to get  
 荣任 róng'rèn  
 be honored with a post  
 荣幸 róng'xìng  
 be honoured

### 日 rì

① sun ② daytime ③ day ④ daily; with each passing day ⑤ time  
 日班 rì'bān  
 day shift  
 日记 rì'jì  
 diary  
 日期 rì'qī  
 date

### 仍 réng

① remain ② still; yet  
 仍旧 réng'jiù  
 as usual; still; yet  
 仍然 réng'rán  
 still; yet

### 软 ruǎn

① soft; flexible; supple; pliable ② mild; gentle ③ weak; feeble ④ poor in quality, ability, etc.  
 软包装 ruǎn'bāo'zhuāng  
 soft packing  
 软水 ruǎn'shuǐ  
 soft water  
 软饮料 ruǎn'yǐn'liào  
 soft drink

### 入 rù

① enter ② join; be admitted to ③ income ④ conform to; agree with  
 入境签证 rù'jìng'qiān'zhèng  
 entry visa  
 入口 rù'kǒu  
 entrance  
 入睡 rù'shуй  
 fall asleep

### 如 rú

① in compliance with; according to ② like; as; as if ③ be as good as ④ for instance; such as; as ⑤ if  
 如果 rú'guǒ  
 if; in case; supposing that  
 如何 rú'hé  
 how; why; what  
 如今 rú'jīn  
 nowadays; now

### 肉 ròu

① meat; flesh ② pulp; flesh (of fruit)  
 肉饼 ròu'bǐng  
 meat pie  
 肉片 ròu'piàn  
 sliced meat  
 肉丸 ròu'wán  
 meatball

### 柔 róu

① soft; supple; flexible ② gentle; yielding; mild  
 柔和 róu'hé  
 soft; gentle  
 柔软 róu'ruǎn  
 soft; flexible  
 柔弱 róu'ruò  
 weak; soft; meek

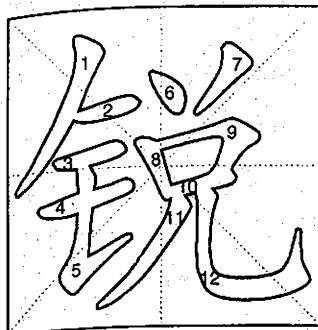

锐 ruì 1306

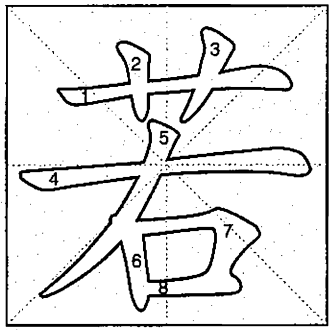

若 ruò 1307

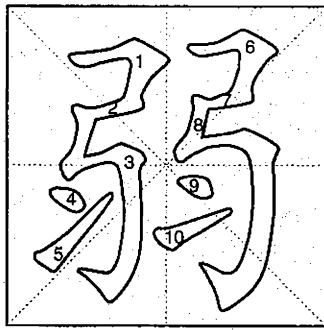

弱 ruò 1308

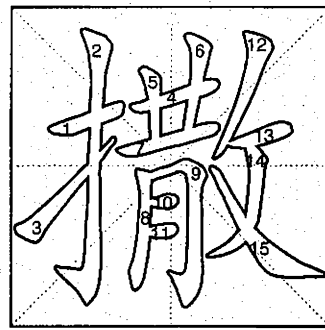

撒 sā 1309

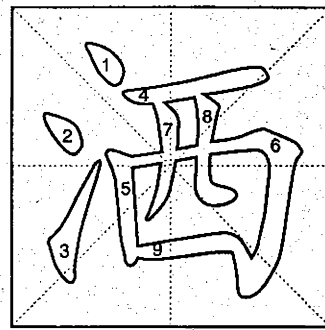

洒 sǎ 1310

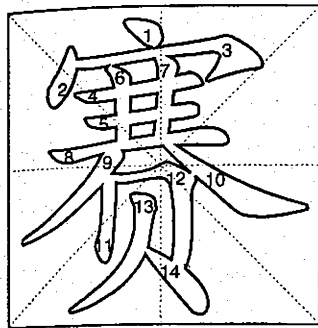

赛 sài 1311

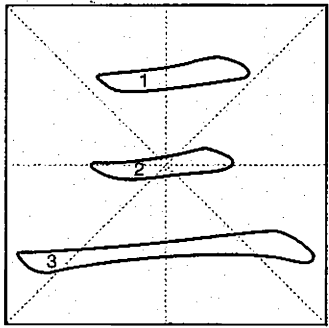

三 sān 1312

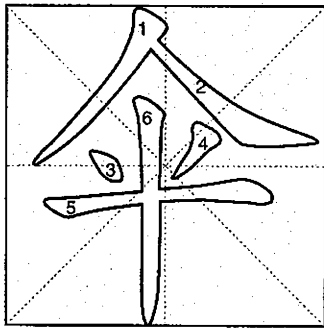

伞 sǎn 1313

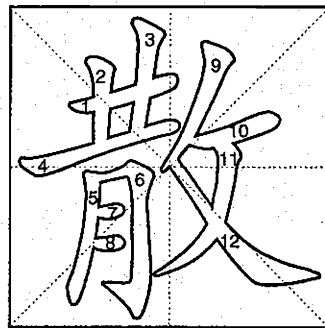

散 sǎn 1314

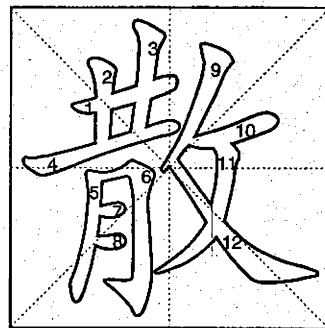

散 sàn 1315

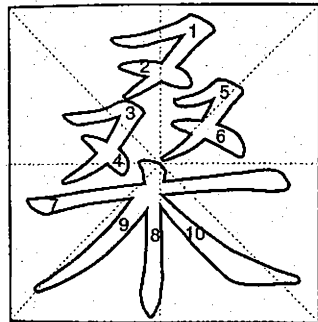

桑 sāng 1316

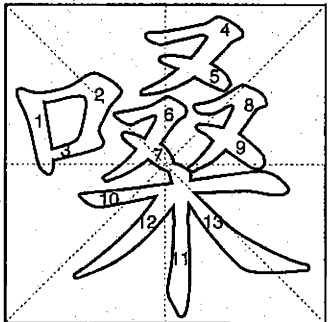

嗓 sǎng 1317

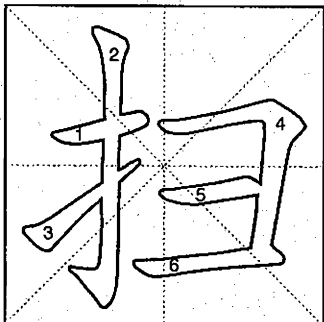

扫 sǎo 1318

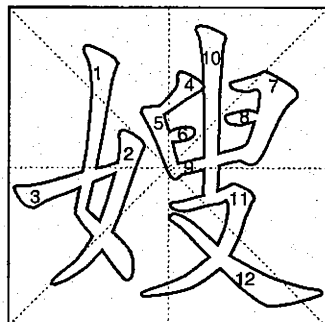

嫂 sǎo 1319

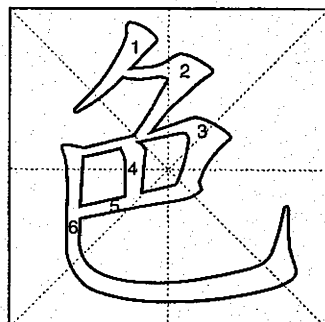

色 sè 1320

### 洒 sǎ

sprinkle; spray; spill  
 洒泪 sǎ'lèi  
 shed tears  
 洒水 sǎ'shuǐ  
 sprinkle water  
 洒水车 sǎ'shuǐ'chē  
 watering car; sprinkler

### 撒 sā

① cast; let go; let out  
 ② throw off all restraint; let oneself go  
 撒谎 sā'huǎng  
 tell a lie  
 撒娇 sā'jiāo  
 act like a spoiled child  
 撒野 sā'yě  
 act wildly

### 弱 ruò

weak; feeble  
 弱点 ruò'diǎn  
 weak points; failing  
 弱项(体) ruò'xiàng(tǐ)  
 weak sports  
 弱智 ruò'zhì  
 mental retardation

### 若 ruò

① like; seem; as if ② if  
 若不然 ruò'bù'rán  
 if not; otherwise  
 若非 ruò'fēi  
 if not; were it not for  
 若干 ruò'gān  
 a certain number or amount

### 锐 ruì

① sharp; keen; acute  
 ② vigour; fighting spirit  
 锐角(数) ruì'jiǎo(shù)  
 acute angle  
 锐利 ruì'lì  
 sharp  
 锐气 ruì'qì  
 fortitude; dauntless courage

### 散 sǎn

① break up; disperse  
 ② distribute; disseminate  
 ③ dispel; let out  
 散播 sǎn'bō  
 spread  
 散步 sǎn'bù  
 take a walk; go for a walk  
 散场 sǎn'chǎng  
 be over

### 散 sǎn

① come loose; fall apart  
 ② medicinal powder  
 散光 sǎn'guāng  
 astigmatism  
 散文 sǎn'wén  
 essay; prose  
 散装 sǎn'zhuāng  
 in bulk

### 伞 sǎn

umbrella  
 伞兵 sǎn'bīng  
 paratrooper; parachuter  
 伞兵部队 sǎn'bīng'bù'duì  
 parachute troops  
 伞架 sǎn'jià  
 umbrella stand

### 三 sān

① three ② several; many  
 三胞胎 sān'bāo'tāi  
 triples  
 三角形(数) sān'jiǎo'xíng(shù)  
 triangle  
 三月 sān'yuè  
 March

### 赛 sài

① match; game; competition; contest ② be comparable to; surpass  
 赛马 sài'mǎ  
 horse race  
 赛跑 sài'pǎo  
 race  
 赛艇 sài'tǐng  
 rowing; shell

### 色 sè

① color ② look; countenance; expression ③ kind; description  
 ④ scene; scenery ⑤ quality  
 色标 sè'biāo  
 color code  
 色带 sè'dài  
 ribbon  
 色拉 sè'lǎ  
 salad

### 嫂 sǎo

① elder brother's wife; sister-in-law  
 ② sister  
 嫂子 sǎo'zi  
 sister-in-law

### 扫 sǎo

① sweep; clear away ② pass quickly along or over ③ put all together  
 扫地 sǎo'dì  
 sweep the floor  
 扫描(电) sǎo'miáo(diàn)  
 scanning  
 扫雪车 sǎo'xuě'chē  
 snow removal truck

### 嗓 sǎng

① throat; larynx ② voice  
 嗓音 sǎng'yīn  
 voice  
 嗓子 sǎng'zi  
 throat; larynx; voice

### 桑 sāng

mulberry  
 桑蚕 sāng'cán  
 silkworm  
 桑拿浴 sāng'ná'yù  
 sauna; sauna bath  
 桑树 sāng'shù  
 white mulberry; mulberry

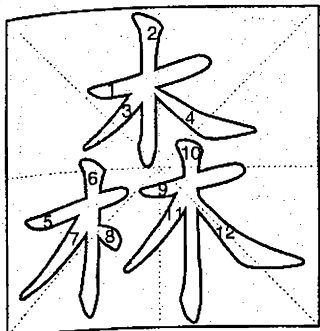

森 sēn 1321

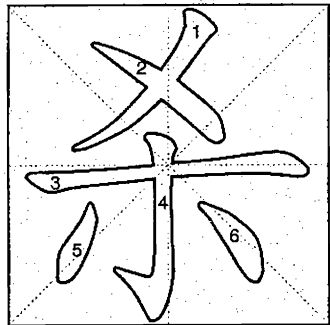

杀 shā 1322

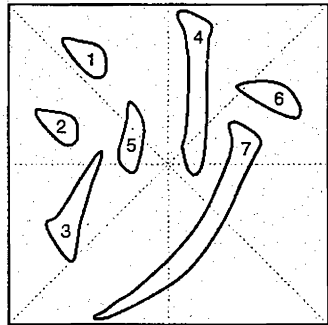

沙 shā 1323

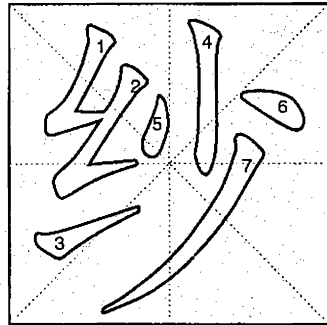

纱 shā 1324

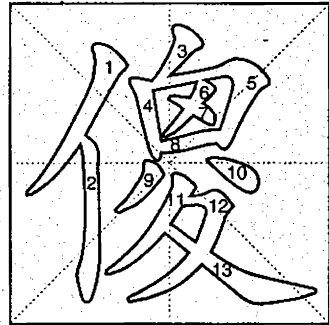

傻 shǎ 1325

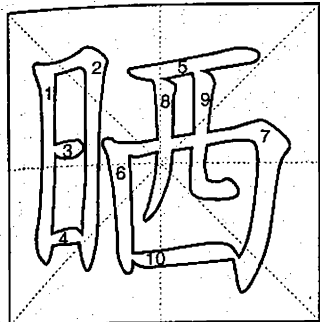

晒 shài 1326

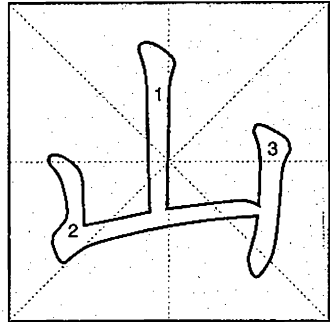

山 shān 1327

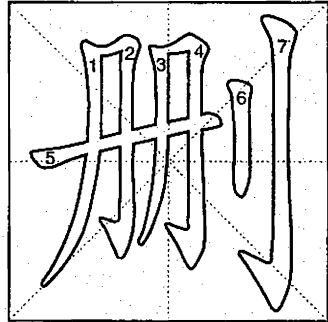

删 shān 1328

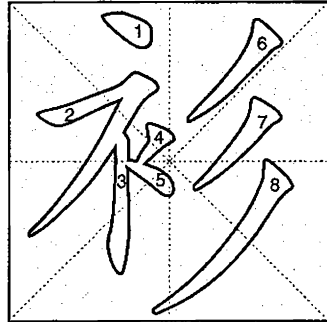

衫 shān 1329

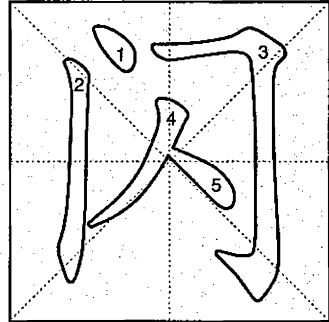

闪 shǎn 1330

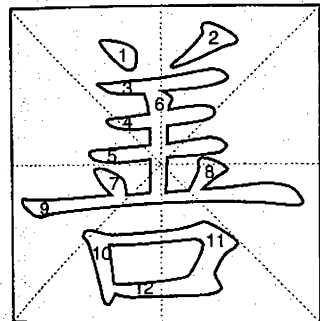

善 shàn 1331

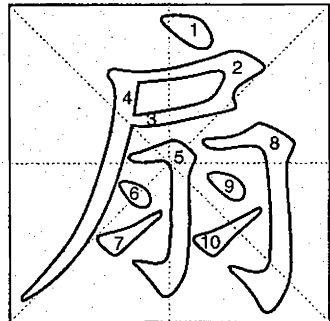

扇 shàn 1332

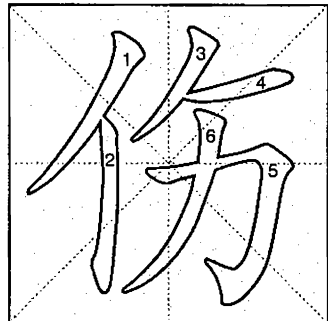

伤 shāng 1333

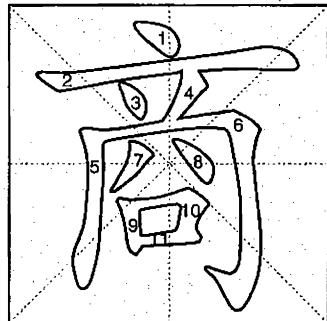

商 shāng 1334

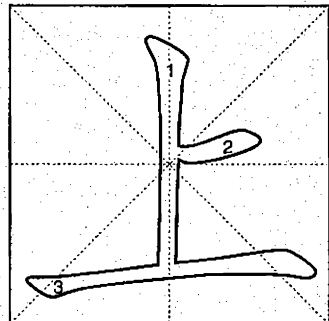

上 shàng 1335

### 傻 shǎ

- ① stupid; muddleheaded  
 ② think or act mechanically  
 傻瓜 shǎ'guā  
 fool; dolt; juggins; zombi  
 傻话 shǎ'huà  
 silly talk  
 傻眼 shǎ'yǎn  
 be dumbfounded

### 纱 shā

- ① yarn ② gauze; sheer  
 纱布 shā'bù  
 gauze  
 纱厂 shā'chǎng  
 cotton mill  
 纱巾 shā'jīn  
 gauze kerchief

### 沙 shā

- ① sand ② granulated; powdered  
 ③ (of voice) hoarse; husky  
 沙丁鱼 shā'dīng'yú  
 sardine  
 沙发 shā'fā  
 sofa; settee  
 沙龙 shā'lóng  
 salon

### 杀 shā

- ① kill; slaughter ② fight; go into  
 battle ③ weaken; reduce  
 杀虫剂 shā'chóng'jì  
 insecticide; pesticide  
 杀菌 shā'jūn  
 disinfect  
 杀手 shā'shǒu  
 killer

### 森 sēn

- ① full of trees ② dark; gloomy  
 森林 sēn'lín  
 forest  
 森严 sēn'yán  
 stern; strict; forbidding  
 森严壁垒 sēn'yán'bì'lěi  
 closely guarded

### 闪 shǎn

- ① dodge; get out of the way  
 ② twist; sprain ③ lightning ④ flash;  
 sparkle; shine  
 闪电 shǎn'diàn  
 lightning; blitz  
 闪开 shǎn'kāi  
 get out of the way  
 闪身 shǎn'shēn  
 dodge

### 衫 shān

- unlined upper garment  
 衬衫 chèn'shān  
 blouse; shirt

### 删 shān

- delete; leave out  
 删除 shān'chú  
 delete; expurgate; cancel  
 删改 shān'gǎi  
 delete and change; revise  
 删节本 shān'jié'běn  
 abridged edition

### 山 shān

- hill; mountain  
 山村 shān'cūn  
 mountain village  
 山洞 shān'dòng  
 cave; cavern  
 山羊 shān'yáng  
 goat; buck

### 晒 shài

- ① (of the sun) shine upon  
 ② dry in the sun; bask  
 晒台 shài'tái  
 flat roof  
 晒太阳 shài'tài'yáng  
 to sun oneself; sunbathe  
 晒图员 shài'tú'yuán  
 blueprinter

### 上 shàng

- ① upper; up; upward ② higher;  
 superior; better ③ first (part);  
 preceding; previous ④ the emperor  
 ⑤ go up; get on ⑥ go to; leave for  
 上班 shàng'bān  
 go to work; start work  
 上交 shàng'jiāo  
 hand in  
 上坡 shàng'pō  
 uphill

### 商 shāng

- ① discuss; consult ② commerce;  
 business ③ merchant; trader; dealer  
 商标 shāng'biāo  
 mark; trademark  
 商品 shāng'pǐn  
 commodity; goods  
 商业中心 shāng'yè'zhōngxīn  
 shopping center

### 伤 shāng

- ① wound; injury ② injure; hurt  
 ③ be distressed ④ get sick; develop  
 an aversion to sth.  
 伤疤 shāng'bā  
 scar  
 伤兵 shāng'bīng  
 wounded soldier  
 伤心 shāng'xīn  
 grieve; grief

### 扇 shàn

- fan  
 扇贝(动) shàn'bèi(dòng)  
 scallop  
 扇面 shàn'miàn  
 the covering of a fan  
 扇子 shàn'zi  
 fan

### 善 shàn

- ① good ② satisfactory ③ make a  
 success of; perfect ④ kind; friendly  
 ⑤ be good at; be expert in  
 善本 shàn'běn  
 reliable text; good edition  
 善后 shàn'hòu  
 funeral arrangements  
 善意 shàn'yì  
 good will; good intentions

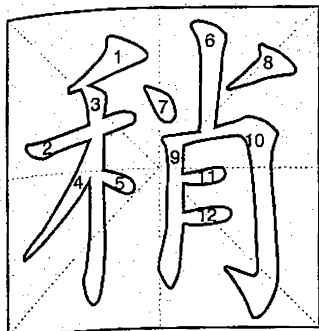

稍 shāo 1336

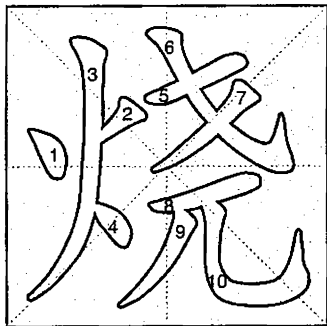

烧 shāo 1337

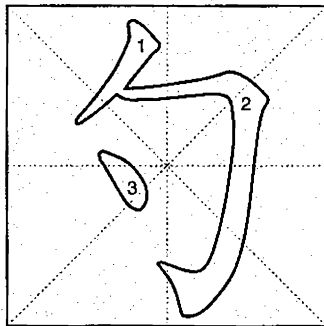

勺 sháo 1338

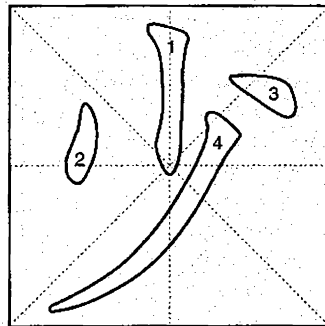

少 shǎo 1339

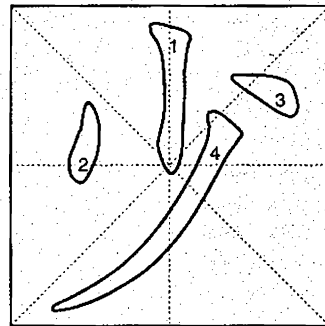

少 shào 1340

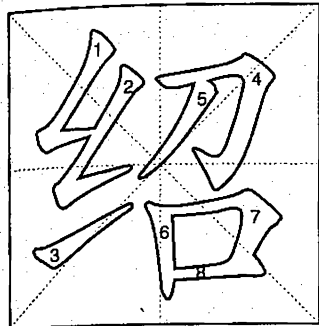

绍 shào 1341

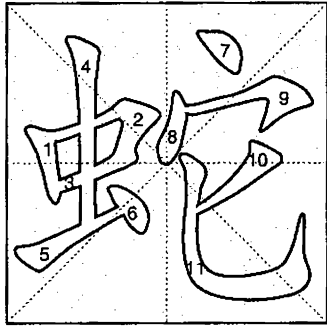

蛇 shé 1342

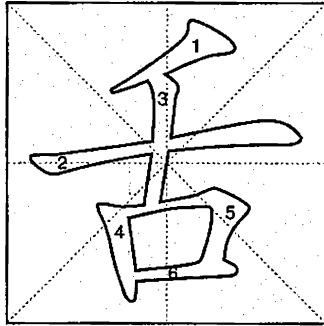

舌 shé 1343

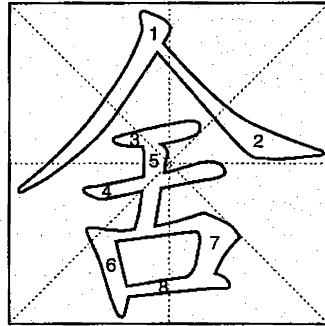

舍 shě 1344

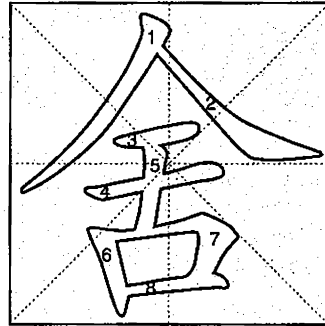

舍 shè 1345

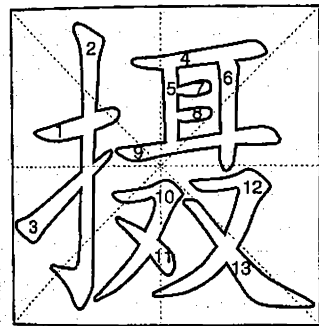

摄 shè 1346

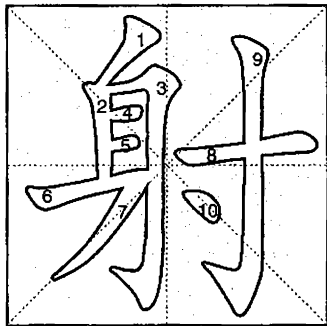

射 shè 1347

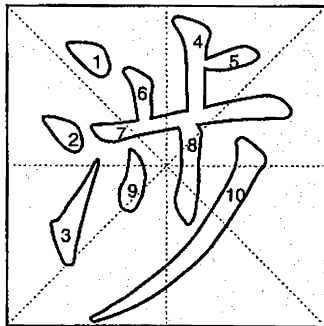

涉 shè 1348

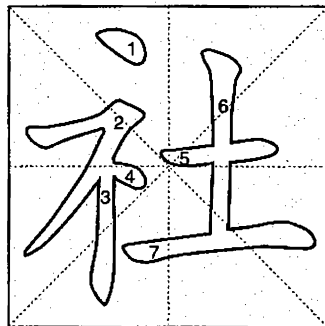

社 shè 1349

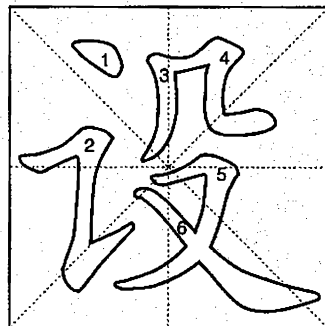

设 shè 1350



### 少 shǎo

①young ②son of a rich family;  
young master  
少妇 shǎo'fù  
young married woman  
少将 shǎo'jiāng  
major general  
少年 shǎo'nián  
early youth

### 少 shǎo

①few; little; less ②be short; lack  
③lose; be missing ④a little while  
⑤stop; quit  
少见 shǎo'jiàn  
rare; exceptional  
少量 shǎo'liàng  
paucity; a small amount  
少数民族 shǎo'shù'mín'zú  
minority nationality

### 勺 sháo

spoon; ladle; dipper scoop  
勺子 sháo'zi  
ladle; scoop

### 烧 shāo

①burn ②cook; bake; heat  
③stew; fry; roast ④run a fever  
烧饭 shāo'fàn  
cook  
烧鸡 shāo'jī  
roast chicken  
烧酒 shāo'jiǔ  
white spirit

### 稍 shāo

a little; a bit  
稍稍 shāo'shāo  
just a little  
稍微 shāo'wēi  
a little

### 舍 shè

①house; shed; hut ②my  
舍间 shè'jiān  
my humble abode; my house  
舍利〈佛教〉 shè'lì'fó'jiào  
Buddhist relics  
舍利塔 shè'lì'tǎ  
pagoda for Buddhist relics

### 舍 shě

give up; abandon  
舍命 shě'mìng  
risk one's life  
舍弃 shě'qì  
give up; abandon  
舍身 shě'shēn  
give one's life

### 舌 shé

tongue  
舌尖 shé'jiān  
the tip of the tongue  
舌头 shé'tou  
tongue  
舌战 shé'zhàn  
have a verbal battle with

### 蛇 shé

snake; serpent  
蛇毒 shé'dú  
snake venom; venom  
蛇伤 shé'shāng  
snakebite  
蛇行 shé'xíng  
crawl

### 绍 shào

介绍 jiè'shào  
introduce; present

### 设 shè

set up; establish; found  
设备 shè'bèi  
equipment; installation  
设计 shè'jì  
plan; project; block  
设宴 shè'yàn  
give a banquet; fête

### 社 shè

① organized body; agency;  
society ②people's commune  
社会 shè'huì  
public; society  
社区 shè'qū  
community  
社团 shè'tuán  
mass organizations

### 涉 shè

① wade; ford ② go through;  
experience  
涉案 shè'àn  
involved in a case  
涉及 shè'jī  
involve; relate to  
涉外 shè'wài  
concerning foreign affairs

### 射 shè

①shoot; fire ②discharge in a jet  
③ send out (light, heat, etc.) ④  
allude to sth. or sb.  
射箭 shè'jiàn  
shoot an arrow; archery  
射门〈体〉 shè'mén(tǐ)  
shoot(at the goal)  
射线 shè'xiàn  
ray

### 摄 shè

① absorb; assimilate ② take a  
photograph of; shoot ③ conserve  
(one's health)  
摄食 shè'shí  
ingest  
摄影机 shè'yǐng'jī  
camera  
摄影师 shè'yǐng'shī  
photographer; cameraman

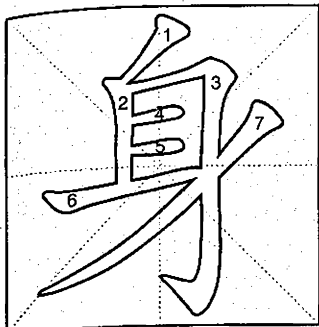

身 shēn 1351

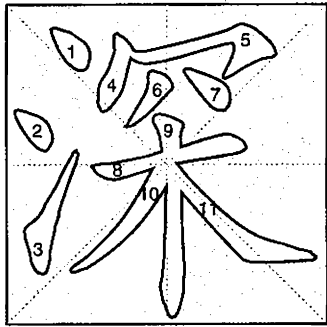

深 shēn 1352

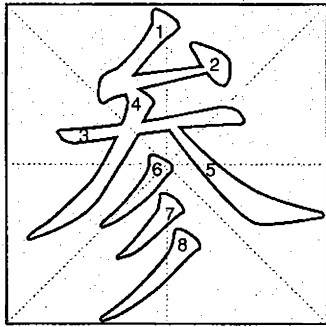

参 shēn 1353

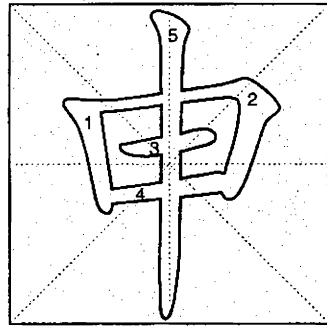

申 shēn 1354

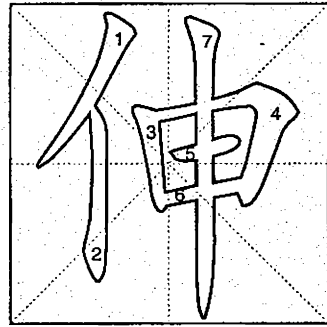

伸 shēn 1355

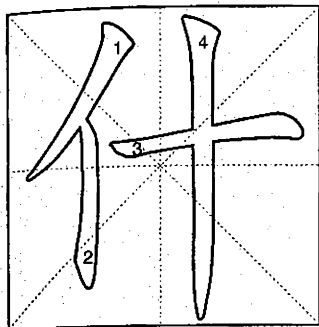

什 shén 1356

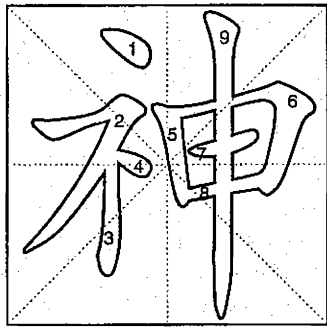

神 shén 1357

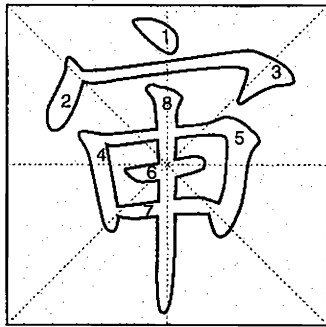

审 shěn 1358

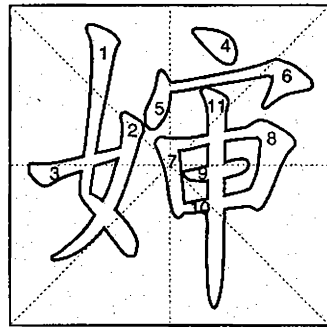

婶 shěn 1359

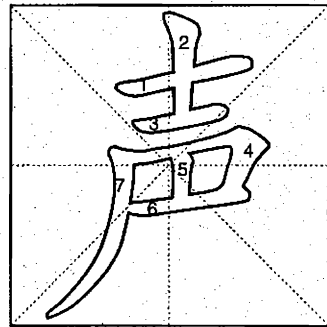

声 shēng 1360

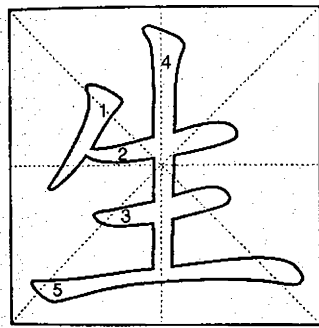

生 shēng 1361

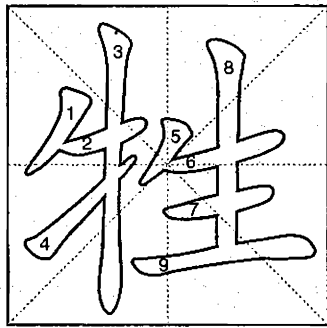

牲 shēng 1362

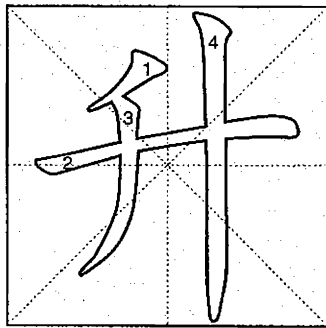

升 shēng 1363

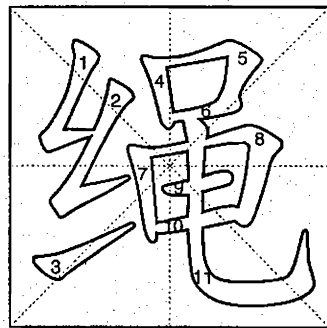

绳 shéng 1364

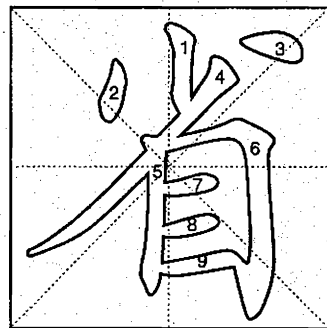

省 shěng 1365

### 伸 shēn

stretch; extend  
 伸长 shēn'cháng  
 elongate  
 伸腰 shēn'yāo  
 straighten one's back  
 伸直 shēn'zhí  
 straighten; extend

### 申 shēn

state; express; explain  
 申请书 shēn'qǐng'shū  
 (written) application  
 申诉 shēn'sù  
 appeal; declaration  
 申冤 shēn'yuān  
 redress an injustice

### 参 shēn

ginseng

### 深 shēn

①deep ②difficult; profound  
 ③thoroughgoing penetrating profound  
 ④close; intimate ⑤dark ⑥late  
 深呼吸 shēn'hū'xī  
 deep breathing  
 深山 shēn'shān  
 remote mountains  
 深信 shēn'xìn  
 deeply believe

### 身 shēn

① body ② life ③ oneself;  
 personally ④ one's moral character  
 and conduct  
 身份 shēn'fēn  
 status; capacity; identity  
 身体 shēn'tǐ  
 body; health  
 身孕 shēn'yùn  
 pregnancy; pregnant

### 声 shēng

①sound; voice ②made a sound  
 声波 shēng'bō  
 sound wave  
 声明 shēng'míng  
 state; declare; announce  
 声音 shēng'yīn  
 sound; voice

### 婶 shěn

wife of father's younger brother;  
 aunt  
 婶母 shěn'mǔ  
 aunt

### 审 shěn

①careful ②examine; go over  
 ③interrogate  
 审定 shěn'dìng  
 examine and approve  
 审计 shěn'jì  
 audit  
 审问 shěn'wèn  
 interrogate; question

### 神 shén

①god; deity; divinity ②superna-  
 tural; magical ③spirit; mind  
 ④expression; look  
 神经 shén'jīng  
 nerve  
 神秘 shén'mì  
 mysterious; mystical  
 神学院 shén'xué'yuàn  
 theological college

### 什 shén

什么 shén'me  
 what; whatever; anything  
 什么的 shén'me'de  
 and so on; and so forth

### 省 shěng

①economize; save ②omit; leave  
 out ③province  
 省份 shěng'fèn  
 province  
 省钱 shěng'qián  
 save money; be economical  
 省心 shěng'xīn  
 save worry

### 绳 shéng

①rope; cord; string ②restrict;  
 restrain  
 绳索 shéng'suǒ  
 rope; cord  
 绳梯 shéng'tī  
 rope ladder  
 绳子 shéng'zi  
 cord; rope; string

### 升 shēng

①rise; hoist; go up; ascend  
 ②promote ③litre  
 升旗 shēng'qí  
 raise a flag  
 升学 shēng'xué  
 enter a higher school  
 升值 shēng'zhí  
 revalue; appreciate

### 牲 shēng

① domestic animal ② animal  
 sacrifice  
 牲畜 shēng'chù  
 livestock  
 牲口 shēng'kǒu  
 draught animals

### 生 shēng

① give birth to (a child); bear  
 ②grow ③life ④livelihood ⑤living  
 ⑥get; have ⑦light (a fire, stove,  
 etc.)  
 生病 shēng'bìng  
 fall ill  
 生辰 shēng'chén  
 birthday  
 生词 shēng'cí  
 new word

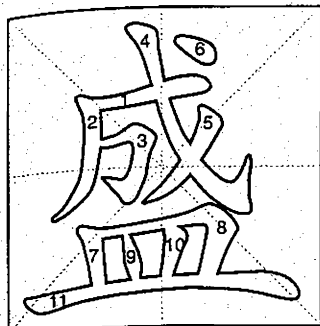

盛 shèng 1366

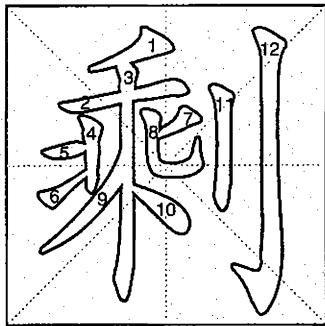

剩 shèng 1367

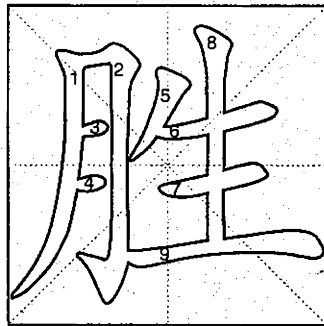

胜 shèng 1368

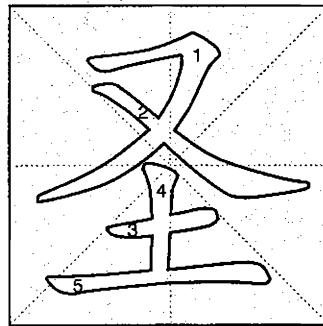

圣 shèng 1369

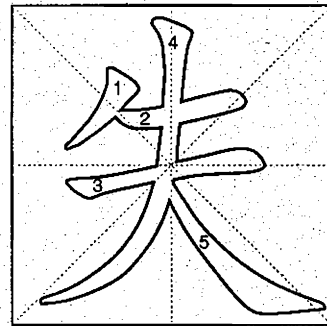

失 shī 1370

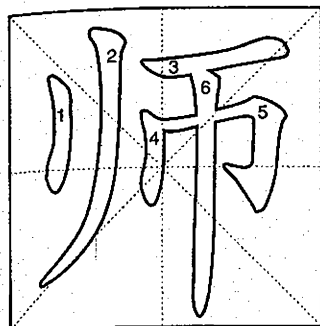

师 shī 1371

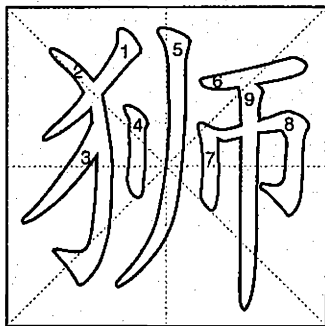

狮 shī 1372

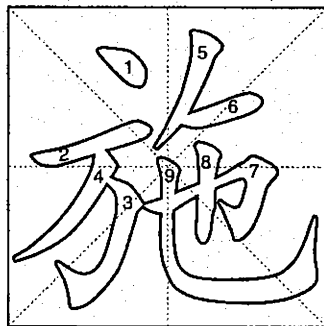

施 shī 1373

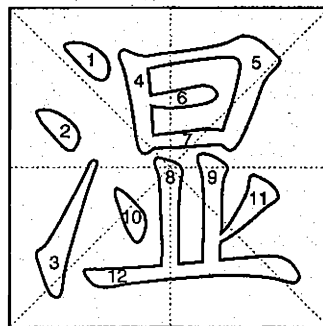

湿 shī 1374

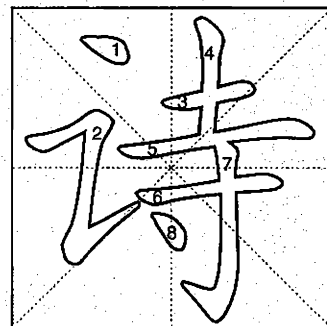

诗 shī 1375

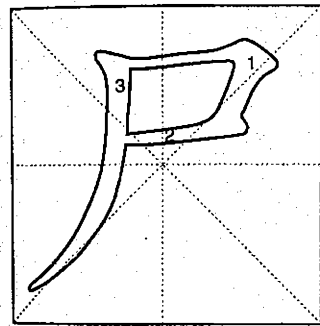

尸 shī 1376

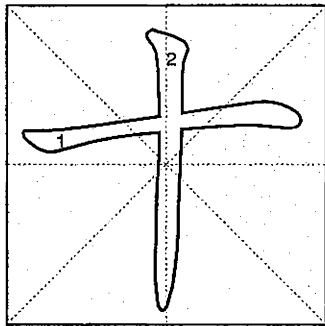

十 shí 1377

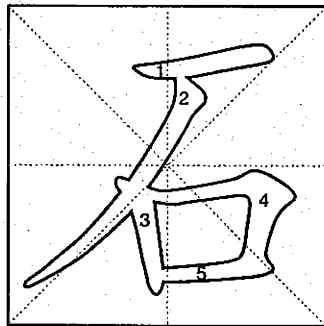

石 shí 1378

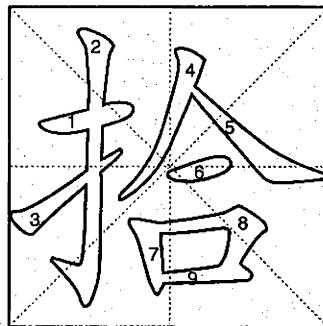

拾 shí 1379

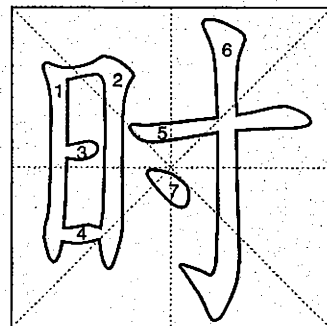

时 shí 1380

### 失 shī

①lose ②miss; let slip ③fail to achieve one's end ④defect; mistake ⑤break (a promise); go back on (one's word)  
 失败 shī' bài  
 be defeated; fail  
 失宠 shī' chǒng  
 unwise; inexpedient  
 失恋 shī' liàn  
 be disappointed in a love affair

### 圣 shèng

①sage; saint ②holy; sacred  
 圣诞节 shèng' dàn' jié  
 Christmas Day  
 圣父 shèng' fù  
 the Father  
 圣经 shèng' jīng  
 the Bible

### 胜 shèng

①victory; success ②surpass; be superior to; get the better of ③superb; wonderful; lovely  
 胜败 shèng' bài  
 victory or defeat  
 胜地 shèng' dì  
 famous scenic spot  
 胜利者 shèng' lì' zhě  
 winner

### 剩 shèng

surplus; remnant  
 剩饭 shèng' fàn  
 rice leftover  
 剩下 shèng' xià  
 be left (over); remain  
 剩余 shèng' yú  
 surplus; remainder

### 盛 shèng

①flourishing; prosperous ②vigorous; energetic ③magnificent; grand ④abundant; plentiful  
 盛典 shèng' diǎn  
 grand ceremony  
 盛开 shèng' kāi  
 be in bloom; flush  
 盛夏 shèng' xià  
 midsummer

### 诗 shī

poetry; verse; poem  
 诗歌 shī' gē  
 poems and songs; poetry  
 诗篇 shī' piān  
 poem  
 诗人 shī' rén  
 poet

### 湿 shī

wet; damp; humid  
 湿地 shī' dì  
 wetland  
 湿度 shī' dù  
 humidity  
 湿润 shī' rùn  
 moist

### 施 shī

①execute; carry out ②bestow; grant ③exert; impose ④use; apply  
 施暴 shī' bào  
 resort to violence; rape  
 施舍 shī' shě  
 give alms; give in charity  
 施政方针 shī' zhèng' fāng' zhēn  
 administrative politics

### 狮 shī

lion  
 狮身人面像  
 shī' shēn' rén' miàn' xiàng  
 sphinx  
 狮子 shī' zi  
 lion  
 狮子舞 shī' zi' wǔ  
 lion dance

### 师 shī

①teacher; master ②model; example ③of one's master or teacher ④division ⑤troops; army  
 师部 shī' bù  
 division headquarters  
 师范学院 shī' fàn' xué' yuàn  
 teachers college  
 师傅 shī' fu  
 master

### 时 shí

①time; times; days ②fixed time ③hour ④season ⑤current; present ⑥opportunity; chance  
 时差 shí' chā  
 time difference  
 时价 shí' jià  
 current price  
 时间 shí' jiān  
 time

### 拾 shí

pick up; collect  
 拾金不昧 shí' jīn' bù' mèi  
 not pocket the money one picks up  
 拾取 shí' qǔ  
 pick-up; collect  
 拾遗 shí' yí  
 appropriate lost property

### 石 shí

①stone; rock ②stone inscription  
 石膏 shí' gāo  
 gypsum; plaster stone  
 石灰 shí' huī  
 lime  
 石油 shí' yóu  
 petroleum; oil

### 十 shí

①ten ②topmost  
 十二月 shí' èr' yuè  
 December  
 十万火急 shí' wàn' huǒ' jí  
 most urgent  
 十字架 shí' zì' jià  
 cross

### 尸 shī

corpse; dead body; remains  
 尸骨 shī' gǔ  
 skeleton  
 尸检 shī' jiǎn  
 necropsy  
 尸首 shī' shǒu  
 corpse; dead body; remains

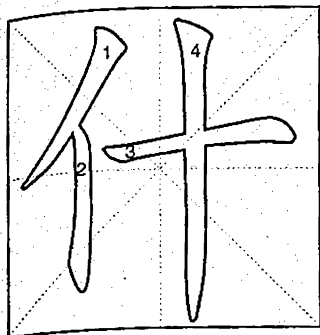

什 shí 1381

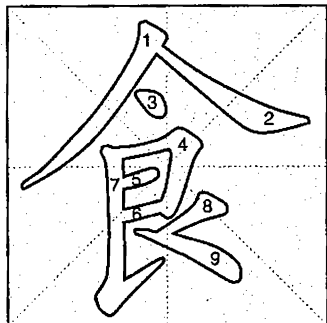

食 shí 1382

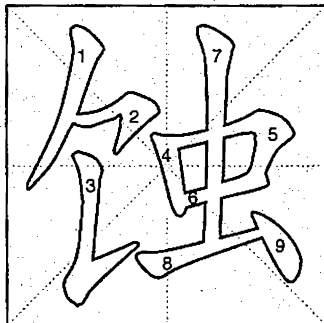

蚀 shí 1383

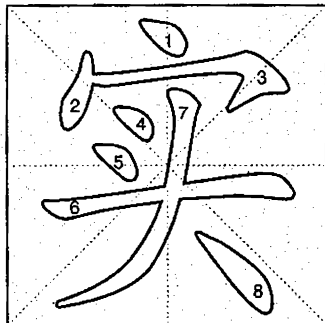

实 shí 1384

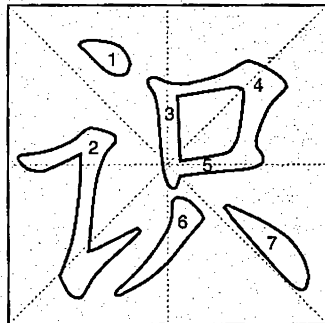

识 shí 1385

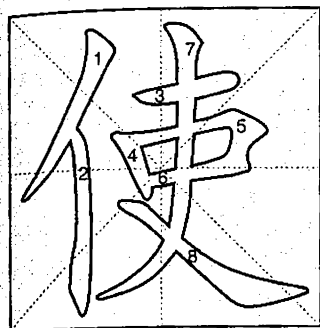

使 shǐ 1386

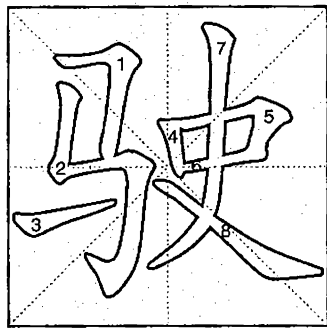

驶 shǐ 1387

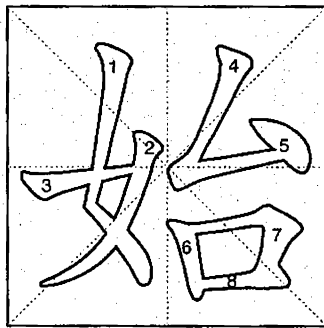

始 shǐ 1388

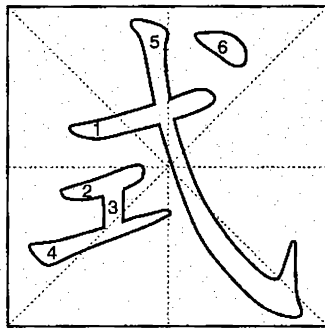

式 shì 1389

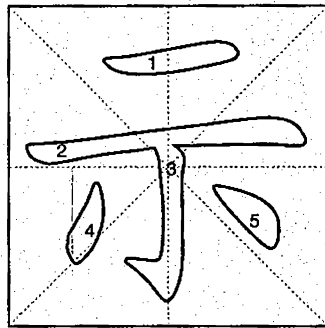

示 shì 1390

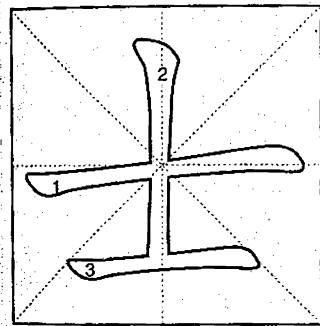

士 shì 1391

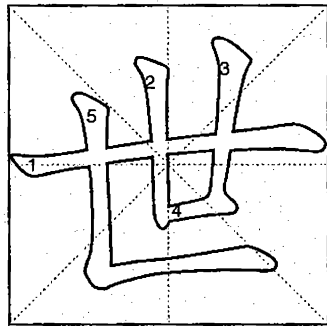

世 shì 1392

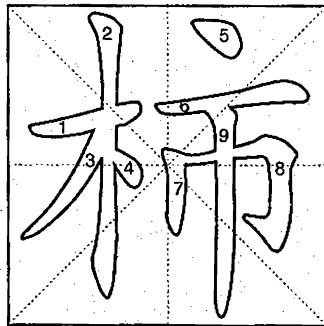

柿 shì 1393

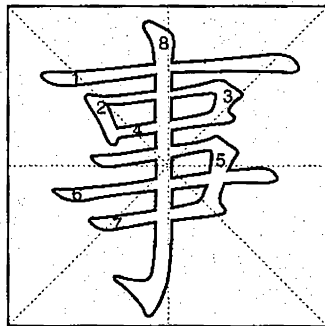

事 shì 1394

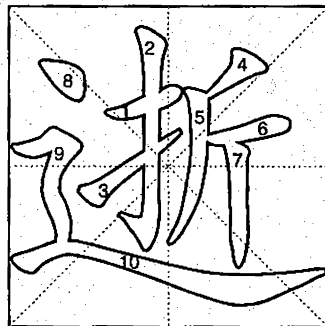

逝 shì 1395

### 识 shí

①know ②knowledge  
 识别 shí'bié  
 distinguish; discern; spot  
 识货 shí'huò  
 know all about the goods  
 识破 shí'pò  
 see through; penetrate

### 实 shí

①solid ②true; real; honest  
 ③reality; fact ④fruit; seed  
 实话 shí'huà  
 truth  
 实价 shí'jià  
 actual price  
 实况转播 shí'kuàng'zhuān'bō  
 live broadcast

### 蚀 shí

①lose ②erode; corrode  
 蚀本 shí'běn  
 lose one's capital  
 蚀变 shí'biàn  
 alteration  
 蚀刻 shí'kè  
 etching

### 食 shí

①eat ②meal; food ③feed  
 ④edible ⑤eclipse  
 食道 shí'dào  
 esophagus  
 食品 shí'pǐn  
 foodstuff; food; provisions  
 食宿 shí'sù  
 board and lodging

### 什 shí

assorted; varied; miscellaneous  
 什锦 shí'jīn  
 assorted; mixed

### 示 shì

show; notify; instruct  
 示爱 shì'ài  
 show one's love  
 示意图 shì'yì'tú  
 diagrammatic sketch  
 示众 shì'zhòng  
 publicly expose

### 式 shì

①type; style ②pattern; form  
 ③ceremony; ritual ④formula  
 ⑤mood; mode  
 式样 shì'yàng  
 fashion; form; architecture

### 始 shǐ

①beginning; start ②only then;  
 not...until  
 始末 shǐ'mò  
 beginning and end  
 始终 shǐ'zhōng  
 from beginning to end  
 始祖 shǐ'zǔ  
 first ancestor

### 驶 shǐ

①sail; drive ②speed  
 驾驶 jià'shǐ  
 drive; pilot; sail

### 使 shǐ

①send; tell sb. to do sth. ②use;  
 employ; apply ③make; cause;  
 enable ④envoy; messenger  
 使馆 shǐ'guǎn  
 embassy  
 使用寿命 shǐ'yòng'shòu'mìng  
 service life  
 使者 shǐ'zhě  
 emissary; envoy

### 逝 shì

①pass ②die; pass away  
 逝世 shì'shì  
 pass away; die

### 事 shì

①matter; affair; thing; business  
 ②trouble; accident ③job; work ④  
 be engaged in  
 事故 shì'gù  
 accident; mishap  
 事件 shì'jiàn  
 incident; event  
 事实 shì'shí  
 fact

### 柿 shì

persimmon  
 柿饼 shì'bǐng  
 dried persimmon  
 柿子 shì'zi  
 persimmon  
 柿子椒 shì'zi'jiāo  
 sweet pepper

### 世 shì

①lifetime; life ②generation  
 ③age; era ④world  
 世代 shì'dài  
 for generations  
 世纪 shì'jì  
 century  
 世界 shì'jiè  
 world

### 士 shì

①bachelor ②scholar  
 ③(commendable) person  
 士兵 shì'bīng  
 rank-and-file soldiers  
 士官 shì'guān  
 warrant officer  
 士气 shì'qì  
 morale



势 shì 1396

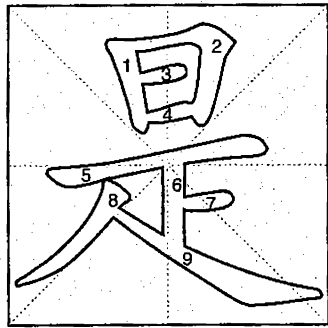

是 shì 1397

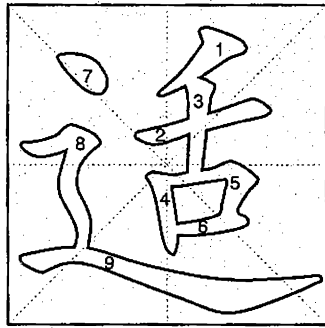

适 shì 1398

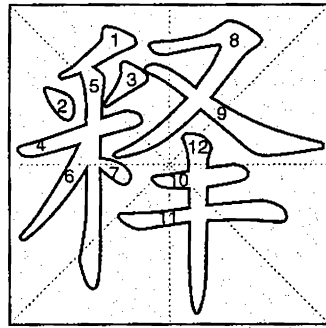

释 shì 1399

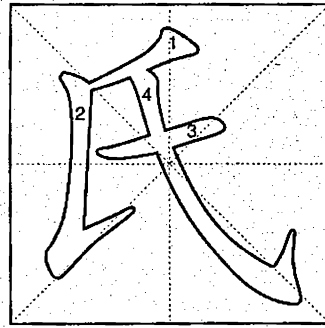

氏 shì 1400

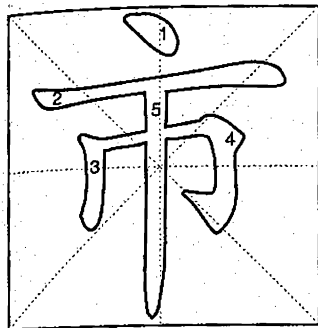

市 shì 1401

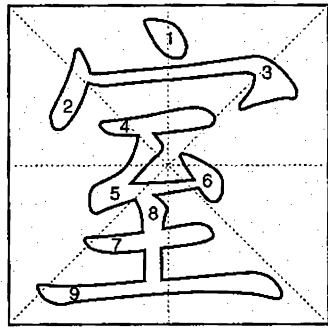

室 shì 1402

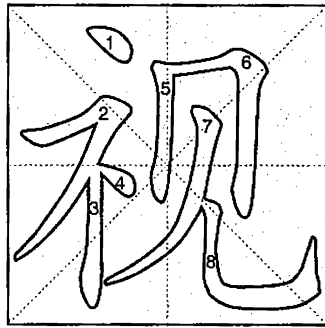

视 shì 1403

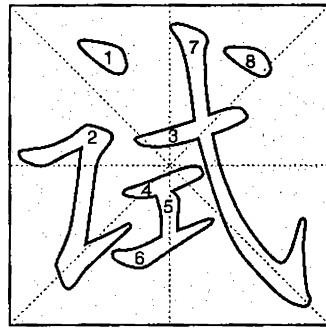

试 shì 1404

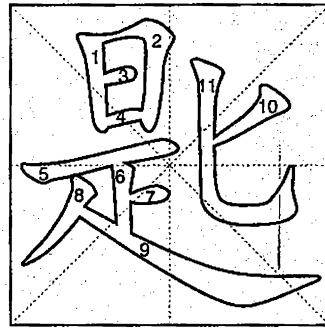

匙 shì 1405

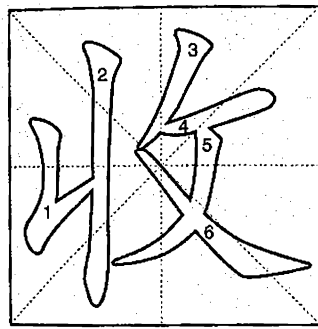

收 shōu 1406

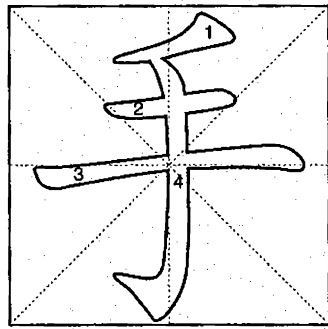

手 shǒu 1407

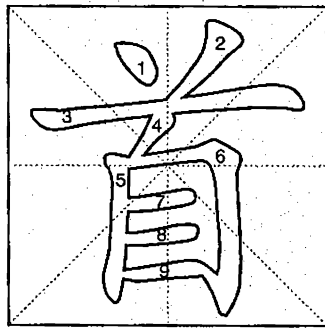

首 shǒu 1408

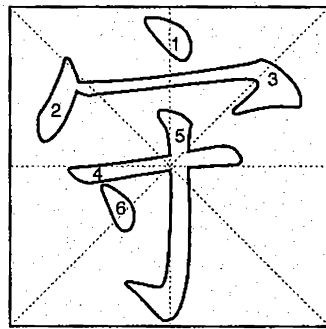

守 shǒu 1409

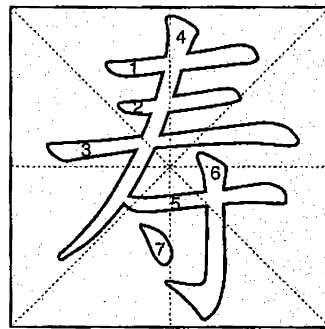

寿 shòu 1410



### 氏 shì

①family name; surname ②née  
氏族 shì'zú  
clan  
氏族社会 shì'zú'shè'huì  
clan society  
氏族制度 shì'zú'zhì'dù  
clan system

### 释 shì

①explain; elucidate ②clear up;  
dispel ③let go; be relieved of ④set  
free  
释放 shì'fàng  
release; set free  
释疑 shì'yí  
clear up (or remove) doubts  
释义 shì'yì  
explain the meaning

### 适 shì

①fit; suitable; proper ②right;  
opportune ③comfortable; well ④  
go; follow; pursue  
适当 shì'dàng  
suitable; proper; appropriate  
适口 shì'kǒu  
agreeable to the taste  
适龄 shì'líng  
of the right age

### 是 shì

①correct; right ②yes; right ③be  
是的 shì'de  
yes; right; that's it  
是非 shì'fei  
right and wrong; quarrel  
是否 shì'fǒu  
whether or not; whether; if

### 势 shì

①power; force; influence  
②momentum; tendency ③the  
outward appearance of a natural  
object  
势力 shì'li  
force; power; influence  
势利小人 shì'li'xiǎo'rén  
snob  
势态 shì'tài  
situation; circumstances

### 匙 shì

钥匙 yào'shì  
key

### 试 shì

①try; test ②examination; test  
试飞员 shì'fēi'yuán  
test pilot  
试管婴儿 shì'guǎn'yīng'ér  
test-tube baby  
试用品 shì'yòng'pǐn  
trial products

### 视 shì

①look at ②regard ③watch  
视角 shì'jiǎo  
angle of view  
视觉 shì'jué  
visual sense; vision  
视力 shì'lì  
vision; sight

### 室 shì

room  
室内 shì'nèi  
indoor; interior  
室外 shì'wài  
outdoor; outside  
室温 shì'wēn  
room temperature

### 市 shì

①market ②city; municipality  
市场 shì'chǎng  
market; bazaar  
市花 shì'huā  
flower of a city  
市长 shì'zhǎng  
mayor

### 寿 shòu

①longevity ②life; age ③birthday  
④for burial  
寿辰 shòu'chén  
birthday  
寿诞 shòu'dàn  
birthday anniversary  
寿命 shòu'mìng  
life-span; life

### 守 shǒu

①guard; defend ②keep watch  
③observe; abide by  
守护 shǒu'hù  
guard; defend  
守门 shǒu'mén  
keep goal  
守夜 shǒu'yè  
keep watch at night

### 首 shǒu

①head ②first ③leader; chief  
④bring charges against sb.  
首车 shǒu'chē  
first bus  
首日封 shǒu'rì'fēng  
first day cover  
首饰 shǒu'shì  
ornaments; jewelry

### 手 shǒu

①hand ②have in one's hand; hold  
③handy; convenient ④personally  
手表 shǒu'biǎo  
wrist watch  
手册 shǒu'cè  
handbook; manual; guide  
手机 shǒu'jī  
receiver; cellphone

### 收 shōu

①receive ②put away; take in  
③collect ④money received;  
receipts; income ⑤harvest; gather in  
收费 shōu'fèi  
collect fees; charge  
收录机 shōu'lù'jī  
radio cassette player  
收养人 shōu'yǎng'rén  
consignee

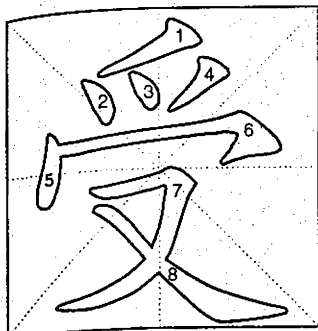

受 shòu 1411

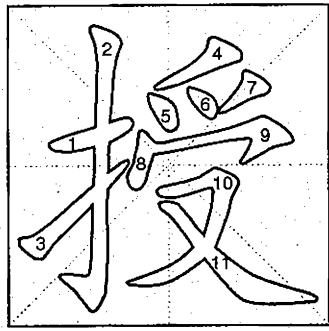

授 shòu 1412

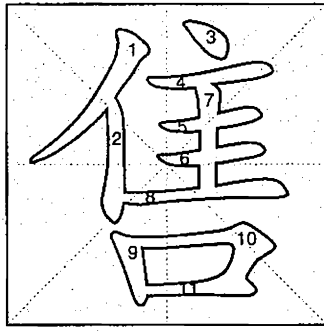

售 shòu 1413

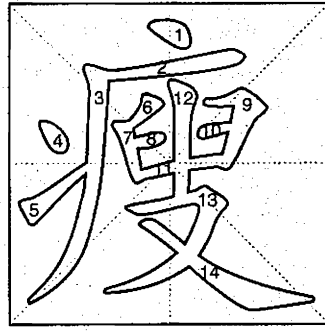

瘦 shòu 1414

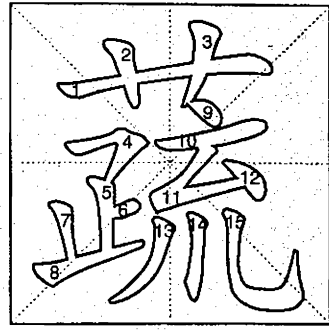

蔬 shū 1415

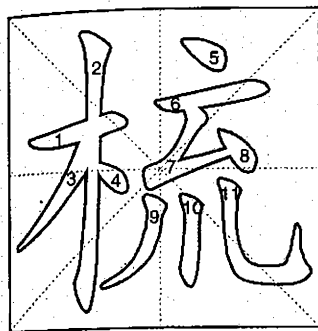

梳 shū 1416

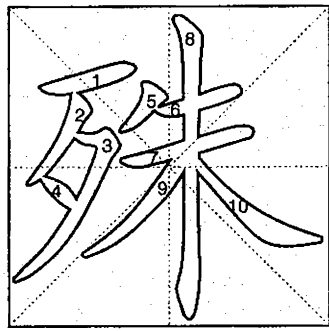

殊 shū 1417

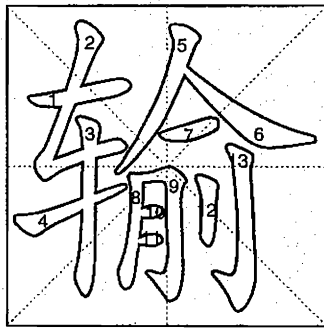

输 shū 1418

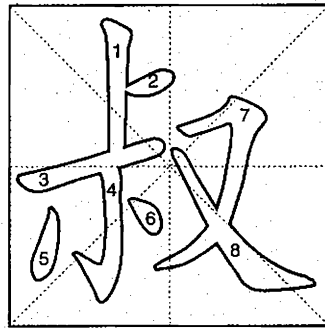

叔 shū 1419

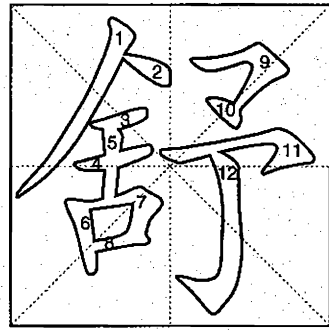

舒 shū 1420

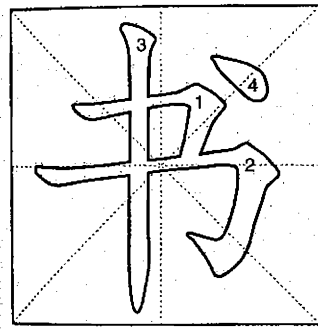

书 shū 1421

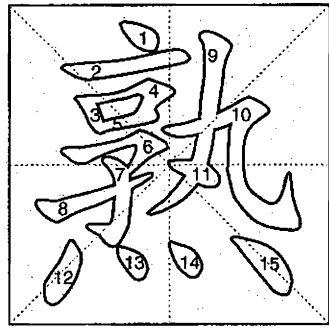

熟 shú 1422

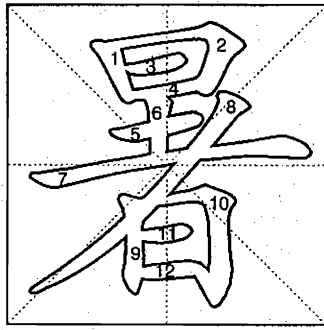

暑 shǔ 1423

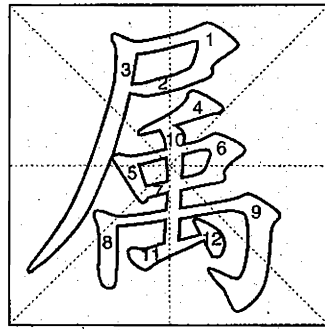

属 shǔ 1424

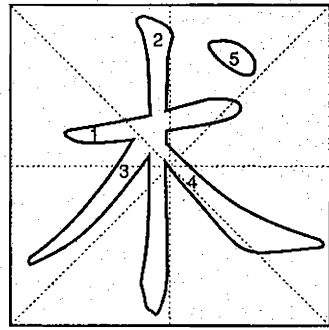

术 shù 1425

### 蔬 shū

vegetables  
蔬菜 shū' cài  
vegetables; greens  
蔬果 shū' guǒ  
vegetables and fruits

### 瘦 shòu

① thin; emaciated ② tight ③ not fertile; poor  
瘦长 shòu' cháng  
long and thin  
瘦肉 shòu' ròu  
lean meat  
瘦小 shòu' xiǎo  
thin and small

### 售 shòu

① sell ② make (one's plan, trick, etc.) work; carry out (intrigues)  
售货 shòu' huò  
sell goods  
售价 shòu' jià  
selling price  
售票处 shòu' piào' chù  
ticket office

### 授 shòu

① award; vest; confer; give  
② teach; instruct  
授奖 shòu' jiǎng  
award (give) a prize  
授权 shòu' quán  
empower; authorize  
授予 shòu' yǔ  
confer; award

### 受 shòu

① receive; accept  
② suffer; be subjected to  
③ stand; endure; bear  
受罚 shòu' fá  
be punished  
受惠国 shòu' huì' guó  
favored nation  
受伤 shòu' shāng  
be injured; be wounded

### 舒 shū

① stretch; unfold ② easy; leisurely  
舒畅 shū' chàng  
happy  
舒服 shū' fu  
comfortable  
舒适 shū' shì  
comfortable; easy; snug

### 叔 shū

father's younger brother; uncle  
叔父 shū' fu  
uncle; father's younger brother  
叔母 shū' mǔ  
wife of father's younger brother;  
aunt  
叔叔 shū' shu  
uncle

### 输 shū

① transport; convey  
② lose; be beaten; be defeated  
输出 shū' chū  
export; output  
输氧 shū' yǎng  
oxygen therapy  
输油管 shū' yóu' guǎn  
petroleum pipeline

### 殊 shū

① different  
② outstanding; special; remarkable  
③ very much; extremely  
殊不知 shū' bù' zhī  
little imagine  
殊荣 shū' róng  
special honor  
殊死 shū' sǐ  
desperate; life-and-death

### 梳 shū

① comb ② comb one's hair, etc.  
梳洗 shū' xǐ  
wash and dress  
梳妆台 shū' zhuāng' tái  
dressing table  
梳子 shū' zi  
comb

### 术 shù

① art; skill; technique  
② method; tactics  
术语 shù' yǔ  
technical terms

### 属 shǔ

① category ② genus ③ under; subordinate to ④ belong to  
属地 shǔ' dì  
possession; dependency  
属性 shǔ' xìng  
property  
属于 shǔ' yǔ  
belong to; be part of

### 暑 shǔ

heat; hot weather  
暑假 shǔ' jià  
summer vacation  
暑热 shǔ' rè  
hot summer weather  
暑天 shǔ' tiān  
hot summer days

### 熟 shú

① ripe ② cooked; done  
③ processed ④ familiar ⑤ skilled;  
experienced  
熟记 shú' jì  
learn by heart  
熟练 shú' liàn  
skilled; practised  
熟睡 shú' shuì  
sleep soundly

### 书 shū

① write ② script ③ book ④ letter  
⑤ document  
书报 shū' bào  
books and newspapers  
书目 shū' mù  
booklist; title catalogue  
书亭 shū' tíng  
bookstall

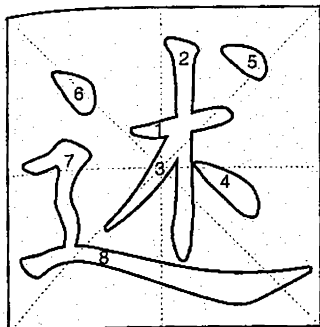

述 shù 1426

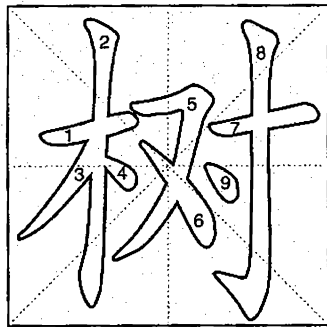

树 shù 1427

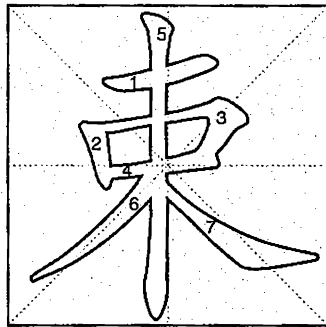

束 shù 1428

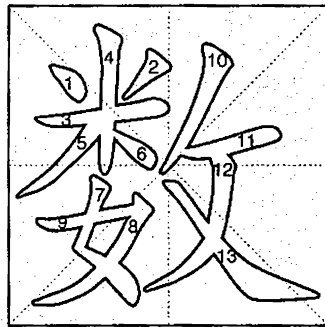

数 shù 1429

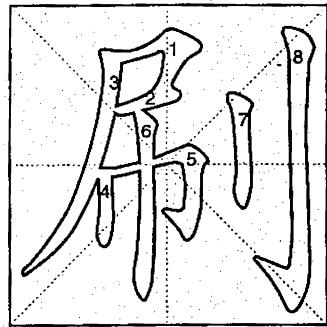

刷 shuā 1430

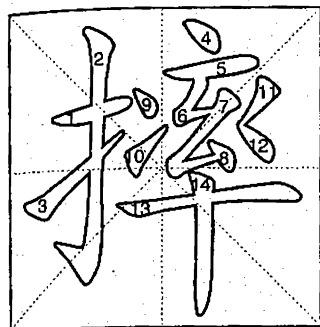

摔 shuāi 1431

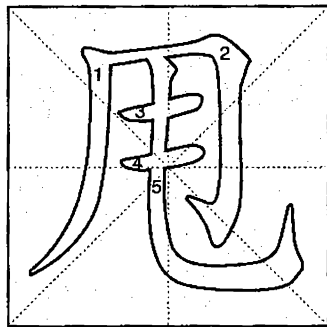

甩 shuǎi 1432

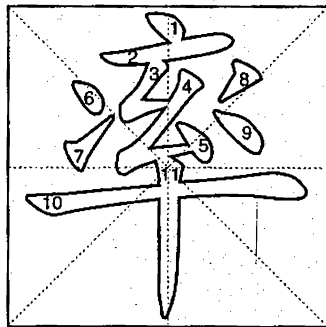

率 shuài 1433

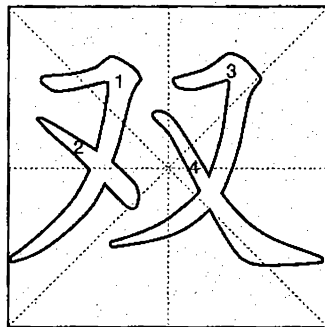

双 shuāng 1434

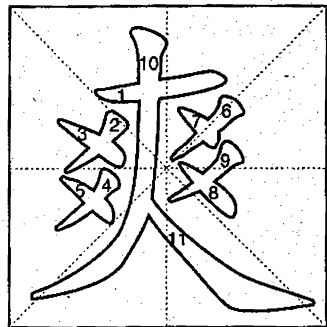

爽 shuǎng 1435

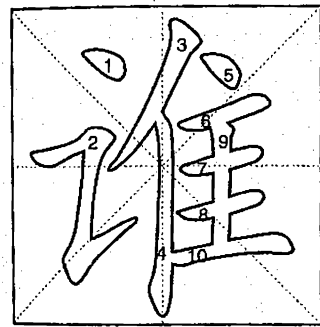

谁 shuí 1436

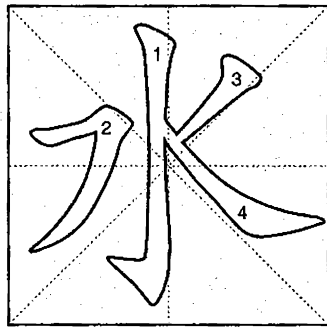

水 shuǐ 1437

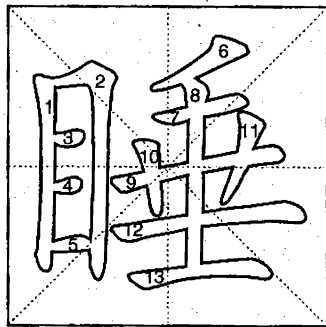

睡 shuì 1438

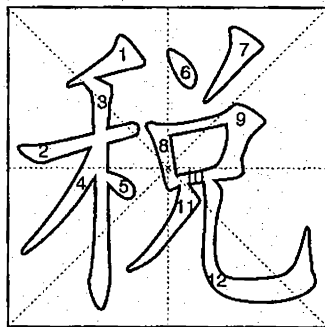

税 shuì 1439

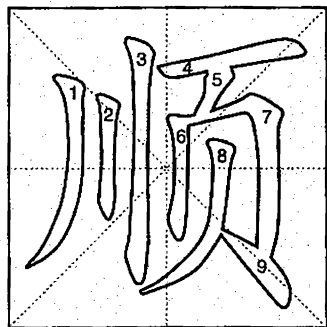

顺 shùn 1440

**刷 shuā**

- ① brush ② scrub ③ daub; paste up  
④ rustle
- 刷卡 shuā'kǎ  
swipe (a magnetic) card
- 刷牙 shuā'yá  
brush (clean) one's teeth
- 刷子 shuā'zi  
brush; scrub

**数 shù**

- ① number; figure ② several; a few
- 数据 shù'jù  
data
- 数码相机 shù'mǎ'xiàng'jī  
digital camera
- 数学 shù'xué  
mathematics

**束 shù**

- ① bind; tie ② bundle; bunch; sheaf ③ control; restrain
- 束缚 shù'fù  
tie; bind up; fetter
- 束手 shù'shǒu  
have one's hands tied
- 束手无策 shù'shǒu'wú'cè  
feel quite helpless

**树 shù**

- ① tree ② plant; cultivate ③ set up; establish; uphold
- 树立 shù'lì  
set up; establish
- 树木 shù'mù  
trees
- 树叶 shù'yè  
leaf

**述 shù**

- state; relate; narrate
- 述评 shù'píng  
review; commentary
- 述说 shù'shuō  
state; recount; narrate
- 述职 shù'zhí  
report on one's work

**爽 shuǎng**

- ① bright; clear; crisp ② frank; straightforward; openhearted ③ feel well
- 爽快 shuǎng'kuài  
refreshed; comfortable
- 爽身粉 shuǎng'shēn'fěn  
talcum powder
- 爽直 shuǎng'zhí  
frank; candid

**双 shuāng**

- ① two; twin; both; dual ② pair ③ even ④ double; twofold
- 双胞胎 shuāng'bāo'tāi  
twins
- 双方 shuāng'fāng  
both sides
- 双学位 shuāng'xué'wèi  
double degree

**率 shuài**

- ① lead; command ② rash; hasty ③ frank; straightforward ④ generally; usually
- 率领 shuài'lǐng  
lead; head; command
- 率先 shuài'xiān  
take the lead in doing sth.
- 率直 shuài'zhí  
straightforward; blunt

**甩 shuǎi**

- ① move backward and forward; swing ② throw; fling; toss ③ leave sb. behind; throw off
- 甩卖 shuǎi'mài  
off a clearance sale
- 甩手 shuǎi'shǒu  
refuse to do

**摔 shuāi**

- ① fall; tumble; lose one's balance ② hurtle down; plunge ③ cause to fall and break; break
- 摔打 shuāi'dǎ  
beat; knock; rough it
- 摔跟头 shuāi'gēn'tou  
tumble; trip up
- 摔跤 shuāi'jiāo  
tumble; wrestling

**顺 shùn**

- ① in the same direction as; with ② along ③ obey; yield to ④ suitable; agreeable ⑤ in sequence
- 顺便 shùn'biàn  
conveniently; by the way
- 顺利 shùn'lì  
smoothly; successfully
- 顺心 shùn'xīn  
satisfactory

**税 shuì**

- tax; duty
- 税单 shuì'dān  
tax receipt
- 税率 shuì'lǜ  
tax rate; tariff rate
- 税种 shuì'zhǒng  
categories of taxes

**睡 shuì**

- sleep
- 睡袋 shuì'dài  
sleeping bag
- 睡眠 shuì'mián  
rest; sleep
- 睡醒 shuì'xǐng  
wake up

**水 shuǐ**

- ① water ② a general term for rivers, lakes, seas, etc.
- 水坝 shuǐ'bà  
dam
- 水果 shuǐ'guǒ  
fruit
- 水龙头 shuǐ'lóng'tóu  
(water) tap

**谁 shuí**

- ① who ② someone; anyone
- 谁的 shuí'de  
whose

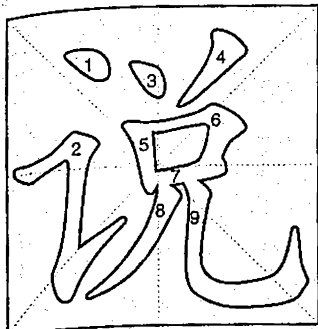

说 shuō 1441

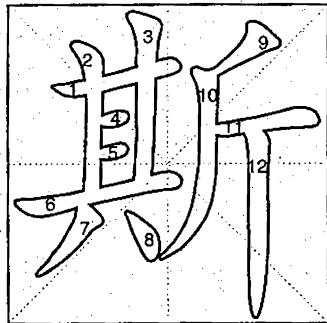

斯 sī 1442

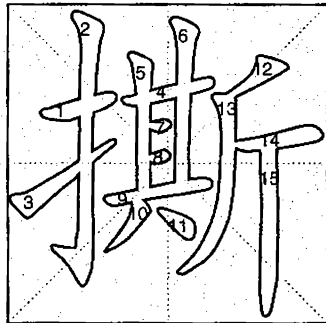

撕 sī 1443

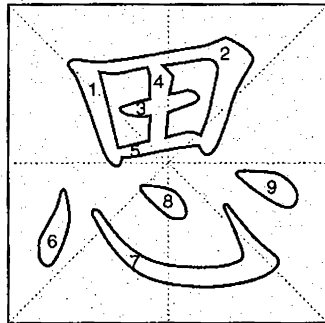

思 sī 1444

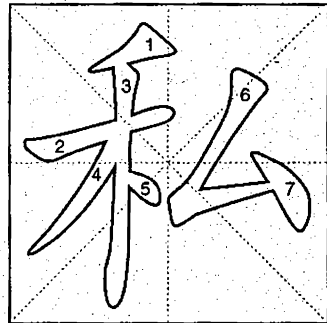

私 sī 1445

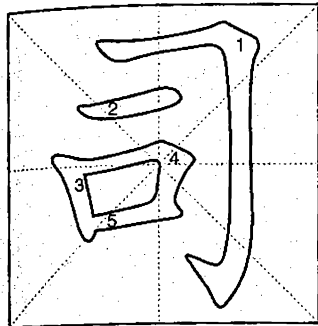

司 sī 1446

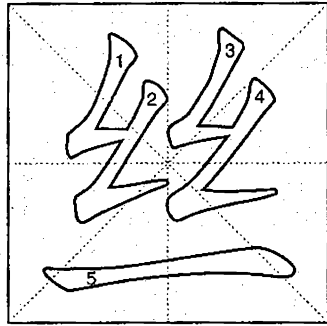

丝 sī 1447

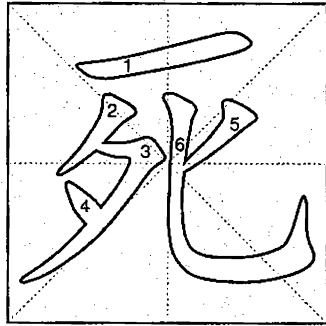

死 sǐ 1448

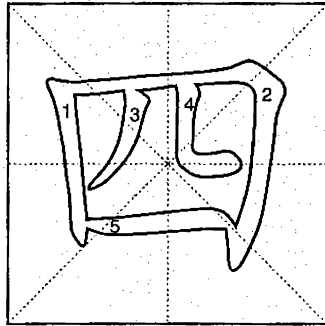

四 sì 1449

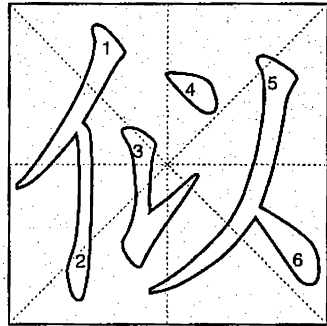

似 sì 1450

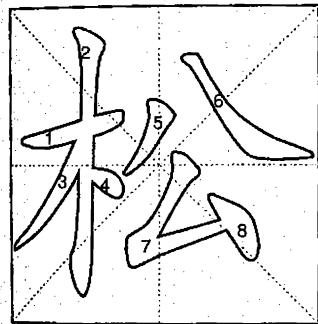

松 sōng 1451

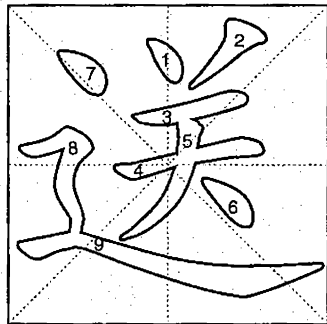

送 sòng 1452

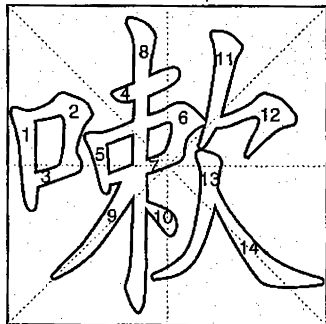

嗽 sòu 1453

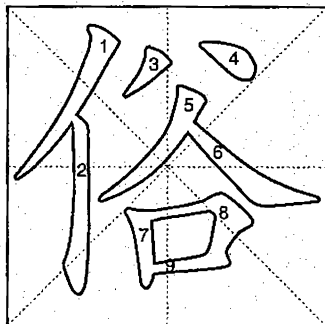

俗 sú 1454



素 sù 1455

### 私 sī

- ①personal; private ②selfish  
 ③secret ④illicit; illegal  
 私产 sī'chǎn  
 private property  
 私房 sī'fáng  
 private savings  
 私有 sī'yǒu  
 privately owned; private

### 思 sī

- ①think; consider; deliberate  
 ②think of; long for  
 ③thought; thinking  
 思路 sī'lù  
 thinking  
 思念 sī'niàn  
 long for; miss  
 思想 sī'xiǎng  
 thought; thinking; idea

### 撕 sī

- tear; rip  
 撕开 sī'kāi  
 tear upon  
 撕破 sī'pò  
 tear; rive  
 撕碎 sī'suì  
 tear; pluck; break up

### 斯 sī

- ①this;—时 at this moment  
 ②then; thus  
 斯文 sī'wén  
 refined; gentle

### 说 shuō

- ①speak; talk; say ②explain  
 ③theory; teachings; doctrine  
 ④scold  
 说谎 shuō'huǎng  
 tell a lie  
 说明书 shuō'míng'shū  
 directions; manual  
 说笑 shuō'xiào  
 chatting and laughing

### 似 sì

- ①similar; like ②seem; appear  
 似曾相识 sì'céng'xiāng'shí  
 seen to have met before  
 似乎 sì'hū  
 it seems; as if; seemingly  
 似是而非 sì'shì'ér'fēi  
 specious

### 四 sì

- four  
 四边形 sì'biān'xíng  
 quadrilateral  
 四处 sì'chù  
 all around; everywhere  
 四月 sì'yuè  
 April; the fourth moon

### 死 sǐ

- ①die ②to the death ③extremely  
 ④implacable; deadly ⑤fixed; rigid  
 ⑥impassable; closed  
 死党 sǐ'dǎng  
 diehard followers  
 死鬼 sǐ'guǐ  
 devil  
 死记 sǐ'jì  
 learn by rote

### 丝 sī

- ①silk ②a threadlike thing  
 ③a tiny bit; trace  
 丝绸 sī'chóu  
 silk cloth; silk  
 丝带 sī'dài  
 silk ribbon  
 丝巾 sī'jīn  
 silk scarf

### 司 sī

- ①take charge of; attend to; manage  
 ②department (under a ministry)  
 司法 sī'fǎ  
 administration of justice  
 司机 sī'jī  
 driver  
 司令 sī'lìng  
 commander

### 素 sù

- ①white ②plain; simple; quiet  
 ③vegetable ④native ⑤basic  
 element ⑥usually; always  
 素材 sù'cái  
 source material  
 素描 sù'miáo  
 sketch; literary sketch  
 素养 sù'yǎng  
 accomplishment

### 俗 sù

- ①custom; convention ②popular;  
 common ③vulgar ④secular; lay  
 俗名 sù'míng  
 popular name  
 俗气 sù'qì  
 vulgar; in poor taste  
 俗语 sù'yǔ  
 folk adage

### 嗽 sòu

- 咳嗽 kē'sòu  
 cough

### 送 sòng

- ①deliver; carry ②give (as a  
 present) ③see sb. off or out  
 送报 sòng'bào  
 deliver newspaper  
 送客 sòng'kè  
 to send person off  
 送行 sòng'xíng  
 see sb. off

### 松 sōng

- ①pine ②loose; slack ③loosen;  
 relax; slacken ④not hard up ⑤light  
 and flaky; soft  
 松果 sōng'guǒ  
 pine cone  
 松仁 sōng'rén  
 pine seed  
 松树 sōng'shù  
 the pine trees

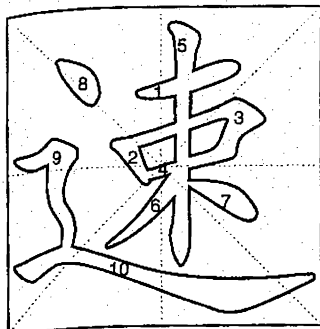

速 sù 1456

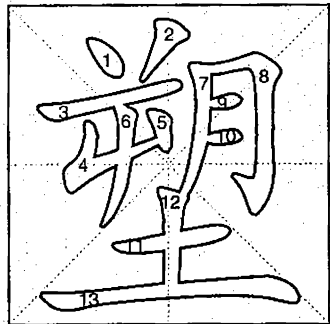

塑 sù 1457

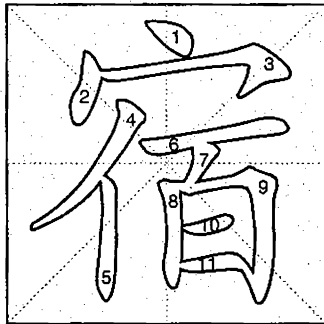

宿 sù 1458

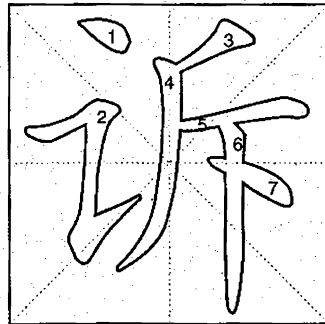

诉 sù 1459

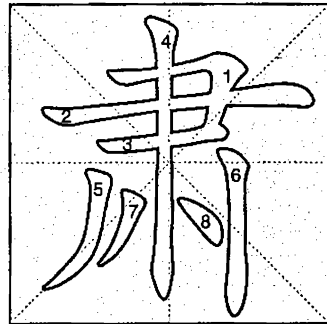

肃 sù 1460

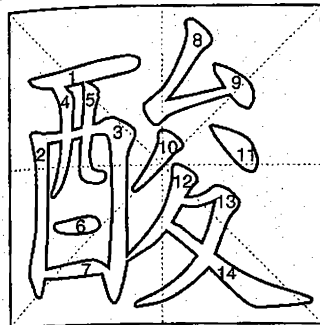

酸 suān 1461

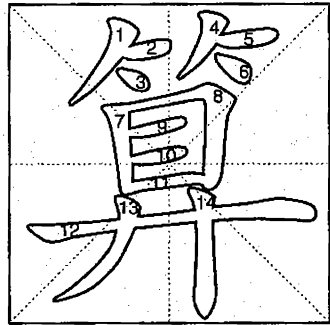

算 suàn 1462

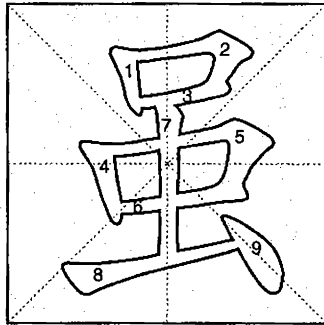

虽 suī 1463

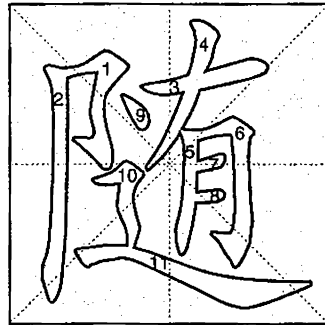

随 suí 1464

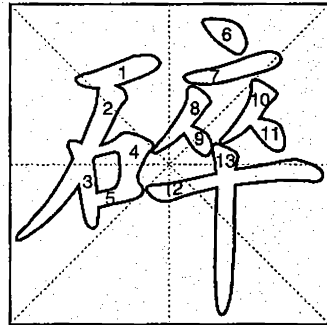

碎 suì 1465

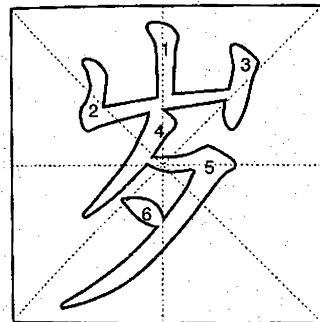

岁 suì 1466

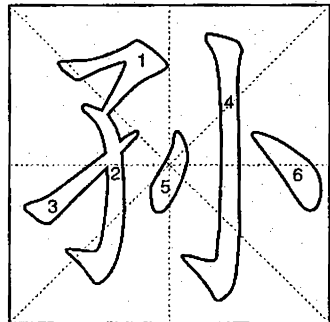

孙 sūn 1467

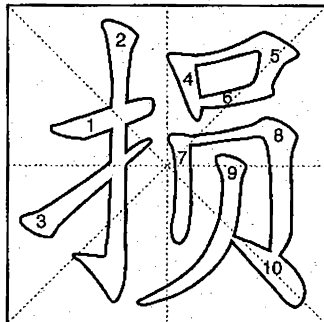

损 sǔn 1468

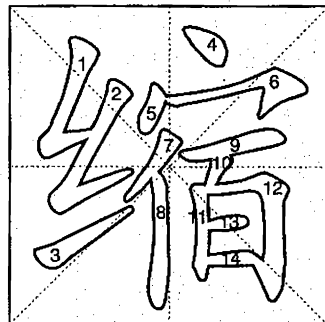

缩 suō 1469

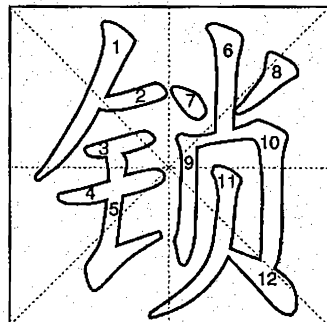

锁 suǒ 1470



### 肃 sù

①respectful ②solemn  
 肃静 sù'jìng  
 solemn silence  
 肃立 sù'lì  
 stand as a mark of respect  
 肃穆 sù'mù  
 solemn and respectful

### 诉 sù

①tell; relate; inform ②complain;  
 accuse ③appeal to  
 诉讼(法) sù'sòng(fǎ)  
 lawsuit; litigation  
 诉诸法律 sù'zhū'fǎ'lǜ  
 go to law  
 诉诸武力 sù'zhū'wǔ'lì  
 resort to force

### 宿 sù

①lodge for the night; stay overnight  
 ②longstanding; old ③veteran  
 宿舍 sù'shè  
 hostel; living quarters  
 宿营 sù'yíng  
 take up quarters  
 宿愿 sù'yuàn  
 long-cherished wish

### 塑 sù

model; mould  
 塑料 sù'liào  
 plastics  
 塑像 sù'xiàng  
 statue  
 塑造 sù'zào  
 model; mould; portray

### 速 sù

①fast; rapid; quick; speedy  
 ②speed; velocity  
 速递 sù'dī  
 express delivery  
 速冻 sù'dòng  
 quick-freeze  
 速写 sù'xiě  
 sketch; literary sketch

### 碎 suì

①break to pieces; smash  
 ②broken; fragmentary  
 ③garrulous; gabby  
 碎步 suì'bù  
 quick short steps  
 碎块 suì'kuài  
 broken bits  
 碎石 suì'shí  
 crushed stones

### 随 suí

①follow ②comply with; adapt to  
 ③let (sb. do as he likes)  
 ④alongwith (some other action)  
 随处 suí'chù  
 everywhere; anywhere  
 随从 suí'cóng  
 accompany; attend  
 随身听 suí'shēn'tīng  
 walkman

### 虽 suī

though; although; even if  
 虽然(连) suī'rán(lián)  
 though; although  
 虽死犹生 suī'sǐ'yóu'shēng  
 live on in spirit  
 虽则(连) suī'zé(lián)  
 though; although

### 算 suàn

①calculate; reckon; compute;  
 figure ②include; count ③plan;  
 calculate ④at long last; in the end  
 算命 suàn'mìng  
 fortune-telling  
 算术 suàn'shù  
 arithmetic  
 算帐 suàn'zhàng  
 do (work out) accounts

### 酸 suān

①acid ②sour ③tingle; ache  
 酸辣汤 suān'là'tāng  
 vinegar-pepper soup  
 酸雨 suān'yǔ  
 acid rain  
 酸枣 suān'zǎo  
 wild jujube

### 锁 suǒ

①lock ②lock up ③lockstitch  
 锁定 suǒ'dìng  
 keep to; finally decide; follow  
 closely  
 锁链 suǒ'liàn  
 chain; shackles; fetters  
 锁钥 suǒ'yuè  
 key; strategic gateway

### 缩 suō

①contract; shrink  
 ②draw back; withdraw; recoil  
 缩微 suō'wēi  
 micro; micrify  
 缩小 suō'xiǎo  
 reduce; lessen; narrow  
 缩写 suō'xiě  
 abbreviation; abridge

### 损 sǔn

①decrease; lose ②harm; damage  
 损坏 sǔn'huài  
 damage; injure  
 损伤 sǔn'shāng  
 harm; damage; injure  
 损失 sǔn'shī  
 lose; loss; damage

### 孙 sūn

①grandson ②generations below  
 that of the grandchild  
 孙女 sūn'nǚ  
 granddaughter  
 孙子 sūn'zi  
 grandson

### 岁 suì

①year ②year (of age)  
 岁末 suì'mò  
 the end of the year  
 岁数 suì'shu  
 age; years  
 岁月 suì'yuè  
 years

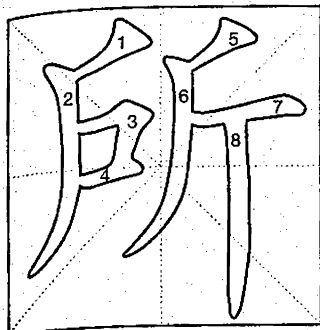

所 suǒ 1471

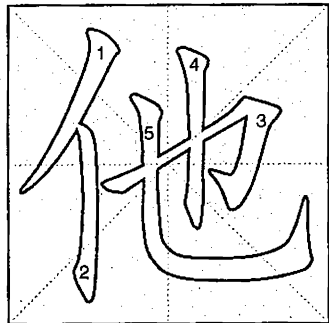

他 tā 1472

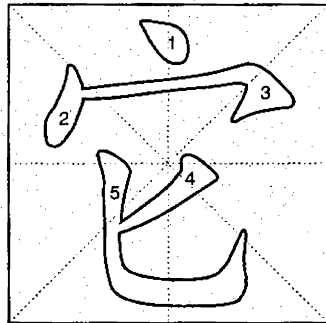

它 tā 1473

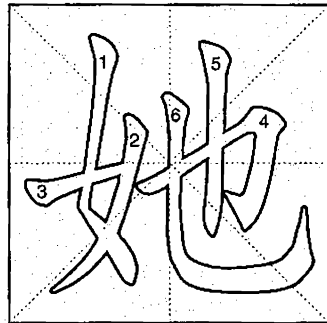

她 tā 1474

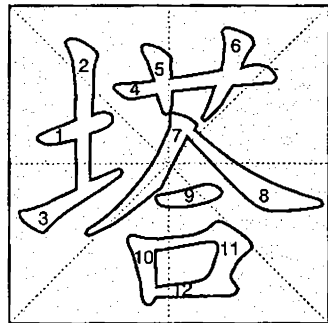

塔 tǎ 1475

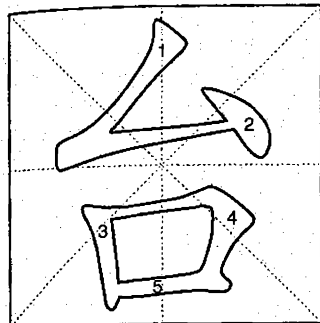

台 tái 1476

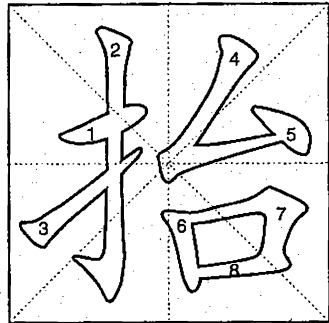

抬 tái 1477

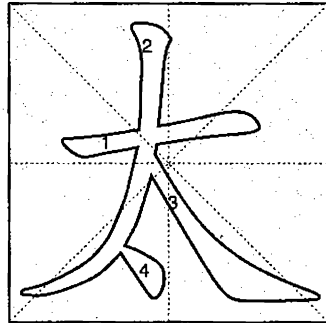

太 tài 1478

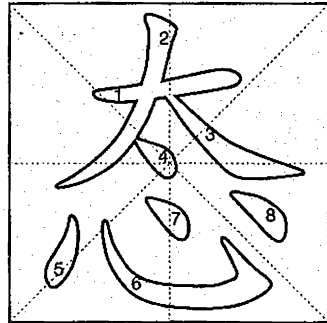

态 tài 1479

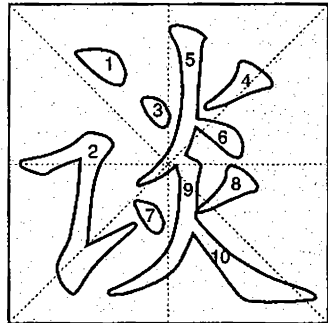

谈 tán 1480

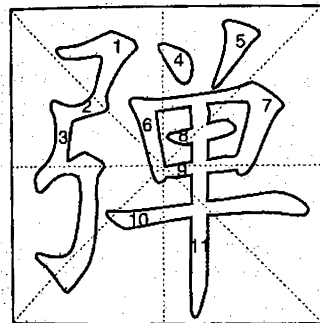

弹 tán 1481

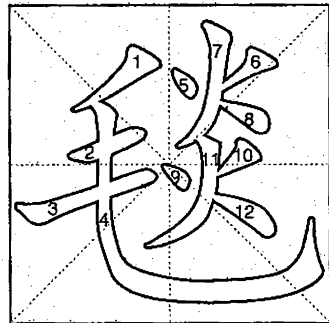

毯 tǎn 1482

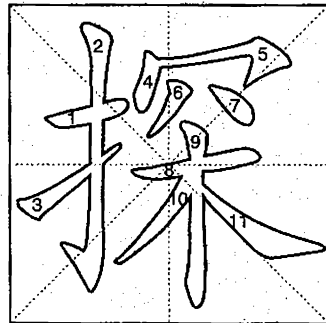

探 tàn 1483

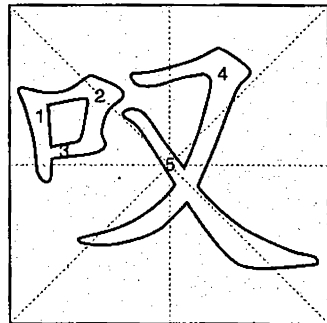

叹 tàn 1484

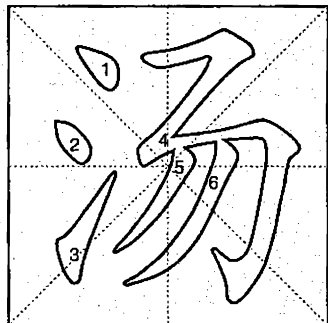

汤 tāng 1485

### 塔 tǎ

①pagoda ②tower  
塔吊 tǎ'diào  
tower crane  
塔楼 tǎ'lóu  
tower  
塔台(航空) tǎ'tái(háng'kōng)  
control tower

### 她 tā

she  
她们 tā'men  
they  
她们自己 tā'men'zìjǐ  
themselves  
她自己 tā'zìjǐ  
herself

### 它 tā

it  
它们 tā'men  
they  
它自己 tā'zìjǐ  
itself

### 他 tā

①he ②other; another; some other  
他们 tā'men  
they  
他乡 tā'xiāng  
an alien land  
他自己 tā'zìjǐ  
himself

### 所 suǒ

place  
所有权 suǒ'yǒu'quán  
proprietorship  
所有制 suǒ'yǒu'zhì  
ownership  
所在地 suǒ'zài'dì  
location; seat; site

### 谈 tán

①talk; chat; discuss  
②what is said or talked about  
谈话 tán'huà  
conversation; talk  
谈恋爱 tán'liàn'ài  
be lovers  
谈心 tán'xīn  
heart-to-heart talk

### 态 tài

①form; appearance; condition  
②state ③voice  
态度 tài'dù  
manner; attitude  
态势 tài'shì  
state; situation; posture

### 太 tài

①highest; greatest; remotest  
②excessively; too; over  
③extremely ④very  
太太 tài'tai  
Mrs.; madame; lady  
太阳 tài'yáng  
the sun; sunshine  
太阳镜 tài'yáng'jìng  
sunglasses

### 抬 tái

①lift; raise ②carry  
抬杠 tái'gàng  
bicker; wrangle  
抬高 tái'gāo  
raise; lift  
抬头 tái'tóu  
raise one's head

### 台 tái

①platform; stage; terrace  
②stand; support ③table; desk  
④broadcasting station  
台灯 tái'dēng  
desk lamp; table lamp  
台风 tái'fēng  
typhoon  
台历 tái'lì  
desk calendar

### 汤 tāng

①hot water ②soup; broth  
汤匙 tāng'chí  
tablespoon; soup spoon  
汤面 tāng'miàn  
noodles in soup  
汤碗 tāng'wǎn  
soup bowl

### 叹 tàn

①sigh  
②exclaim in admiration; acclaim  
叹词 tàn'cí  
interjection; exclamation  
叹息 tàn'xī  
heave a sigh; sigh  
叹惜 tàn'xī  
sigh with regret; lament

### 探 tàn

①try to find out; explore; sound  
②scout; spy; detective  
③visit ④stretch forward  
探病 tàn'bìng  
visit the sick  
探险 tàn'xiǎn  
make explorations  
探照灯 tàn'zhào'dēng  
searchlight

### 毯 tǎn

blanket; rug; carpet  
毯子 tǎn'zi  
blanket

### 弹 tán

①shoot; send forth ②spring; leap  
③flick; flip ④fluff; tease ⑤play (a  
stringed musical instrument)  
弹劾 tán'hé  
impeach  
弹力 tán'lì  
elastic force; elasticity  
弹奏 tán'zòu  
play; pluck

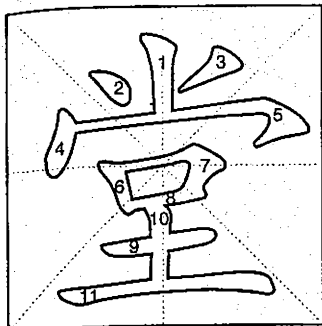

堂 táng 1486

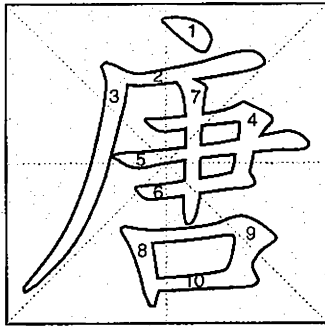

唐 táng 1487

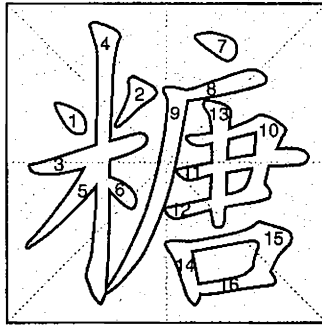

糖 táng 1488

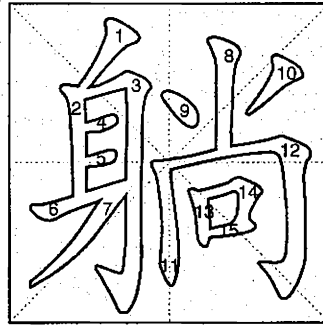

躺 tǎng 1489

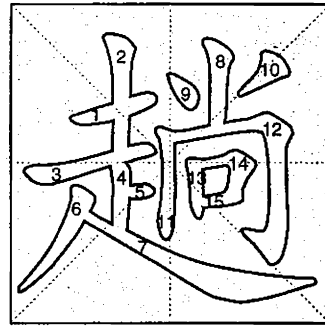

趟 tàng 1490

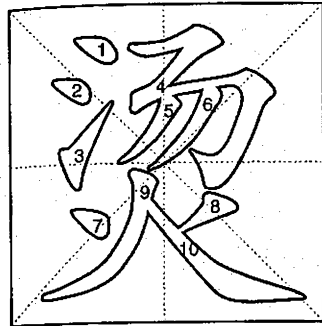

烫 tàng 1491

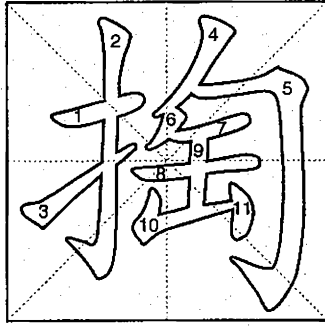

掏 tāo 1492



涛 tāo 1493

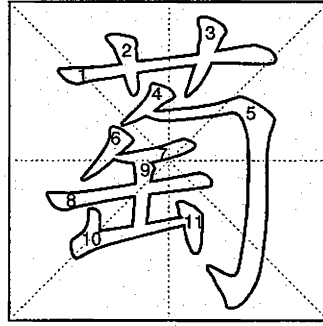

萄 táo 1494

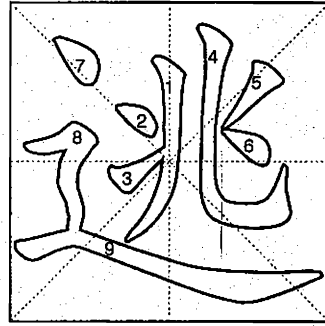

逃 táo 1495

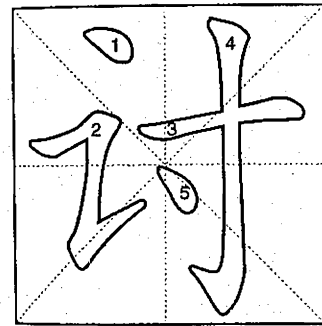

讨 tǎo 1496

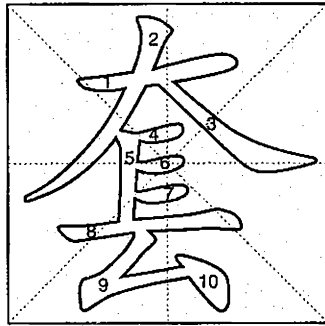

套ào 1497

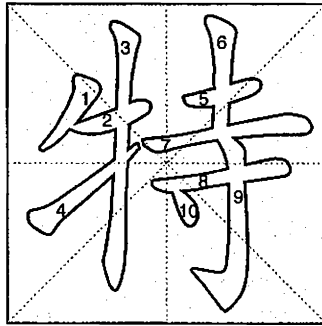

特 tè 1498

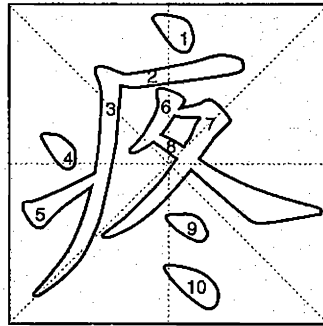

疼 téng 1499

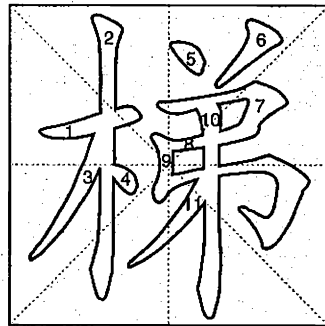

梯 tī 1500

**趟 tàng**

number of times; line

**躺 tǎng**

lie; recline

躺倒 tǎng'dǎo

lie down

躺椅 tǎng'yǐ

deck chair; sling chair

**糖 táng**

①sugar ②sugared ③sweets; candy

糖果 táng'guǒ

sweets; candy

糖浆 táng'jiāng

syrup

糖尿病 táng'niào'bìng

diabetes

**唐 táng**

the Tang Dynasty (618~907)

唐人街 táng'rén'jiē

Chinatown

唐三彩 táng'sān'cǎi

tri-colored glazed pottery of the

Tang Dynasty

唐突 táng'tū

brusque; rude; offensive

**堂 táng**

①the main room of a house ②a hall for a specific purpose ③court of law ④relationship between cousins, etc.

堂堂正正 táng'táng'zhèng'zhèng

open and above-board

堂屋 táng'wū

central room

堂兄弟 táng'xiōng'dì

cousins (m.)

**逃 táo**

①run away; escape; flee

②evade; dodge; shirk; escape

逃奔 táo'bèn

run away to

逃犯 táo'fàn

escaped criminal

逃税人 táo'shuì'rén

tax dodger

**萄 táo**

葡萄 pú'táo

grape

**涛 tāo**

great waves; billows

波涛 bō'tāo

billows, great waves

**掏 tāo**

①draw out; pull out; fish out

②dig (a hole, etc.); hollow out

③steal from sb.'s pocket

掏井 tāo'jǐng

dredge a well

掏腰包 tāo'yāo'bāo

foot a bill

**烫 tàng**

①scald; burn ②heat up in hot water; warm ③very hot ④iron; press

⑤perm

烫发 tàng'fà

perm

烫金 tàng'jīn

gilding; bronzing

烫伤 tàng'shāng

scald

**梯 tī**

①ladder; steps; stairs ②terraced

梯队 tī'duì

echelon formation

梯级 tī'jí

stair; step

梯子 tī'zi

stepladder

**疼 téng**

①ache; pain; sore

②love dearly; be fond of

疼爱 téng'ài

be very fond of

疼痛 téng'tòng

pain; painful

**特 tè**

①special; particular; unusual; exceptional ②for a special purpose; specially ③secret agent; spy

特产 tè'chǎn

special local product

特色 tè'sè

characteristic

特赦 tè'shè

special pardon

**套ào**

①sheath; case; cover; sleeve

②cover with; slip over; encase in

③that which covers (other garments, etc.) ④overlap; interlink

套汇 tào'huì

arbitrage of exchange

套色 tào'sè

colour process

套装 tào'zhuāng

a suit of clothes

**讨 tǎo**

①send armed forces to suppress

②denounce; condemn ③demand;

ask for; beg for ④marry (a woman)

讨价还价 tǎo'jià'huán'jià

bargain; haggle

讨论 tǎo'lùn

discuss; talk over

讨厌 tǎo'yàn

disagreeable; nasty

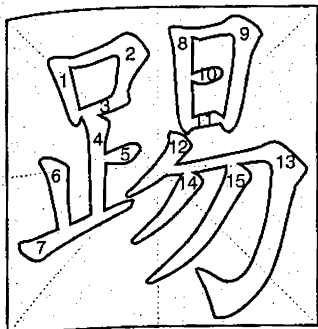

踢 tī 1501

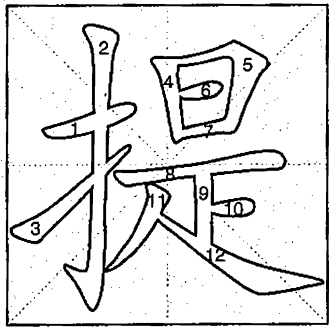

提 tí 1502

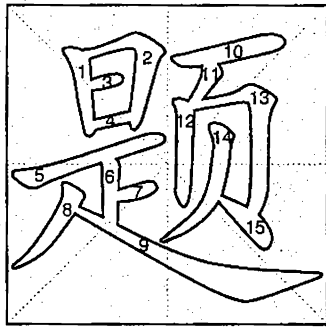

题 tí 1503

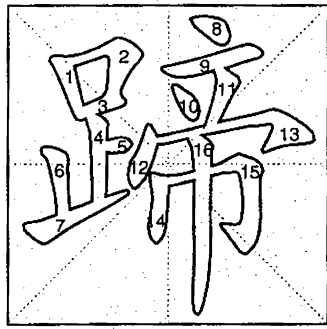

蹄 tí 1504

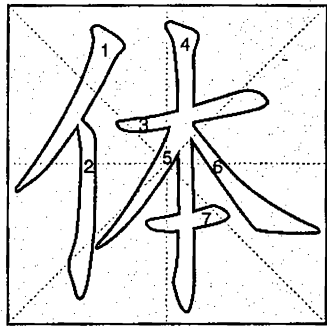

体 tǐ 1505

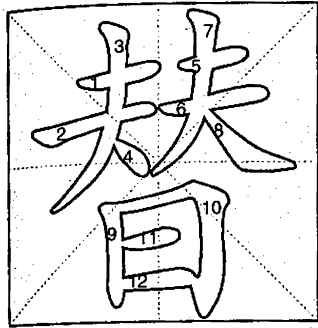

替 tì 1506

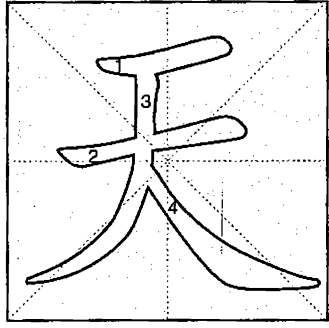

天 tiān 1507

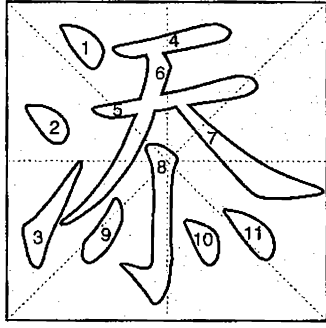

添 tiān 1508

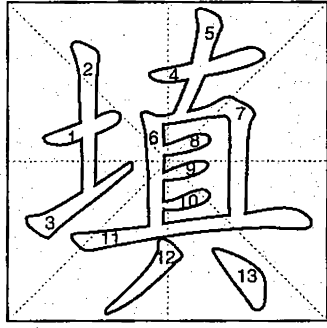

填 tián 1509

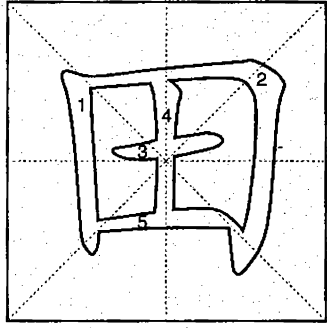

田 tián 1510

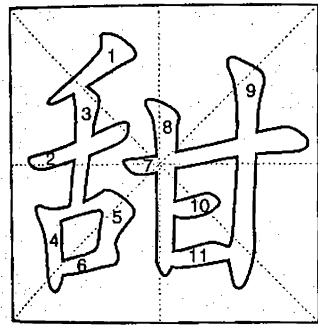

甜 tián 1511

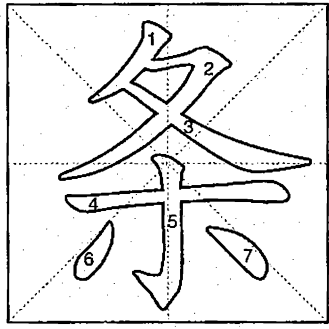

条 tiáo 1512

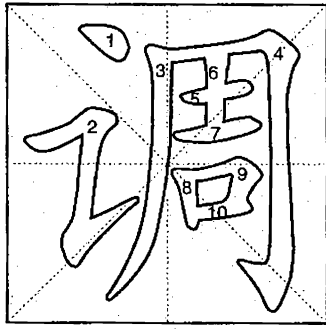

调 tiáo 1513

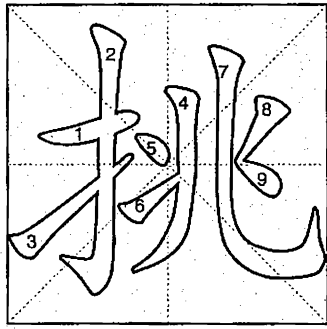

挑 tiǎo 1514

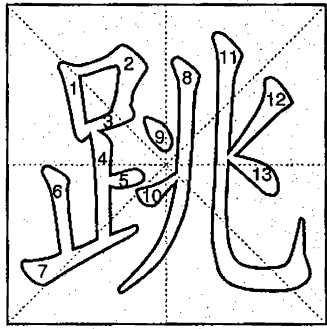

跳 tiào 1515

### 体 tǐ

①body; part of the body ②(state of a) substance ③ style; form ④ personally do or experience sth.

体温 tǐ wēn

temperature

体恤衫 tǐ xù shān

T-shirt

体重 tǐ zhòng

(body) weight

### 蹄 tí

hoof

蹄筋 tí jīn

tendons of beef, mutton or pork

蹄子 tí zi

hoof

### 题 tí

topic; subject

题材 tí cái

subject matter; theme

题名 tí míng

autograph; title

题目 tí mù

title; subject; topic

### 提 tí

①carry ②lift; raise; promote

③shift to an earlier time; move up a date ④bring up; raise ⑤draw out; extract

提案 tí'àn

motion; proposal

提包 tí'bāo

hand bag; shopping bag

提出 tí'chū

put forward; advance

### 踢 tī

①kick ②play (football); kick

### 田 tián

field; farmland

### 填 tián

①fill; stuff ②write; fill in

填表 tián biǎo

fill in a form

填补 tián bǔ

fill

填写 tián xiě

fill in; write

### 添 tiān

add; increase

添补 tiān bǔ

replenish; get more

添丁 tiān dīng

give birth to a baby

添加剂 tiān jiā jì

additive

### 天 tiān

①sky; heaven ②overhead ③day

④a period of time in a day

⑤season ⑥weather ⑦nature

天敌 tiān dí

natural enemy

天气 tiān qì

weather

天意 tiān yì

God's will

### 替 tì

① take the place of; replace; substitute for ②for; on behalf of

替补 tì bǔ

replace; substitute for

替换 tì huàn

replace; substitute for

替身 tì shēn

substitute; replacement

### 跳 tiào

①jump; leap; spring; bounce

②move up and down; beat

③skip (over); make omissions

跳板 tiào bǎn

gangplank; springboard

跳高 tiào gāo

high jump

跳水 tiào shuǐ

diving

### 挑 tiǎo

① push sth. up with a pole or stick; raise ②poke; pick ③instigate

挑拨 tiǎo bō

instigate; incite

挑唆 tiǎo suō

abet

挑战 tiǎo zhàn

challenge to battle

### 调 tiào

①mix; adjust ②suit well; fit in perfectly ③mediate ④tease; provoke

调价 tiào jià

readjust prices

调皮 tiào pí

naughty; mischievous

调匀 tiào yún

mix well

### 条 tiáo

①twig ②a long narrow piece; strip; slip ③item; article ④order

条件 tiáo jiàn

condition; term

条形码 tiáo xíng mǎ

bar code

条约 tiáo yuē

treaty; pact

### 甜 tián

①sweet; honeyed ②sound

甜菜 tián cài

beet; beetroot

甜点 tián diǎn

dessert

甜食 tián shí

sweet food; sweetmeats

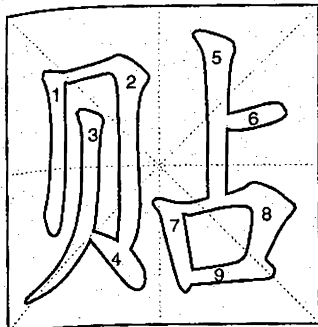

贴 tiē 1516

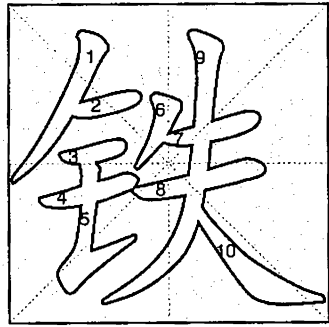

铁 tiě 1517

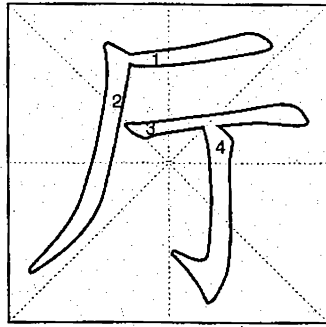

斤 jīn 1518

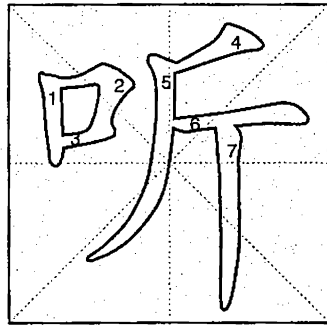

听 tīng 1519

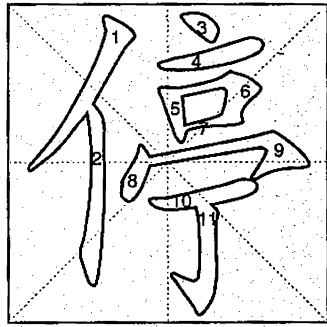

停 tíng 1520

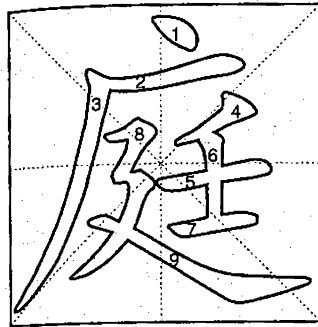

庭 tíng 1521

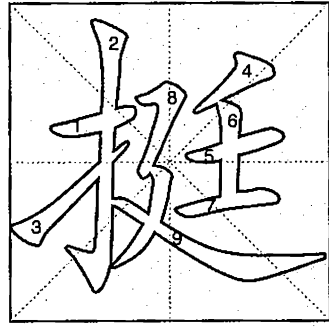

挺 tǐng 1522

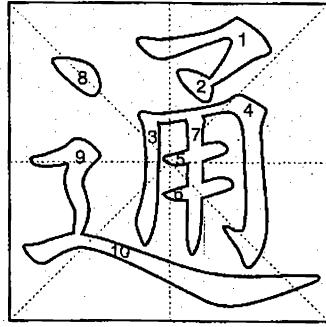

通 tōng 1523

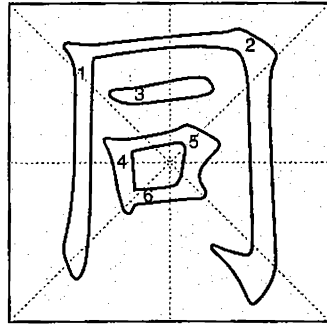

同 tóng 1524

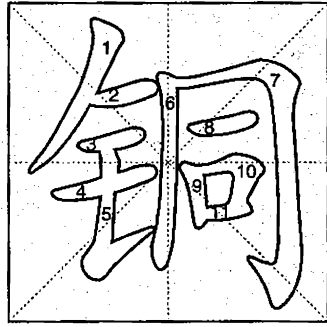

铜 tóng 1525

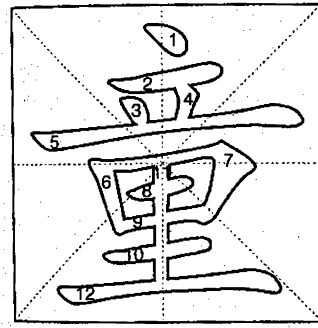

童 tóng 1526

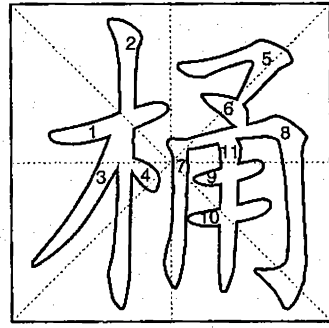

桶 tǒng 1527

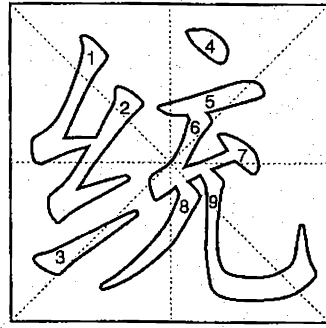

统 tǒng 1528

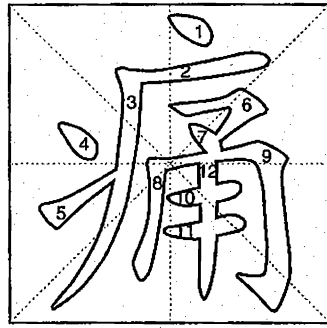

痛 tòng 1529

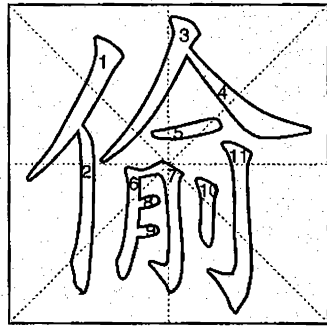

偷 tōu 1530



### 停 tíng

- ①stop; cease; halt; pause  
 ②stop over; stay ③(of cars) be parked; (of ships) lie at anchor  
 停电 tíng'diàn  
 power cut  
 停工 tíng'gōng  
 stop work; shut down  
 停火 tíng'huǒ  
 cease fire

### 听 tīng

- ①listen; hear ②heed; obey  
 ③allow; let ④tin; can  
 听从 tīng'cóng  
 obey; heed; comply with  
 听见 tīng'jiàn  
 hear  
 听说 tīng'shuō  
 be told; hear of

### 厅 tīng

- ①hall ②office ③a government department at the provincial level

### 铁 tiě

- ①iron ②arms; weapon ③hard or strong as iron ④ indisputable; unalterable ⑤resolve; determine  
 铁锤 tiě'chuí  
 hammer  
 铁轨 tiě'guǐ  
 rail  
 铁门 tiě'mén  
 iron gate

### 贴 tiē

- paste; stick; glue; keep close to; subsidies; allowance  
 贴标签 tiē'biāo'qiān  
 put label on  
 贴息 tiē'xī  
 pay interest; discount  
 贴心 tiē'xīn  
 intimate; close

### 铜 tóng

- copper  
 铜版纸 tóng'bǎn'zhǐ  
 art paper  
 铜币 tóng'bì  
 copper coin  
 铜管乐队 tóng'guǎn'yuè'duì  
 brass band

### 同 tóng

- ①same; alike; similar ②be the same as ③together; in common  
 ④with  
 同班 tóng'bān  
 in the same class  
 同年 tóng'nián  
 the same year  
 同时 tóng'shí  
 at the same time

### 通 tōng

- ①open; through ②poke; jab  
 ③lead to; go to ④connect; communicate ⑤notify; tell ⑥understand; know ⑦authority; expert  
 通读 tōng'dú  
 read over  
 通过 tōng'guò  
 pass through; get past  
 通关 tōng'guān  
 clear the customs

### 挺 tǐng

- ①straight; erect; stiff ②stick out; straighten up (physically) ③endure; stand; hold out  
 挺拔 tǐng'bá  
 tall and straight  
 挺进 tǐng'jìn  
 push forward  
 挺直 tǐng'zhí  
 straight and upright

### 庭 tíng

- ①front courtyard; front yard  
 ②law court  
 庭园 tíng'yuán  
 flower garden; grounds  
 庭院 tíng'yuàn  
 courtyard  
 庭长 tíng'zhǎng  
 the president of a court

### 偷 tōu

- ①steal; pilfer; make off with ②stealthily; secretly; on the sly ③find (time)  
 偷窃 tōu'qiè  
 steal; pilfer; thief  
 偷税 tōu'shuì  
 evade taxes  
 偷听 tōu'tīng  
 eavesdrop; bug; tap

### 痛 tòng

- ①ache; pain ②sadness  
 ③extremely; deeply  
 痛哭 tòng'kū  
 cry bitterly; wail  
 痛快 tòng'kuài  
 very happy; delighted  
 痛心 tòng'xīn  
 pained; distressed

### 统 tǒng

- ①interconnected system  
 ②gather into one; unite  
 统计 tǒng'jì  
 statistics; add up; count  
 统统 tǒng'tǒng  
 all; completely; entirely  
 统治 tǒng'zhì  
 rule; dominate

### 桶 tǒng

- tub; pail; bucket; keg; barrel

### 童 tóng

- ①child: 牧-cowherd; shepherd boy ②unmarried; virgin: ~男 virgin boy ~女 virgin; maiden  
 童工 tóng'gōng  
 child labourer  
 童话 tóng'huà  
 fairy tales  
 童心 tóng'xīn  
 childlike innocence

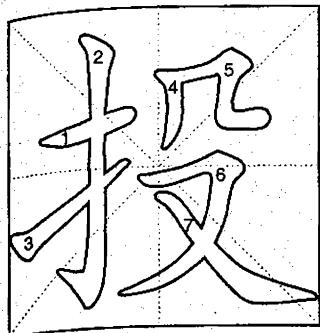

投 tóu 1531

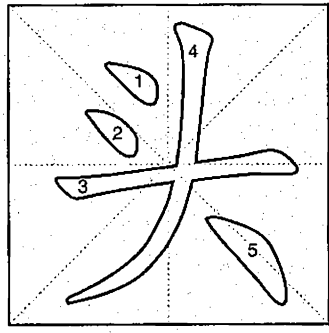

头 tóu 1532

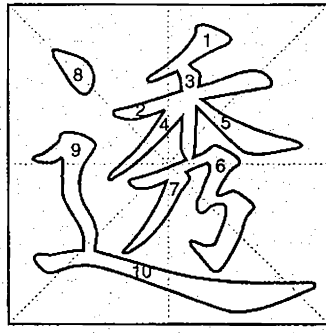

透 tòu 1533

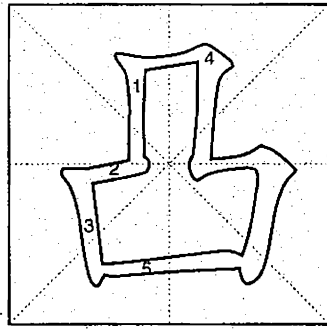

凸 tū 1534

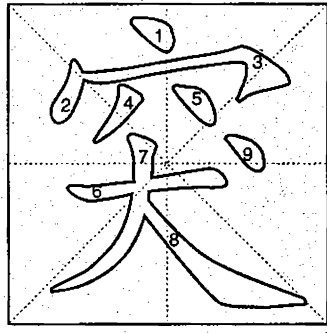

突 tū 1535



图 tú 1536



徒 tú 1537

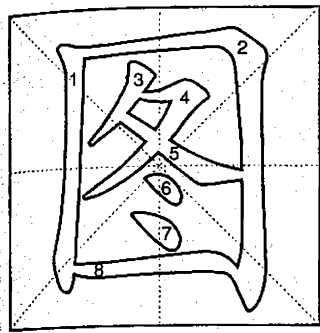
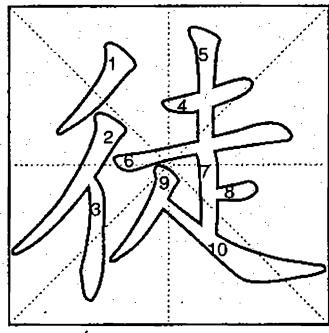
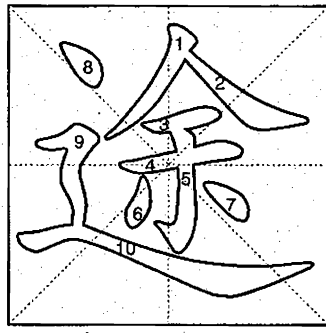

途 tú 1538

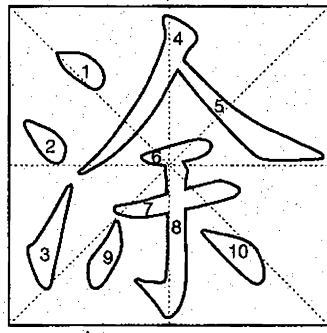

涂 tú 1539

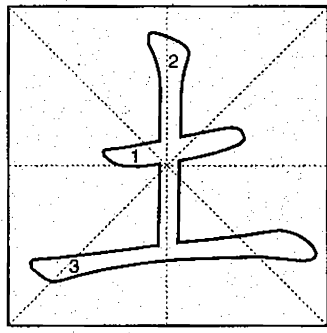

土 tǔ 1540

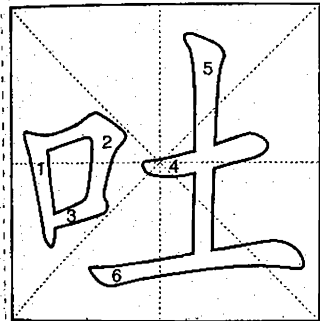

吐 tǔ 1541

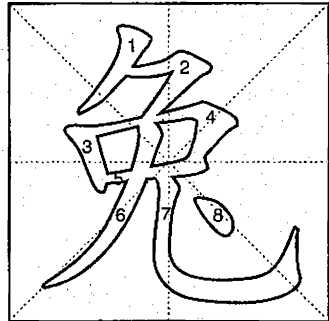

兔 tù 1542

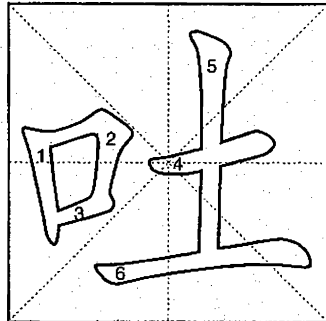

吐 tù 1543

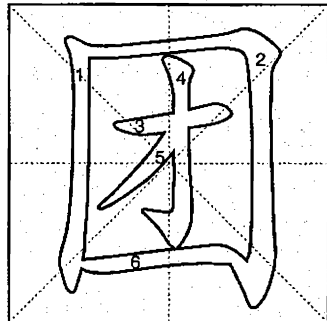

团 tuán 1544

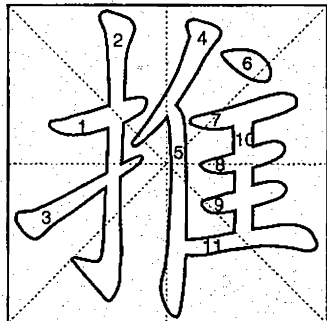

推 tuī 1545

### 突 tū

- ①dash forward; charge  
②sudden; abrupt  
突变 tū'biàn  
sudden change  
突破 tū'pò  
break through  
突然 tū'rán  
suddenly; abruptly

### 凸 tū

- protruding; raised  
凸版印刷 tū'bǎn'yìn'shuā  
letterpress  
凸版纸 tū'bǎn'zhǐ  
printing paper  
凸镜 tū'jìng  
convex mirror

### 透 tòu

- ①penetrate; pass through  
②fully; thoroughly  
透亮 tòu'liàng  
bright; transparent  
透明 tòu'míng  
transparent  
透视 tòu'shì  
perspective; fluoroscopy

### 头 tóu

- ①head ②hair ③top; end  
④beginning or end ⑤remnant;  
⑥chief ⑦side; aspect ⑧first  
头版 tóu'bǎn  
front page  
头发 tóu'fǎ  
hair  
头巾 tóu'jīn  
scarf; kerchief

### 投 tóu

- ①throw; fling; hurl ②put in;  
drop ③throw oneself into (a river,  
well, etc. to commit suicide) ④send  
投递员 tóu'dì'yuán  
postman; letter carrier  
投票 tóu'piào  
vote; cast a vote  
投资 tóu'zī  
invest; investment

### 土 tǔ

- ①soil; earth ②land; ground  
③local; native ④homemade  
⑤unrefined; unenlightened  
土产 tǔ'chǎn  
local product  
土地 tǔ'dì  
land; ground; territory  
土豆 tǔ'dòu  
potato

### 涂 tú

- ①spread on; apply; smear  
②scribble; scrawl ③blot out  
涂改 tú'gǎi  
alter  
涂料 tǔ'liào  
coating; paint  
涂写 tǔ'xiě  
scribble; scrawl

### 途 tú

- way; road; route  
途程 tú'chéng  
road; way; course  
途经 tú'jīng  
by way of; via  
途径 tú'jìng  
way; channel

### 徒 tú

- ①on foot ②empty; bare ③  
merely; only ④in vain; to no avail  
⑤apprentice; pupil  
徒步 tú'bù  
on foot  
徒工 tú'gōng  
apprentice  
徒手 tú'shǒu  
bare-handed; unarmed

### 图 tú

- ①picture; drawing; chart; map  
②scheme; plan; attempt ③pursue;  
seek ④intention; intent  
图案 tú'àn  
pattern; design  
图书 tú'shū  
book  
图纸 tú'zhǐ  
blueprint; drawing

### 推 tuī

- ①push; shove ②turn (a mill or  
grindstone); grind ③cut; pare or cut  
sb.'s hair (with clippers)  
推销 tuī'xiāo  
promote sales; market  
推行 tuī'xíng  
carry out; practice  
推选 tuī'xuǎn  
elect; choose

### 团 tuán

- ①round; circular ②sth. shaped  
like a ball ③roll (sth. into a ball)  
④unite; conglomerate  
团伙 tuán'huǒ  
gang; band  
团结 tuán'jié  
unite; rally  
团体 tuán'tǐ  
organization; group

### 吐 tù

- ①vomit; throw up ②give up  
unwillingly; disgorge (ill-gotten  
gains) ③vomit; throw up spit; give  
up unwillingly; disgorge  
吐沫 tù'mò  
saliva; spittle; spit  
吐血 tù'xiě  
spit out blood

### 兔 tù

- hare; rabbit  
兔唇〈医〉tù'chún(yī)  
harelip  
兔子 tù'zi  
hare; rabbit

### 吐 tù

- ①spit ②say; tell; pour out  
吐气 tù'qì  
feel elated and exultant  
吐弃 tù'qì  
spurn; cast aside; reject  
吐字 tù'zì  
articulate

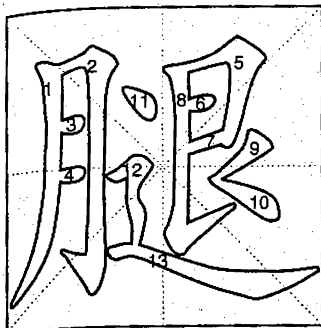

腿 tuǐ

1546

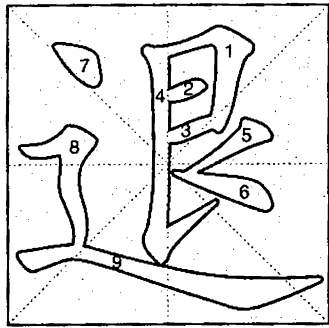

退 tuì

1547

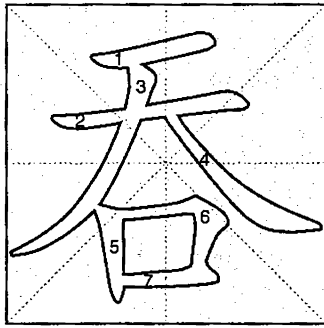

吞 tūn

1548

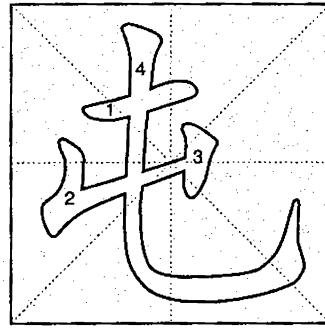

屯 tún

1549

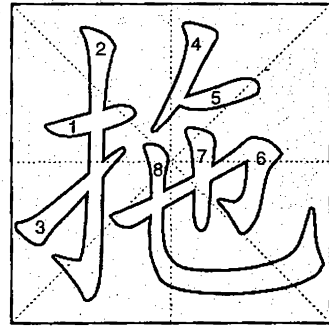

拖 tuō

1550

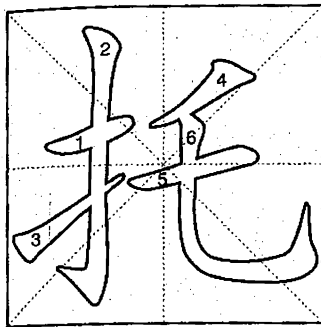

托 tuō

1551

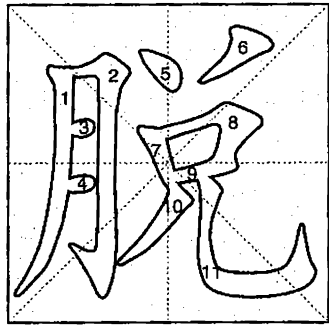

脱 tuō

1552

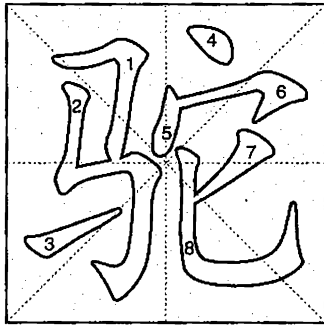

驼 tuó

1553

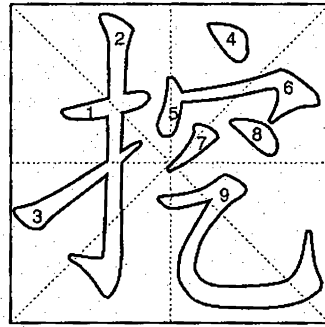

挖 wā

1554

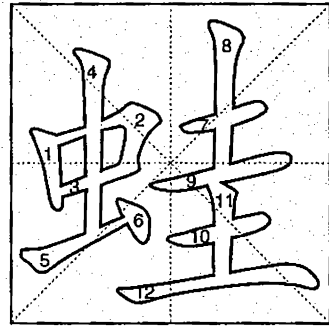

蛙 wā

1555

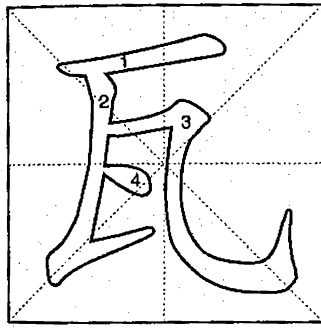

瓦 wǎ

1556

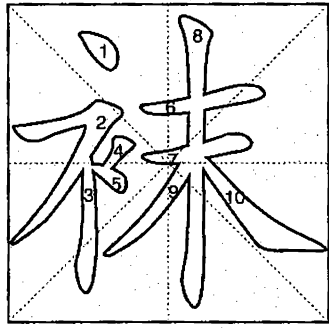

袜 wà

1557

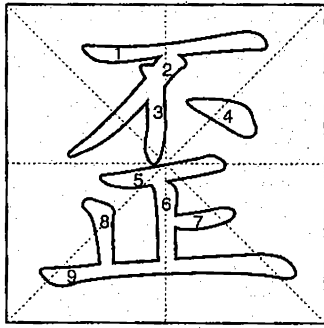

歪 wāi

1558

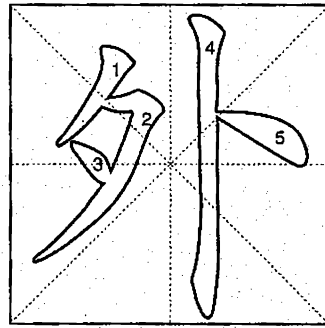

外 wài

1559

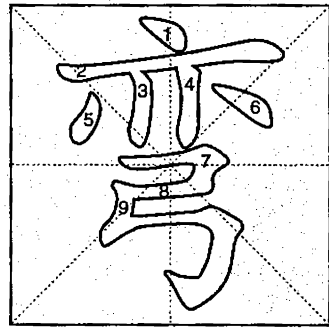

弯 wān

1560

### 拖 tuō

- ① pull; drag; haul  
② delay; drag on; procrastinate

拖布 tuō'bù  
mop  
拖拉机 tuō'lǎjī  
tractor  
拖欠 tuō'qiàn  
be in arrears; default

### 屯 tún

- ① collect; store up ② station (troops); quarter

屯兵 tún'bīng  
station troops  
屯粮 tún'liáng  
hoard up grains

### 吞 tūn

- ① swallow; gulp down  
② take possession of; annex

吞吐 tūn'tǔ  
swallow and spit  
吞吐量 tūn'tǔ'liàng  
handling capacity  
吞吞吐吐 tūn'tūn'tǔ'tǔ  
hesitate in speech

### 退 tuì

- ① move back; retreat ② cause to move back; remove ③ withdraw from; quit ④ decline; recede; ebb

退出 tuì'chū  
withdraw from; secede  
退还 tuì'huán  
return  
退休 tuì'xiū  
retire

### 腿 tuǐ

- ① leg ② a liglike support  
腿肚子 tuǐ'dù'zi  
calf (of the leg)  
腿脚 tuǐ'jiǎo  
legs and feet  
腿腕子 tuǐ'wǎn'zi  
ankle

### 蛙 wā

frog  
蛙人 wā'rén  
frogman  
蛙泳 wā'yǒng  
breaststroke

### 挖 wā

dig; excavate  
挖掉 wā'diào  
dig up  
挖苦 wā'kǔ  
ridicule; satirize  
挖土机 wā'tǔjī  
excavator

### 驼 tuó

① camel ② hunchbacked  
驼背 tuó'bèi  
hunchback  
驼峰 tuó'fēng  
hump  
驼色 tuó'sè  
light tan

### 脱 tuō

① (of hair, skin) shed; come off  
② take off; cast off ③ escape from;  
get out of ④ miss (out)  
脱发 tuō'fǎ  
loss of the hair; alopecia  
脱水 tuō'shuǐ  
dehydration  
脱险 tuō'xiǎn  
escape danger

### 托 tuō

① hold in the palm; support with the hand or palm ② sth. serving as a support ③ serve as a foil; set off  
托儿所 tuō'ér'suǒ  
nursery  
托福 tuō'fú  
thanks to you; TOEFL  
托收 tuō'shōu  
collection

### 弯 wān

① curved; tortuous; crooked  
② bend; flex ③ curve; bend  
弯道 wān'dào  
curve; bend; turn  
弯路 wān'lù  
crooked road  
弯曲 wān'qū  
winding; bent

### 外 wài

① outer; outward; outside ② other  
③ foreign; external ④ (relatives) of one's mother, sisters or daughters  
外币 wài'bì  
foreign currency  
外国 wài'guó  
foreign country  
外汇 wài'huì  
foreign exchange

### 歪 wāi

① askew; aslant; inclined;  
slanting ② devious; underhand  
歪理 wāi'lǐ  
erroneous reasoning  
歪门邪道 wāi'mén'xié'dào  
crooked ways  
歪曲 wāi'qū  
twist; distort

### 袜 wà

socks; stockings; hose  
袜子 wà'zi  
socks; stockings; hose

### 瓦 wǎ

cover (a roof) with tiles; tile  
瓦刀 wǎ'dāo  
(bricklayer's) cleaver

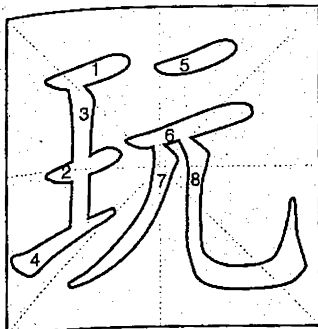

玩 wán 1561

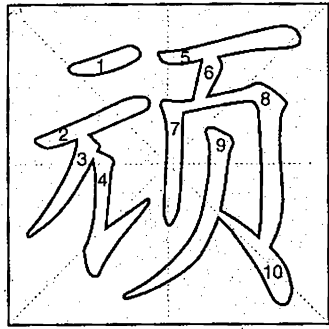

頑 wán 1562

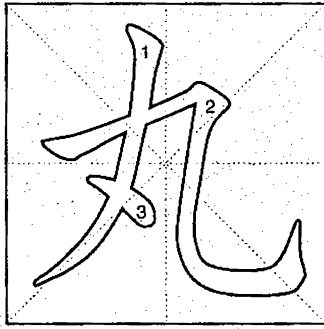

丸 wán 1563

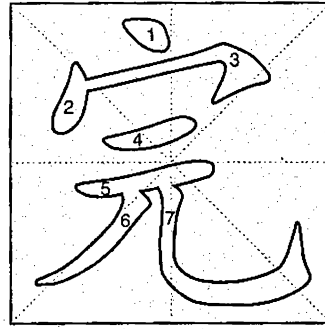

完 wán 1564

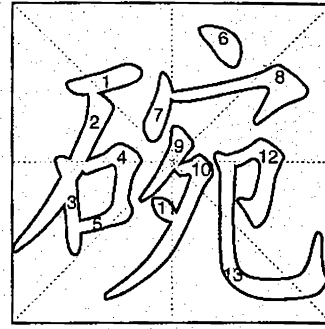

碗 wǎn 1565

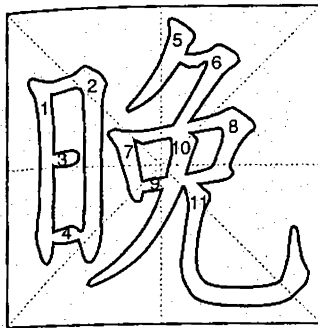

晚 wǎn 1566

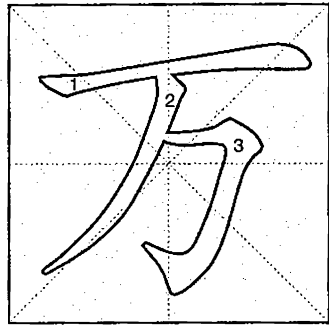

万 wàn 1567

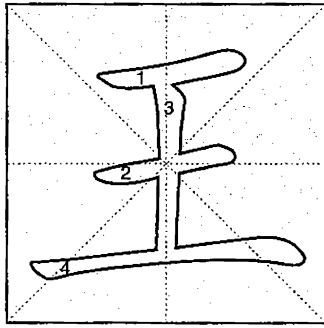

王 wáng 1568

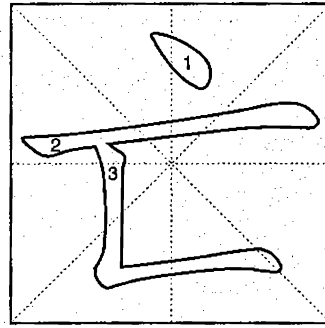

亡 wáng 1569

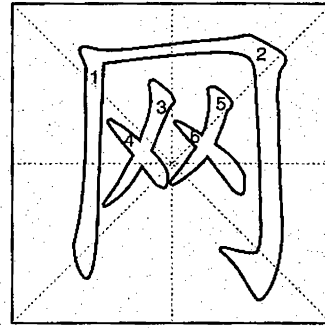

网 wǎng 1570

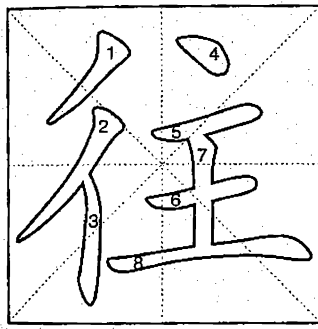

往 wǎng 1571

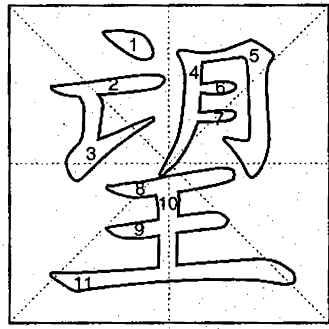

望 wàng 1572

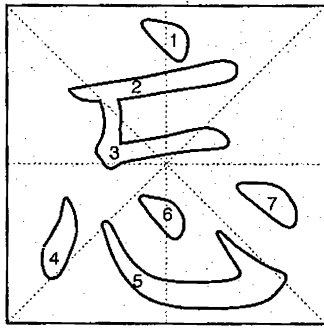

忘 wàng 1573

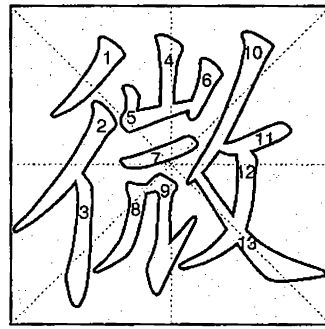

微 wēi 1574

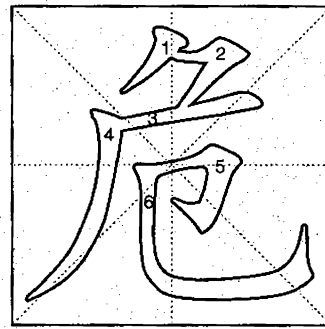

危 wēi 1575

### 碗 wǎn

bowl  
碗橱 wǎn'chú  
cupboard

### 完 wán

①intact; whole ②run out; use up  
③finish; complete; be over; be through ④pay (taxes)  
完成 wán'chéng  
accomplish; complete  
完婚 wán'hūn  
get married; marry  
完税 wán'shuì  
pay tax; pay duty

### 丸 wán

①ball; pellet ②pill; bolus  
丸药 wán'yào  
pill of Chinese medicine  
丸子 wán'zi  
ball; pill

### 顽 wán

①stupid; dense  
②stubborn; obstinate  
顽固 wán'gù  
stubborn; obstinate  
顽童 wán'tóng  
naughty child; urchin  
顽症 wán'zhèng  
persistent ailment

### 玩 wán

①play; have fun; amuse oneself  
②employ; resort to ③treat lightly  
④enjoy; appreciate  
玩火 wán'huǒ  
play with fire  
玩耍 wán'shuǎ  
play; have fun  
玩笑 wán'xiào  
joke

### 网 wǎng

①net ②network  
③catch with a net  
网吧 wǎng'bā  
cybercafe; Internet bar  
网络 wǎng'lù  
network; net  
网页 wǎng'yè  
web page

### 亡 wáng

①flee; run away ②lose; be gone  
③die; perish ④deceased  
⑤conquer; subjugate  
亡故 wáng'gù  
die; pass away; decess  
亡国 wáng'guó  
subjugate a nation  
亡灵 wáng'líng  
ghost

### 王 wáng

king; monarch  
王朝 wáng'cháo  
imperial court; dynasty  
王冠 wáng'guān  
imperial crown  
王国 wáng'guó  
kingdom; realm; domain

### 万 wàn

①ten thousand ②a very great number ③absolutely; by all means  
万分 wàn'fēn  
very much; extremely  
万国 wàn'guó  
all countries; the world  
万里长城 wàn'lǐ'chéng'chéng  
the Great Wall

### 晚 wǎn

①evening; night  
②far on in time; late  
晚安 wǎn'ān  
good night  
晚饭 wǎn'fàn  
supper; dinner  
晚会 wǎn'huì  
evening party

### 危 wēi

①danger; peril ②endanger; imperil  
危害 wēi'hài  
harm; endanger  
危机 wēi'jī  
crisis  
危险 wēi'xiǎn  
dangerous; perilous

### 微 wēi

①minute; tiny ②profound; abstruse ③decline  
微波炉 wēi'bō'lú  
microwave oven  
微风 wēi'fēng  
gentle breeze  
微小 wēi'xiǎo  
small; little

### 忘 wàng

①forget; dismiss from one's mind  
②overlook; neglect  
忘年交 wàng'nián'jiāo  
friendship between generations  
忘却 wàng'què  
forget  
忘我 wàng'wǒ  
selfless

### 望 wàng

①gaze into the distance; look over ②call on; visit ③hope; expect  
望远镜 wàng'yuǎn'jìng  
telescope  
望月(天) wàng'yuè(tiān)  
full moon  
望子成龙 wàng'zǐ'chéng'lóng  
long to see one's children have a bright future

### 往 wǎng

①go ②in the direction of; toward  
③past; previous  
往后 wǎng'hòu  
from now on  
往来 wǎng'lái  
come and go; contact  
往事 wǎng'shì  
past events; the past

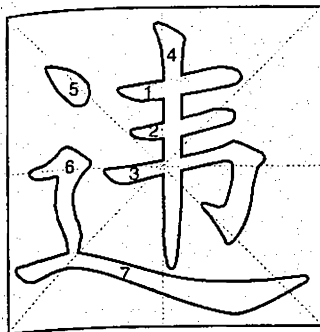

违 wéi 1576

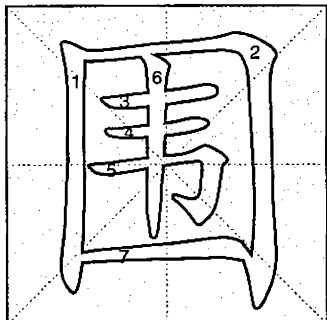

围 wéi 1577

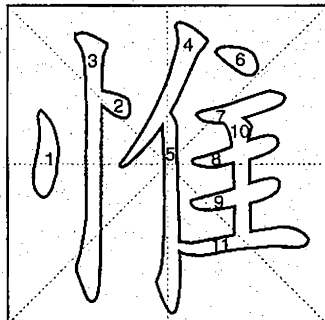

惟 wéi 1578

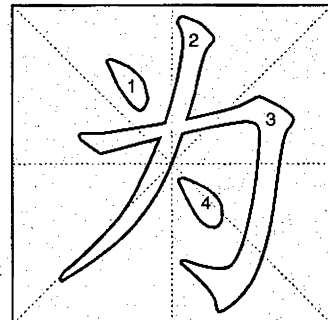

为 wéi 1579

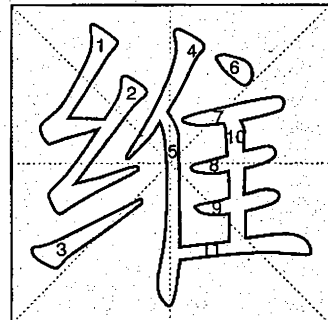

维 wéi 1580

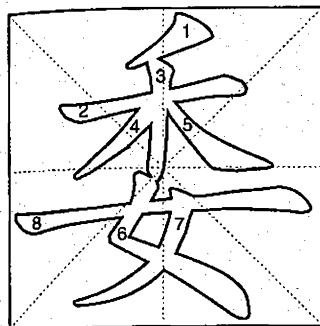

委 wěi 1581

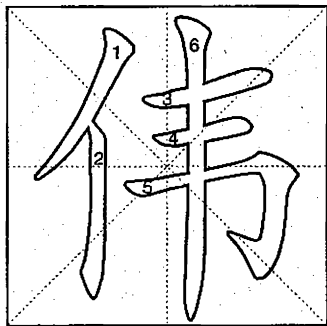

伟 wěi 1582

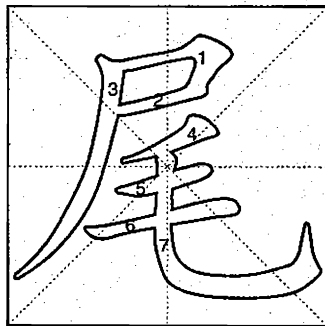

尾 wěi 1583

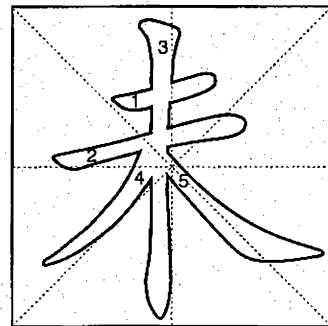

未 wèi 1584

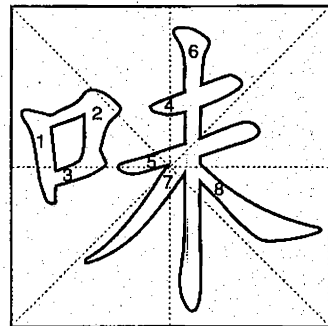

味 wèi 1585

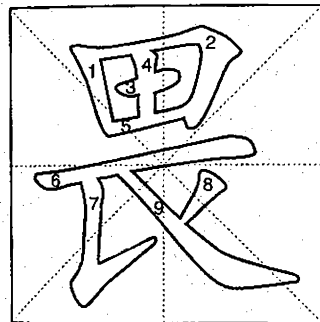

畏 wèi 1586

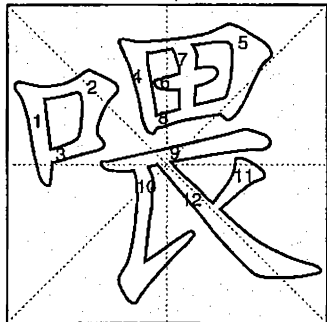

喂 wèi 1587

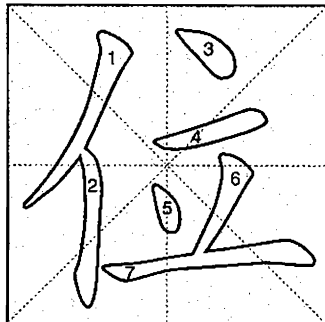

位 wèi 1588

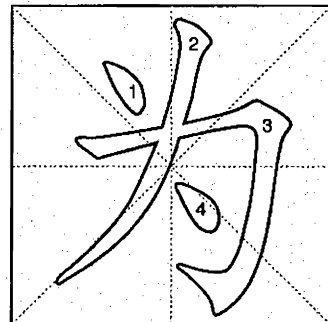

为 wèi 1589

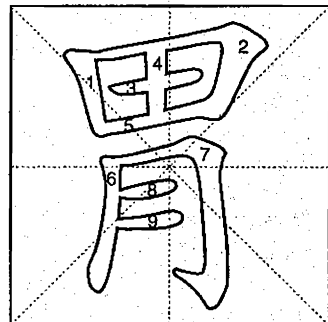

胃 wèi 1590



### 维 wéi

①tie up; hold together ②safe-guard; preserve; maintain; defend; uphold ③thinking; thought  
 维持 wéi'chí  
 keep; maintain; preserve  
 维和 wéi'hé  
 peacekeeping  
 维权 wéi'quán  
 safeguard legitimate rights and interests

### 为 wéi

①do; act ②act as; serve as ③become ④be; mean ⑤by  
 为人 wéi'rén  
 behave; conduct oneself  
 为首 wéi'shǒu  
 headed by  
 为止 wéi'zhǐ  
 up to; till

### 惟 wéi

①only; alone ②but  
 惟恐 wéi'kǒng  
 for fear that; lest  
 惟利是图 wéi'lì'shì'tú  
 put profit first  
 惟妙惟肖 wéi'miào'wéi'xiào  
 absolutely lifelike

### 围 wéi

①enclose; surround  
 ②all round; around  
 围观 wéi'guān  
 rubberneck  
 围巾 wéi'jīn  
 scarf  
 围裙 wéi'qún  
 apron

### 违 wéi

①disobey ②be separated  
 违背 wéi'bèi  
 violate; go against  
 违反 wéi'fǎn  
 violate  
 违约 wéi'yuē  
 break a contract

### 味 wèi

①taste; flavour  
 ②smell; odour ③interest  
 ④distinguish the flavour of  
 味道 wèi'dào  
 taste; flavour  
 味精 wèi'jīng  
 monosodium glutamate  
 味觉 wèi'jué  
 sense of taste

### 未 wèi

①have not; did not ②not  
 未成年 wèi'chéng'nián  
 under age  
 未婚 wèi'hūn  
 unmarried; single  
 未来 wèi'lái  
 coming; approaching

### 尾 wěi

①tail ②end ③remaining part; remnant  
 尾巴 wěi'ba  
 tail; tail-like part  
 尾气 wěi'qì  
 tail gas  
 尾追 wěi'zhuī  
 hot on the trail of

### 伟 wěi

big; great  
 伟大 wěi'dà  
 great; big; mighty  
 伟绩 wěi'jì  
 great feats  
 伟人 wěi'rén  
 a great man

### 委 wěi

①entrust; appoint  
 ②throw away; cast aside  
 ③shift  
 ④indirect; roundabout  
 委任 wěi'rèn  
 appoint; designate  
 委托 wěi'tuō  
 entrust; trust  
 委员 wěi'yuán  
 committee member

### 胃 wèi

stomach  
 胃镜 wèi'jìng  
 gastroscop  
 胃口 wèi'kǒu  
 appetite; liking  
 胃溃疡 wèi'kuì'yáng  
 gastric ulcer

### 为 wèi

①for ②for the sake of; in order to  
 为此 wèi'cǐ  
 for this reason  
 为何 wèi'hé  
 why; for what reason  
 为什么 wèi'shén'me  
 why

### 位 wèi

①place; location ②position  
 ③throne ④place; figure; digit  
 位于 wèi'yú  
 be located; be situated  
 位子 wèi'zi  
 seat; place

### 喂 wèi

①hello; hey ②feed  
 喂奶 wèi'nǎi  
 breast-feed; nurse  
 喂养 wèi'yǎng  
 feed; raise; keep

### 畏 wèi

①fear ②respect  
 畏惧 wèi'jù  
 fear; dread  
 畏难 wèi'nán  
 be afraid of difficulty  
 畏怯 wèi'qiè  
 cowardly; timid;  
 chicken-hearted

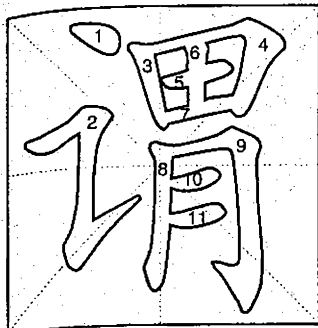

谓 wèi 1591



慰 wèi 1592

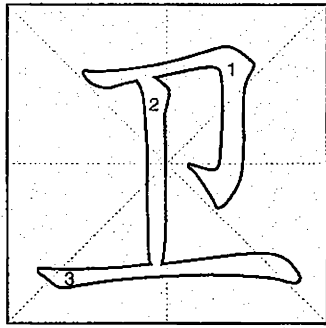

卫 wèi 1593

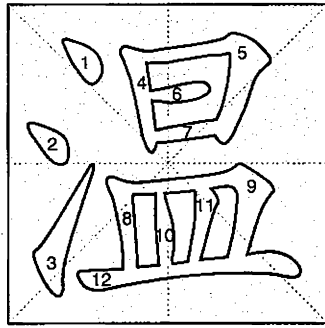

温 wēn 1594

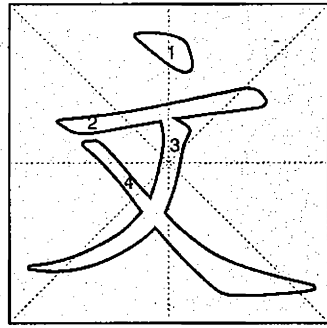

文 wén 1595

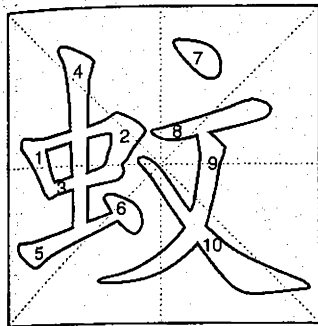

蚊 wén 1596

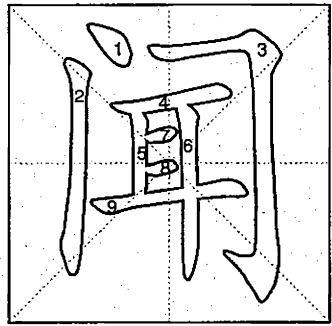

闻 wén 1597

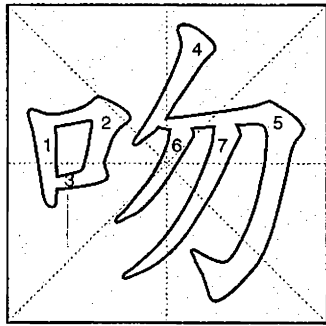

吻 wěn 1598

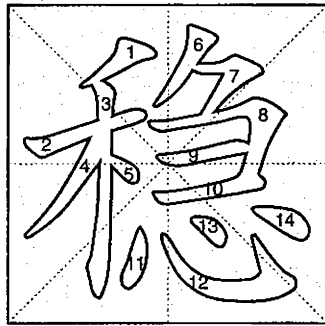

稳 wěn 1599

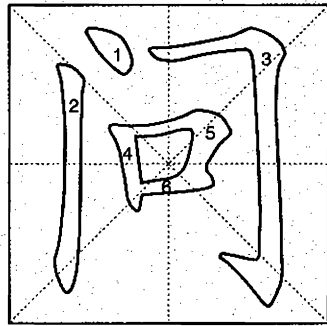

问 wèn 1600

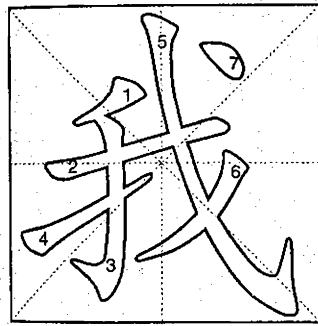

我 wǒ 1601

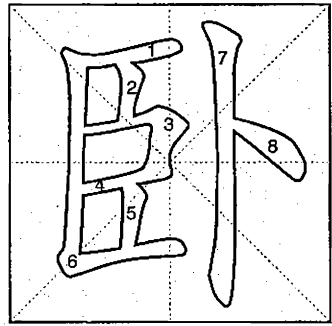

卧 wò 1602

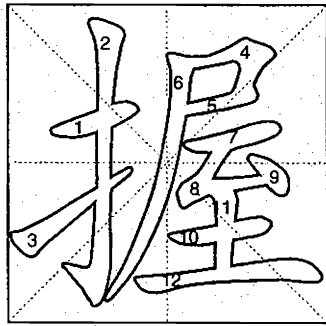

握 wò 1603

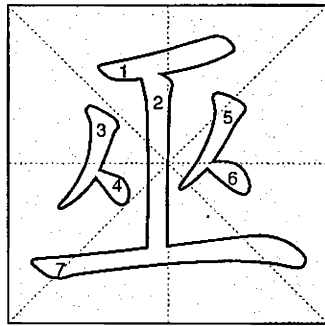

巫 wū 1604

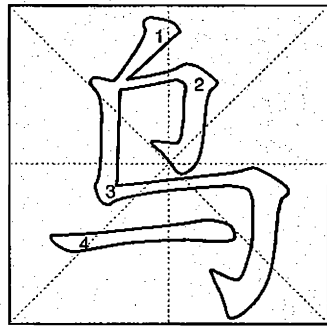

乌 wū 1605

### 文 wén

- ①character; script; writing  
 ②language ③literary composition  
 ④literary language ⑤culture.  
 文本 wén'běn  
 text; version  
 文火 wén'huǒ  
 slow fire  
 文学 wén'xué  
 literature

### 温 wēn

- ①warm ②temperature (of the body)  
 ③warm up ④review; revise  
 温饱 wēn'bǎo  
 the basic need  
 温差 wēn'chā  
 difference in temperature  
 温度 wēn'dù  
 temperature

### 卫 wèi

- ①defend; guard; protect  
 卫兵 wèi'bīng  
 guard; bodyguard  
 卫生纸 wèi'shēng'zhǐ  
 toilet paper; toilet roll  
 卫星 wèi'xīng  
 satellite

### 慰 wèi

- ①console; comfort ②be relieved  
 慰安妇 wèi'ān'fù  
 comfort woman  
 慰劳 wèi'láo  
 bring gifts and greetings to  
 慰问 wèi'wèn  
 convey best wishes to

### 谓 wèi

- ①say ②call; name  
 ③meaning; sense  
 谓语(语) wèi'yǔ(yǔ)  
 predicate

### 问 wèn

- ①ask; inquire ②inquire after  
 ③interrogate examine ④hold responsible  
 问答 wèn'dá  
 questions and answers  
 问世 wèn'shì  
 be published; come out  
 问讯 wèn'xùn  
 inquire; ask

### 稳 wěn

- ①steady; firm ②sure; certain  
 稳定 wěn'dìng  
 stable; steady  
 稳健派 wěn'jiàn'pài  
 moderates  
 稳重 wěn'zhòng  
 steady; staid; sedate

### 吻 wěn

- ①lips ②kiss ③an animal's mouth  
 吻合 wěn'hé  
 be identical; coincide; tally

### 闻 wén

- ①hear ②news; story ③famous  
 ④reputation ⑤smell  
 闻风而动 wén'fēng'ér'dòng  
 go into action without delay  
 闻名 wén'míng  
 well-known; famous  
 闻所未闻 wén'suǒ'wèi'wén  
 never heard of

### 蚊 wén

- mosquito  
 蚊虫 wén'chóng  
 mosquito  
 蚊香 wén'xiāng  
 mosquito-repellent incense  
 蚊子 wén'zi  
 mosquito

### 乌 wū

- ①crow ②black; dark  
 乌龟 wū'guī  
 tortoise  
 乌金 wū'jīn  
 coal  
 乌托邦 wū'tuō'bāng  
 Utopia

### 巫 wū

- shaman; witch  
 巫婆 wū'pó  
 witch; sorceress  
 巫师 wū'shī  
 wizard; sorcerer  
 巫医 wū'yī  
 witch doctor

### 握 wò

- hold; grasp  
 握力 wò'lì  
 grip  
 握拳 wò'quán  
 make a fist  
 握手 wò'shǒu  
 shake hands

### 卧 wò

- ①lie ②for sleeping in  
 卧车 wò'chē  
 sleeping car  
 卧床 wò'chuáng  
 lie in bed  
 卧室 wò'shì  
 bedroom

### 我 wǒ

- ①I ②we  
 我们 wǒ'men  
 we  
 我们自己 wǒ'men'zì'jǐ  
 ourselves  
 我自己 wǒ'zì'jǐ  
 myself

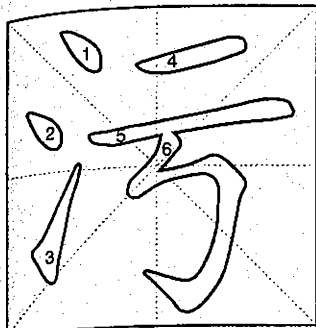

污 wū 1606

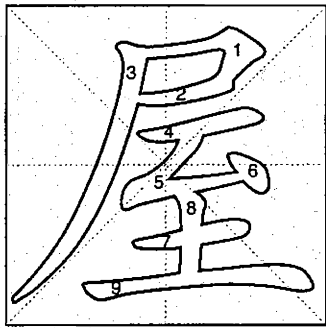

屋 wū 1607

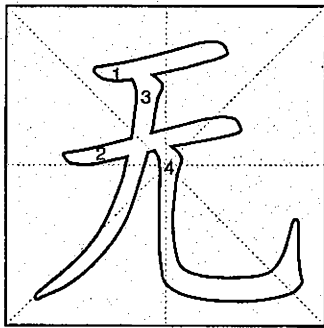

无 wú 1608

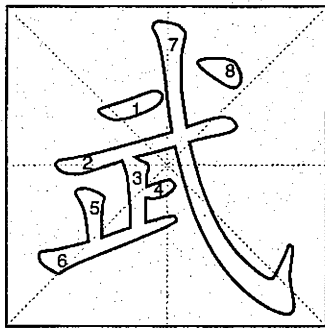

武 wǔ 1609

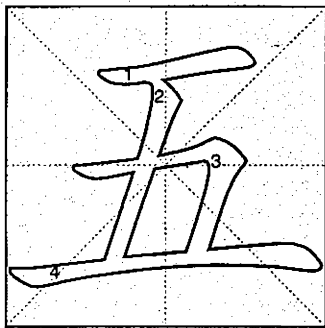

五 wǔ 1610

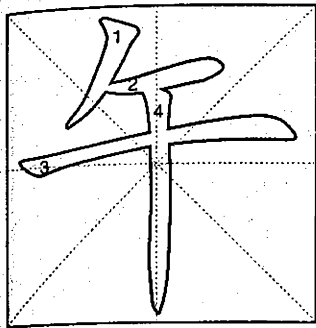

午 wǔ 1611

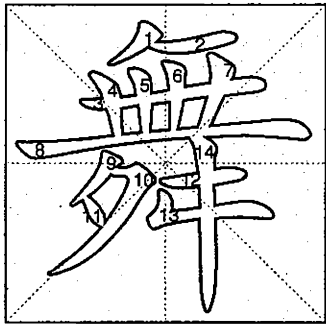

舞 wǔ 1612

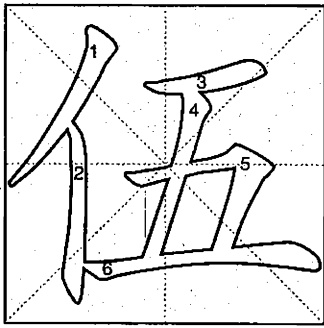

伍 wǔ 1613

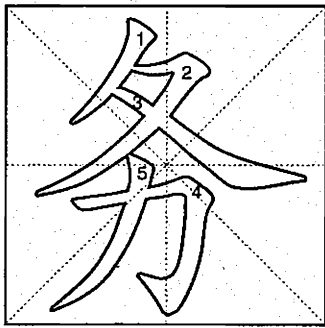

务 wù 1614

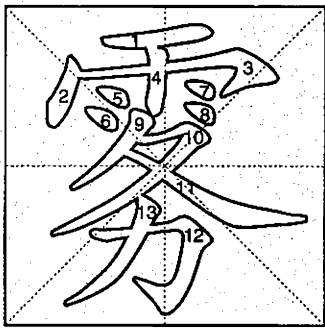

雾 wù 1615

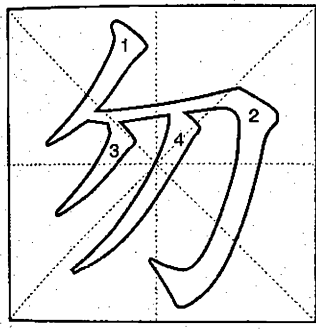

勿 wù 1616

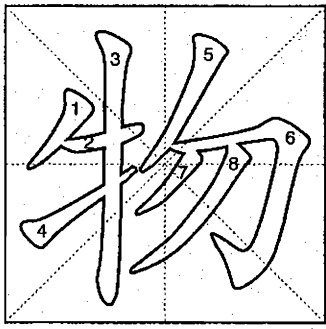

物 wù 1617

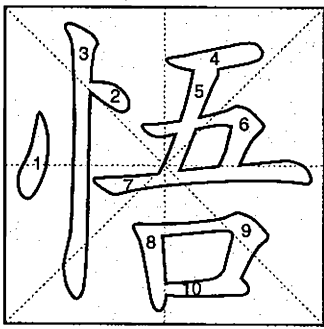

悟 wù 1618

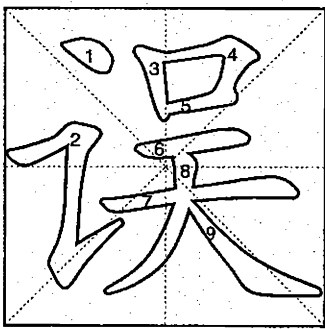

误 wù 1619

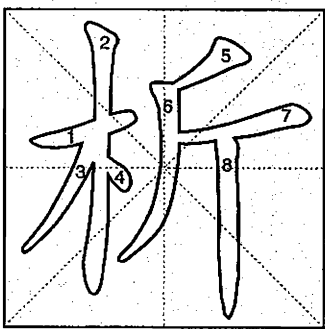

析 xī 1620

### 五 wǔ

five  
五角大楼 wǔ'jiǎo'dà'lóu  
the Pentagon  
五金 wǔ'jīn  
hardware  
五月 wǔ'yuè  
May

### 武 wǔ

① military ② valiant  
武力 wǔ' lì  
force; military force  
武侠 wǔ'xiá  
swordsman  
武装冲突 wǔ'zhuāng'chōng'tū  
armed conflict

### 无 wú

① nothing; nil ② not have; ③ not  
④ regardless of; no matter whether,  
what, etc.  
无尘 wú'chén  
dust free  
无花果 wú'huā'guǒ  
fig  
无价之宝 wú'jià'zhī'bǎo  
priceless treasure

### 屋 wū

① house ② room  
屋顶 wū'dǐng  
roof; housetop  
屋顶平台 wū'dǐng'píng'tái  
terrace  
屋子 wū'zi  
room

### 污 wū

① dirt; filth ② dirty; filthy; foul  
③ corrupt (officials) ④ defile; smear  
污点 wū'diǎn  
spot; stain; smirch  
污泥 wū'ní  
mud; mire; sludge  
污水 wū'shuǐ  
polluted water

### 雾 wù

① fog ② fine spray  
雾灯 wù'dēng  
foglamp  
雾化 wù'huà  
atomize; atomization  
雾气 wù'qì  
fog; mist; vapor

### 务 wù

① affair; business ② be engaged in;  
devote one's efforts to  
务必 wù'bì  
must  
务工 wù'gōng  
be a worker  
务实 wù'shí  
be pragmatic

### 伍 wǔ

① five ② army ③ company  
队伍 duì'wǔ  
troops; ranks

### 舞 wǔ

① dance  
② flourish; wield; brandish; wave  
舞伴 wǔ'bàn  
dancing partner  
舞场 wǔ'chǎng  
dance hall; ballroom  
舞台 wǔ'tái  
stage

### 午 wǔ

noon  
午餐 wǔ'cān  
lunch  
午休 wǔ'xiū  
noon break  
午夜 wǔ'yè  
midnight

### 析 xī

① divide; separate ② analyse;  
dissect the meaning (of a word, etc.)  
析疑 xī'yí  
resolve a doubt  
析义 xī'yì  
analyse the meaning

### 误 wù

① mistake; error ② miss ③ harm  
④ by mistake; by accident  
误导 wù'dǎo  
misguide  
误会 wù'huì  
misunderstand  
误诊 wù'zhěn  
make a wrong diagnosis

### 悟 wù

realize; awaken  
悟性 wù'xìng  
comprehension

### 物 wù

① thing; matter ② content;  
substance  
物价 wù'jià  
prices  
物理 wù'lǐ  
physics  
物品 wù'pǐn  
article; goods

### 勿 wù

no; not

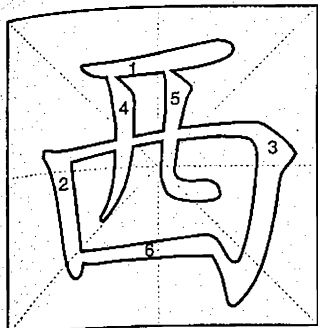

西 xī 1621

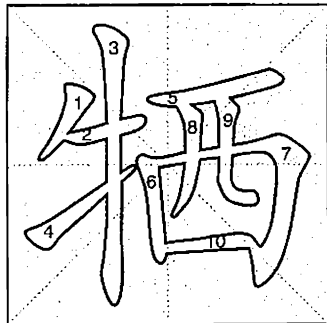

栖 qī 1622

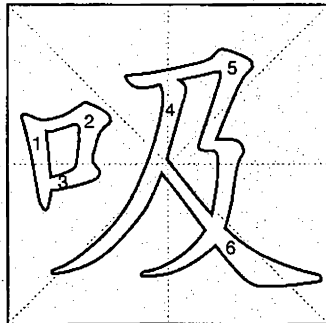

吸 xī 1623



希 xī 1624

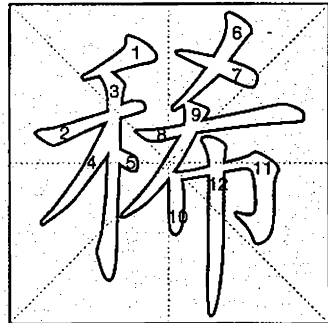

稀 xī 1625

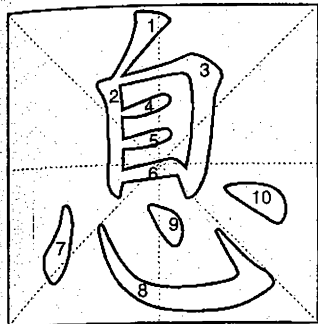

息 xī 1626

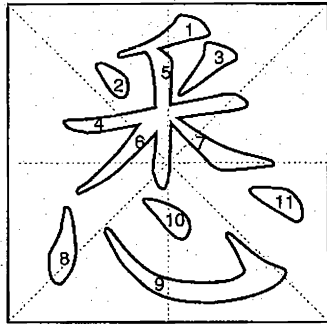

悉 xī 1627

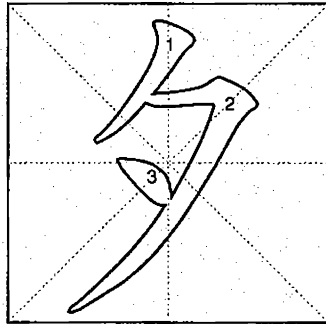

夕 xī 1628

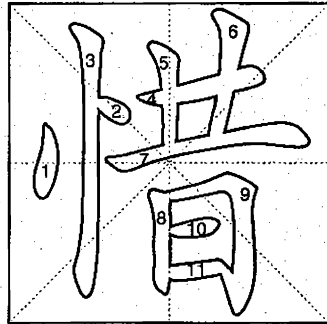

惜 xī 1629

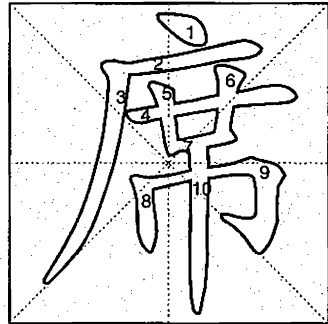

席 xí 1630

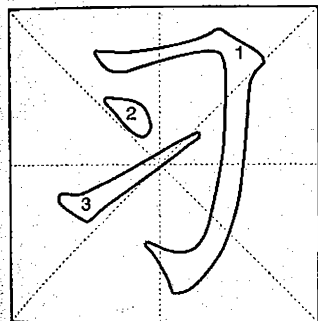

习 xí 1631

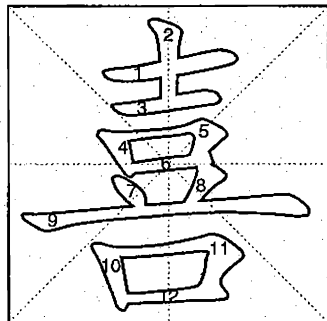

喜 xǐ 1632

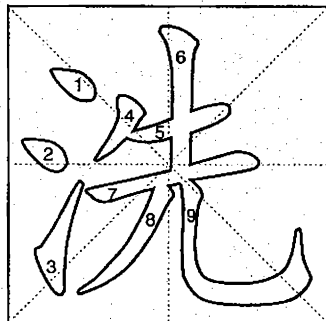

洗 xǐ 1633

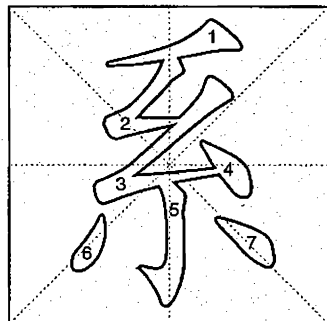

系 xì 1634

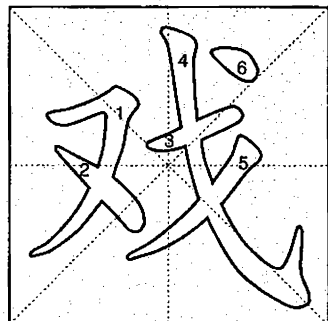

戏 xì 1635

### 稀 xī

- ①rare; scarce; uncommon  
②sparse; scattered  
③watery; thin

稀饭 xī fàn

rice or millet gruel

稀客 xī kè

rare visitor

稀有 xī yǒu

rare

### 希 xī

- ①hope ②rare; scarce

希奇古怪 xī 'qí' gǔ 'gài

rare and peculiar

希世 xī shì

rare

希望 xī wàng

prospect; hope; wish

### 吸 xī

①inhale; breathe in; draw

②absorb; suck up

③attract; draw to oneself

吸尘器 xī chén 'qì

vacuum-cleaner

吸毒 xī dú

take drugs

吸烟 xī yān

smoke

### 牺 xī

sacrifice

牺牲 xī shēng

sacrifice

牺牲品 xī shēng 'pǐn

victim; prey

### 西 xī

- ①west ②Occidental; Western

西瓜 xī 'guā

watermelon

西红柿 xī hóng 'shì

tomato

西门子(电) xī mén 'zì (diàn)

siemens

### 席 xí

- ①mat ②seat; place ③feast; banquet

席地 xī dì

on the ground

席卷 xī juǎn

carry everything with one

席位 xī wèi

seat

### 惜 xī

- ①cherish; value highly; care for tenderly ②spare; grudge; stint; have pity on sb.; feel sorry for sb.

惜别 xī bié

be reluctant to part

惜力 xī lì

not do one's best

### 夕 xī

- ①sunset ②evening; night

夕阳 xī yáng

the setting sun

夕照 xī zhào

evening glow

### 悉 xī

- ①all; entirely ②know; learn

悉心 xī xīn

take the utmost care

### 息 xī

- ①breath ②news ③cease; stop ④rest ⑤interest

息怒 xī nù

calm one's anger

息票 xī piào

interest coupons

息息相关 xī xī xiāng 'guān

be closely linked

### 戏 xì

- ①play; sport ②make fun of; joke ③drama; play; show

戏剧 xì jù

drama; play; theatre

戏目 xì mù

theatrical programme

戏曲 xì qǔ

traditional opera

### 系 xì

- ①system; series ②department (in a college); faculty ③tie; fasten ④feel anxious; be concerned

系列 xì liè

set; series

系统 xì tǒng

system

系主任 xì zhǔ 'rèn

dean

### 洗 xǐ

- ①wash; bathe ②baptize ③redress; right ④kill and loot ⑤develop (a film) ⑥shuffle (cards, etc.)

洗礼 xǐ lǐ

baptism

洗手间 xǐ shǒu 'jiān

toilet

洗澡 xǐ zǎo

take a bath

### 喜 xǐ

- ①happy; delighted; pleased ②happy event (esp. wedding); occasion for celebration ③pregnancy

④like

喜欢 xǐ huān

like; love; be fond of

喜剧 xǐ jù

comedy

喜讯 xǐ xùn

happy news; good news

### 习 xí

- ①practise; exercise ②get accustomed to; be used to ③habit; custom; usual practice

习惯 xí guān

habit; custom

习语 xí yǔ

idiom

习字 xí zì

practise penmanship

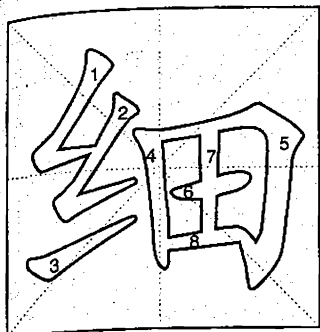

细 xì 1636

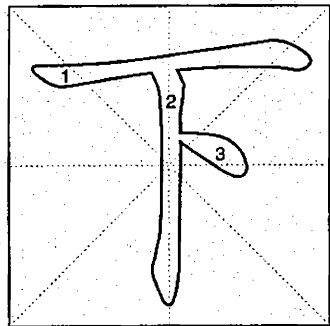

下 xià 1637

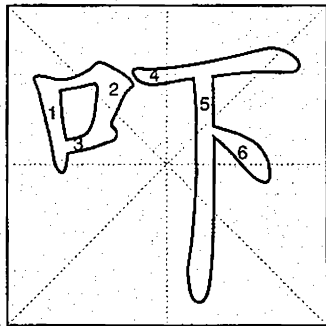

吓 xià 1638

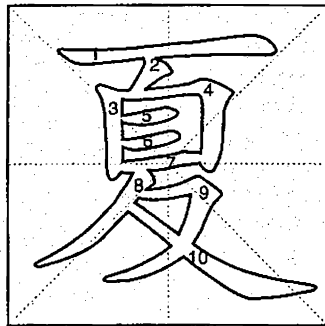

夏 xià 1639

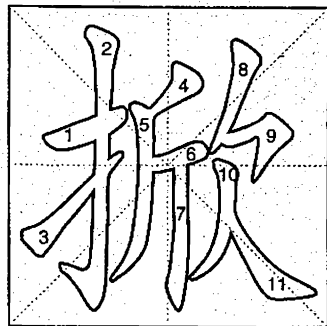

掀 xiān 1640

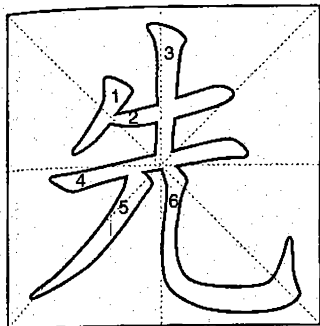

先 xiān 1641

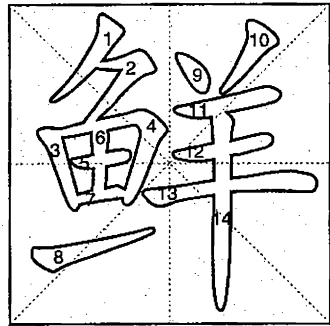

鲜 xiān 1642

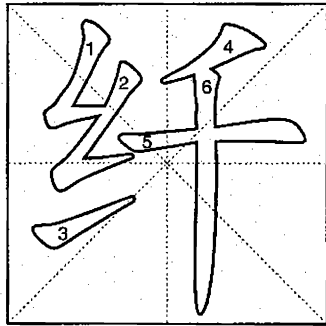

纤 xiān 1643

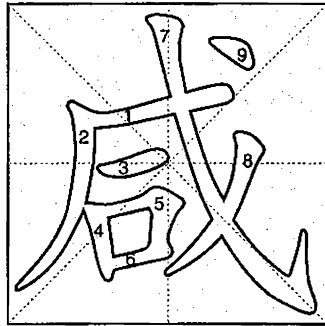

咸 xián 1644

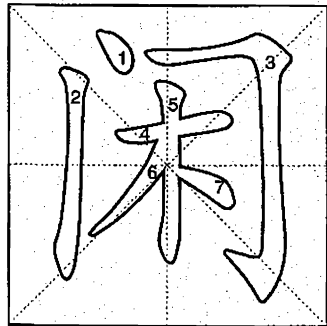

闲 xián 1645

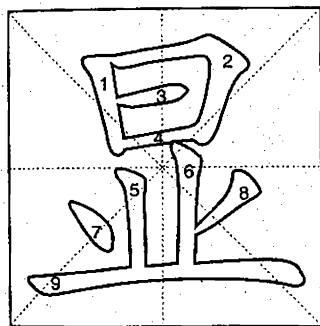

显 xiǎn 1646

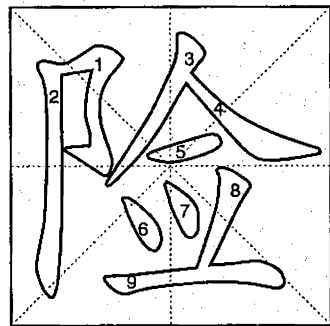

险 xiǎn 1647

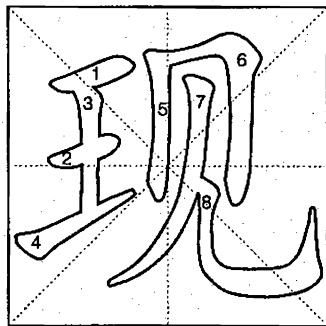

现 xiàn 1648

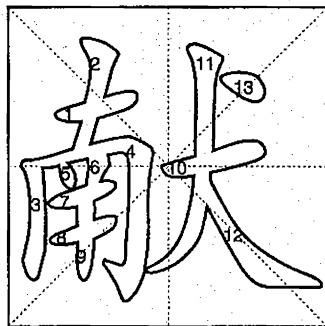

献 xiàn 1649

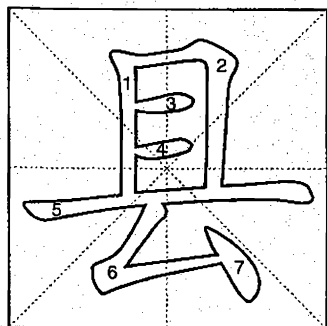

县 xiàn 1650



**掀 xiān**

lift (a cover, etc.)  
掀动 xiān'dòng  
lift; start; set in motion  
掀起 xiān'qǐ  
lift; raise; cause to surge

**夏 xià**

summer  
夏季 xià'jì  
summer  
夏令时 xià'lìng'shí  
summer time  
夏收 xià'shōu  
summer harvest

**吓 xià**

frighten; scare; intimidate  
吓唬 xià'hu  
frighten; scare  
吓坏 xià'huài  
terrify  
吓人 xià'rén  
terrible

**下 xià**

① below; down; under ② lower; inferior ③ next; latter ④ downward; down ⑤ descend; get off ⑥ (of rain, snow, etc.) fall  
下班 xià'bān  
off duty; knock off  
下次 xià'cì  
next time  
下令 xià'lìng  
give orders

**细 xì**

① thin; slender ② in small particles; fin ③ thin and soft ④ exquisite; delicate ⑤ meticulous; detailed  
细胞 xì'bāo  
cell  
细声细气 xì'shēng'xì'qì  
in a soft voice  
细心 xì'xīn  
careful; attentive

**闲 xián**

① not busy; idle ② not in use; unoccupied; idle ③ spare time; leisure  
闲空 xián'kòng  
free time; spare time  
闲书 xián'shū  
light reading  
闲谈 xián'tán  
engage in chitchat

**咸 xián**

salted; salty  
咸菜 xián'cài  
salted vegetables  
咸水 xián'shuǐ  
salt water  
咸盐 xián'yán  
salt

**纤 xiān**

fine; minute  
纤巧 xiān'qiǎo  
dainty; delicate  
纤维 xiān'wéi  
fibre  
纤小 xiān'xiǎo  
fine; tenuous

**鲜 xiān**

① fresh ② bright-coloured; bright ③ delicious; tasty ④ delicacy ⑤ aquatic foods  
鲜果 xiān'guǒ  
fresh fruit  
鲜明 xiān'míng  
bright; clear-cut  
鲜血 xiān'xuè  
blood

**先 xiān**

① earlier; before; first; in advance ② elder generation; ancestor; deceased; late  
先辈 xiān'bèi  
elder generation  
先发制人 xiān'fā'zhì'rén  
forestall the enemy  
先生 xiān'shēng  
teacher; mister (Mr.)

**县 xiàn**

county  
县城 xiàn'chéng  
county town  
县长 xiàn'zhǎng  
county magistrate

**献 xiàn**

① offer; present; dedicate; donate ② show; put on; display  
献礼 xiàn'lǐ  
present a gift  
献身 xiàn'shēn  
devote oneself to  
献血 xiàn'xiě  
donate blood

**现 xiàn**

① present; current ② (do sth.) in time of need ③ (of money) on hand ④ cash; ready money  
现代 xiàn'dài  
modern times  
现汇 xiàn'huì  
spot exchange  
现价 xiàn'jià  
present price

**险 xiǎn**

① a place difficult of access; narrow pass ② danger; peril; risk ③ vicious; venomous  
险关 xiǎn'guān  
narrow pass  
险境 xiǎn'jìng  
dangerous situation  
险阻 xiǎn'zǔ  
dangerous and difficult

**显 xiǎn**

① apparent; obvious ② show; display; manifest  
显而易见 xiǎn'ér'yì'jiàn  
obviously; clearly  
显示器 xiǎn'shì'qì  
monitor  
显像管 xiǎn'xiàng'guǎn  
kinescope

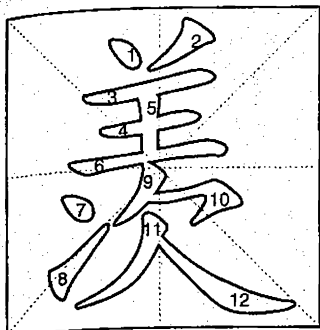

羡 xiàn 1651

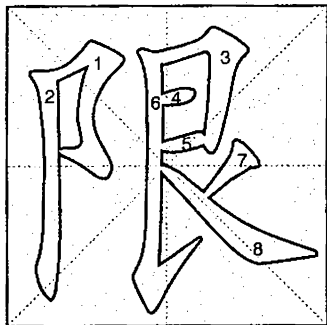

限 xiàn 1652

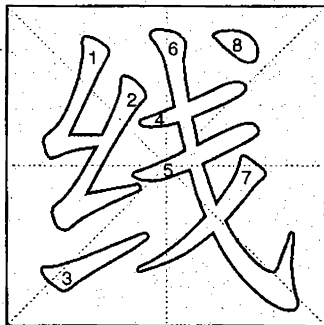

线 xiàn 1653

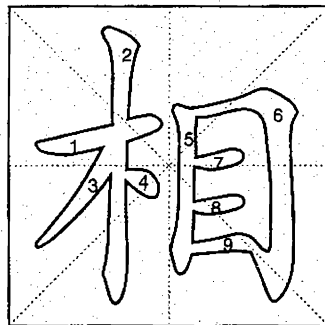

相 xiāng 1654

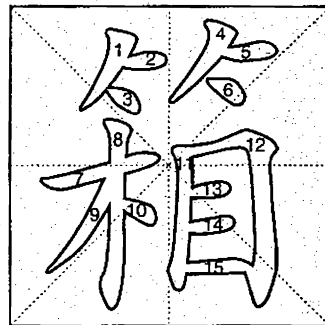

箱 xiāng 1655

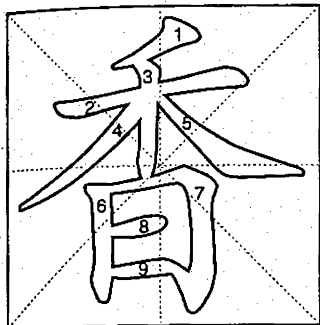

香 xiāng 1656

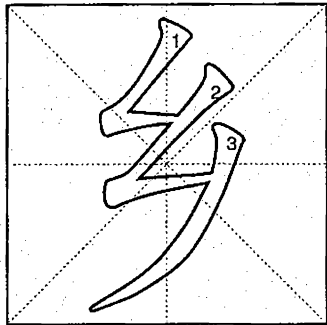

乡 xiāng 1657

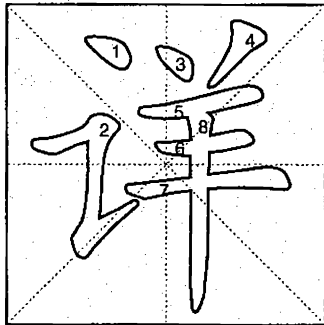

详 xiáng 1658

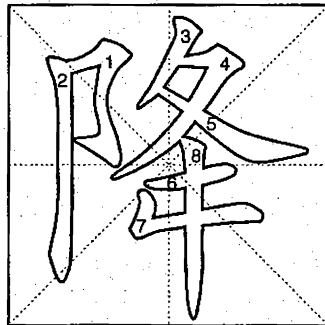

降 xiáng 1659

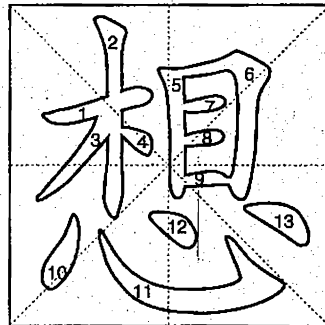

想 xiǎng 1660

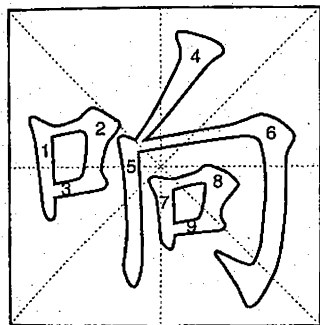

响 xiǎng 1661

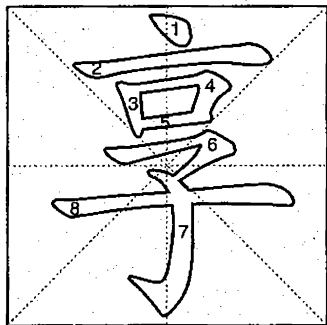

享 xiǎng 1662

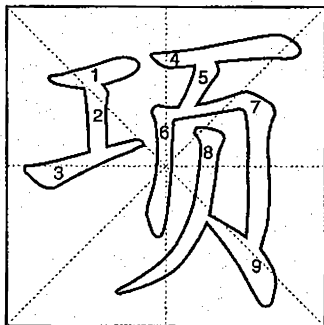

项 xiàng 1663

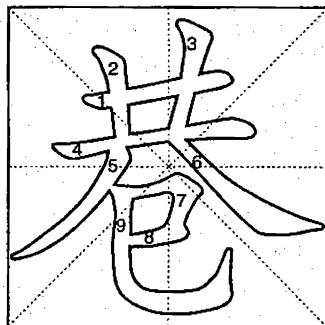

巷 xiàng 1664

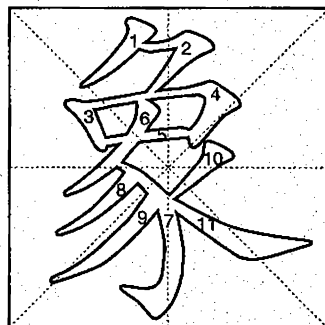

象 xiàng 1665

**箱 xiāng**

chest; box; case; trunk  
箱子 xiāng'zi  
chest; box; case; trunk

**相 xiāng**

each other; one another; mutually  
相爱 xiāng'ài  
love each other  
相等 xiāng'děng  
be equal  
相信 xiāng'xìn  
trust; believe in

**线 xiàn**

①thread; string; wire ②made of cotton thread ③line; route ④brink; verge  
线路 xiàn'lù  
line; circuit  
线条 xiàn'tiáo  
line; figure  
线装 xiàn'zhuāng  
thread binding

**限 xiàn**

①limit; bounds  
②set a limit; restrict  
限度 xiàn'dù  
limit; limitation  
限价 xiàn'jià  
the fixed price  
限期 xiàn'qī  
time limit; deadline

**羨 xiàn**

admire  
羡慕 xiàn'mù  
admire; envy

**想 xiǎng**

①think ②suppose; reckon; consider ③want to; would like to ④remember with longing; miss  
想不到 xiǎng'bu'dào  
unexpected  
想法 xiǎng'fǎ  
idea; opinion  
想念 xiǎng'niàn  
miss; long to see again

**降 xiáng**

surrender; capitulate  
降伏 xiáng'fú  
subdue; vanquish  
降服 xiáng'fú  
yield; surrender

**详 xiáng**

①detailed; minute ②details; particulars ③know clearly  
详尽 xiáng'jìn  
detailed; exhaustive  
详谈 xiáng'tán  
speak in detail  
详图 xiáng'tú  
detail (drawing)

**乡 xiāng**

①country; village; rural area  
②native place; home village or town  
③township

**香 xiāng**

①sweet-smelling; aromatic; scented ②savory; appetizing ③with good appetite ④perfume; spice  
香槟酒 xiāng'bīn'jiǔ  
champagne  
香蕉 xiāng'jiāo  
banana  
香水 xiāng'shuǐ  
perfume

**象 xiàng**

①elephant ②appearance; shape; image ③resemble ④look as if; seem ⑤such as; like  
象牙 xiàng'yá  
elephant's tusk; ivory  
象样 xiàng'yàng  
up to the mark  
象征 xiàng'zhēng  
symbolize; signify

**巷 xiàng**

lane; alley  
巷战 xiàng'zhàn  
street fighting  
巷子 xiàng'zi  
lane; alley

**项 xiàng**

①nape (of the neck) ②sum (of money) ③term  
项链 xiàng'liàn  
necklace  
项目 xiàng'mù  
item  
项圈 xiàng'quān  
necklace

**享 xiǎng**

enjoy  
享福 xiǎng'fú  
enjoy a happy life  
享年 xiǎng'nián  
die at the age of  
享有 xiǎng'yǒu  
enjoy (rights, etc.)

**响 xiǎng**

①sound; noise ②make a sound; ring ③noisy; loud ④echo  
响亮 xiǎng'liàng  
loud and clear  
响尾蛇 xiǎng'wěi'shé  
rattlesnake  
响应 xiǎng'yīng  
respond; answer

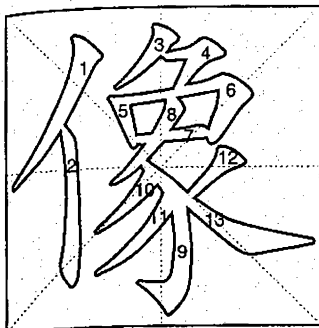

像 xiàng

1666

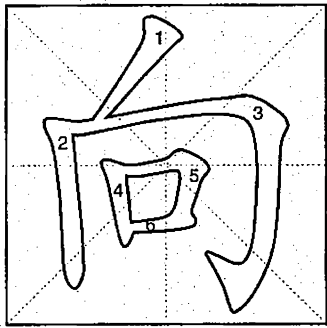

向 xiàng

1667

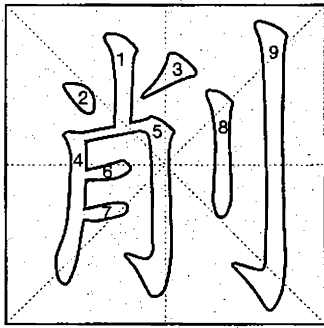

削 xiāo

1668

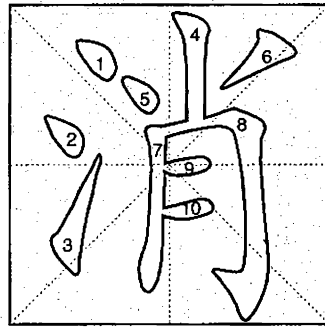

消 xiāo

1669

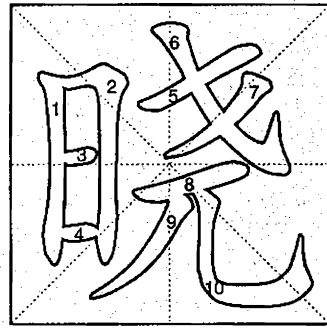

晓 xiǎo

1670

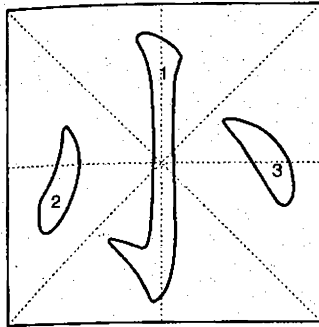

小 xiǎo

1671

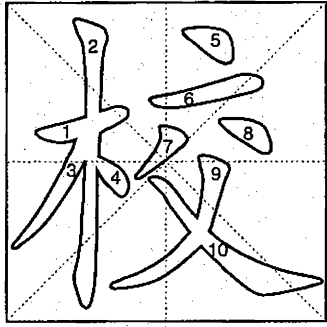

校 xiào

1672

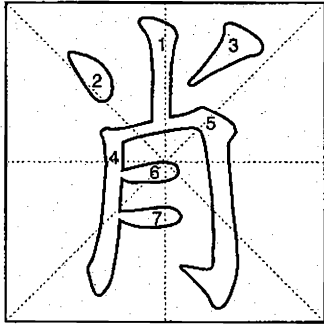

肖 xiào

1673

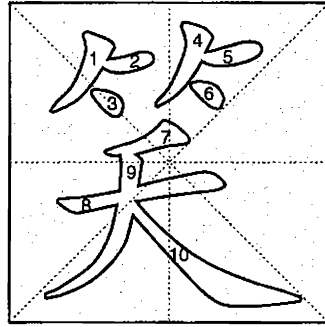

笑 xiào

1674

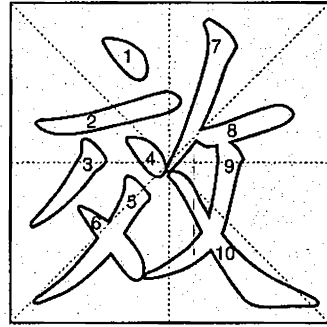

效 xiào

1675

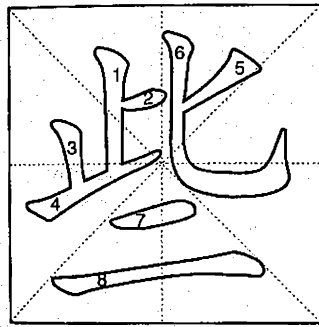

些 xiē

1676

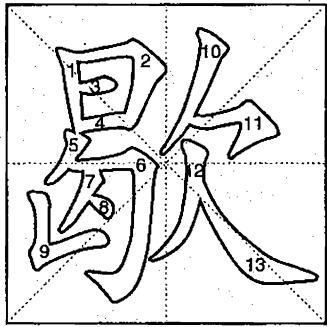

歇 xiē

1677

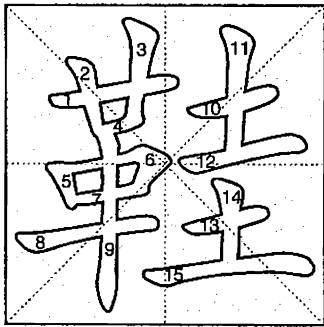

鞋 xié

1678

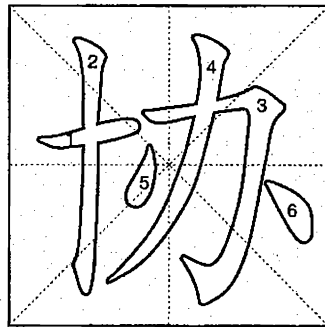

协 xié

1679

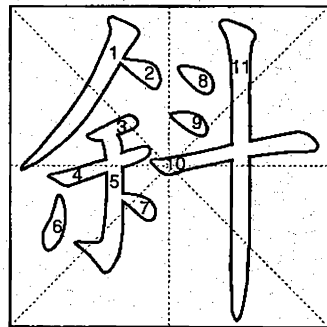

斜 xié

1680

### 晓 xiǎo

①dawn; daybreak ②know ③let sb. know; tell  
 晓得 xiǎo'de  
 know  
 晓示 xiǎo'shì  
 tell explicitly; notify

### 消 xiāo

①disappear; vanish  
 ②eliminate; dispel; remove  
 ③while away (the time)  
 消防 xiāo'fáng  
 fire fighting  
 消费 xiāo'fèi  
 consume  
 消气 xiāo'qì  
 cool down; be mollified

### 削 xiāo

pare with a knife  
 削皮 xiāo'pí  
 peel  
 削铅笔 xiāo'qiān'bǐ  
 sharpen a pencil  
 削球(乒乓) xiāo'qiú(pīng'pāng)  
 cut; chop

### 向 xiàng

①direction ②face; turn towards  
 ③take sb.'s part; be partial to  
 ④to; from  
 向导 xiàng'dǎo  
 guide  
 向日葵 xiàng'rì'kuí  
 sunflower  
 向往 xiàng'wǎng  
 look forward to

### 像 xiàng

①likeness (of sb.); portrait; picture ②image  
 像框 xiàng'kuàng  
 frame  
 像样 xiàng'yàng  
 up to the mark  
 像章 xiàng'zhāng  
 badge

### 效 xiào

①effect ②imitate ③devote (one's energy or life) to; render (a service)  
 效劳 xiào'láo  
 work for  
 效率 xiào'lǜ  
 efficiency  
 效益 xiào'yì  
 beneficial result

### 笑 xiào

①smile; laugh; grin ②ridicule  
 笑话 xiào'huà  
 joke; jest; laugh at  
 笑脸 xiào'liǎn  
 smiling face  
 笑容 xiào'róng  
 smiling expression

### 肖 xiào

resemble; be like  
 肖像 xiào'xiàng  
 portrait; portraiture

### 校 xiào

①school ②field officer  
 校车 xiào'chē  
 school bus  
 校风 xiào'fēng  
 school spirit  
 校庆 xiào'qìng  
 anniversary of the founding of a school or college

### 小 xiǎo

①small; little; petty ②for a short time ③young  
 小便池 xiǎo'biàn'chí  
 urinal  
 小吃 xiǎo'chī  
 snack  
 小丑 xiǎo'chǒu  
 clown; buffoon

### 斜 xié

oblique; slanting; incline; tilted  
 斜坡 xié'pō  
 slope  
 斜体字 xié'tǐ'zì  
 italics  
 斜面 xié'miàn  
 slant

### 协 xié

①joint; common ②assist  
 协定 xié'dìng  
 agreement; accord  
 协奏曲 xié'zòu'qǔ  
 concerto  
 协作 xié'zuò  
 cooperation

### 鞋 xié

shoes  
 鞋匠 xié'jiàng  
 shoemaker  
 鞋刷 xié'shuā  
 shoe brush  
 鞋油 xié'yóu  
 shoe polish

### 歇 xiē

①have a rest ②stop (work, etc.)  
 歇班 xiē'bān  
 be off duty  
 歇工 xiē'gōng  
 stop work  
 歇业 xiē'yè  
 close a business

### 些 xiē

some; few  
 些微 xiē'wēi  
 slightly; a little; a bit  
 些许 xiē'xǔ  
 a few; a little

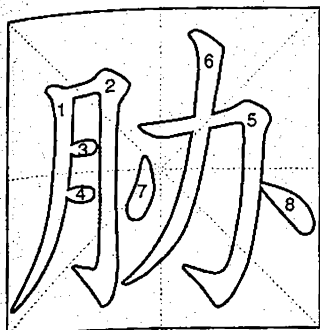

胁 xié 1681

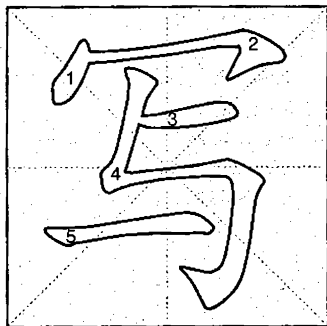

写 xiě 1682



械 xiè 1683

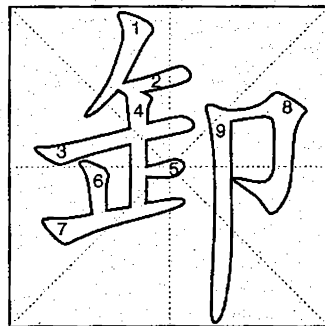

卸 xiè 1684

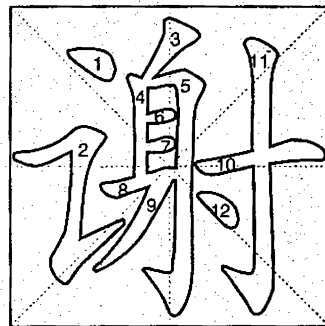

谢 xiè 1685

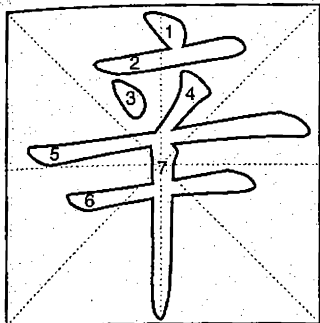

辛 xīn 1686

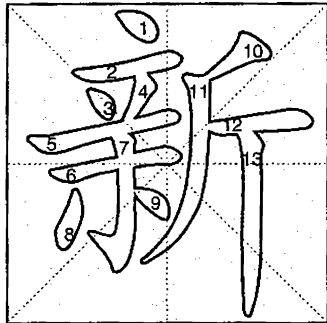

新 xīn 1687

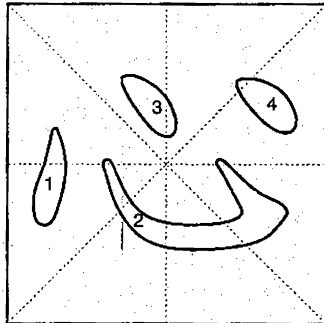

心 xīn 1688

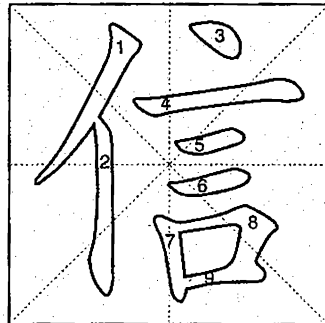

信 xìn 1689

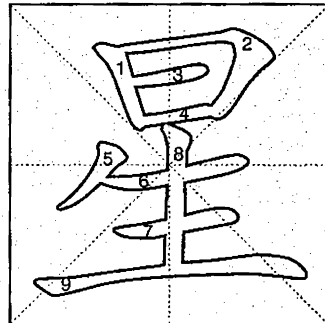

星 xīng 1690

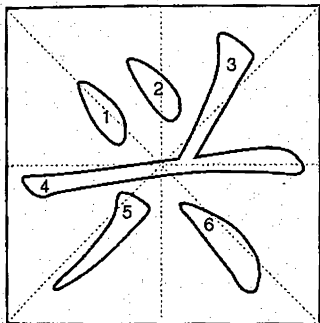

兴 xīng 1691

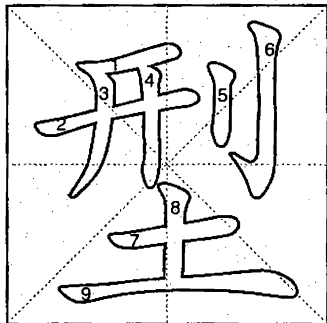

型 xíng 1692

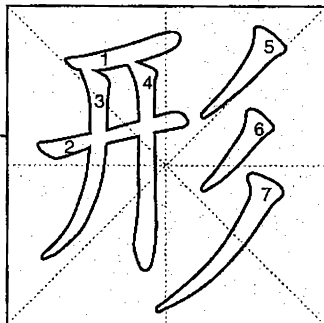

形 xíng 1693

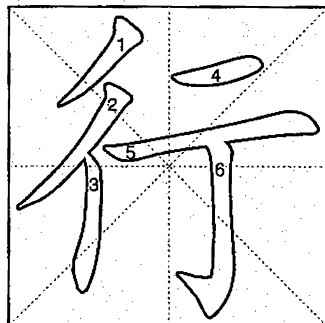

行 xíng 1694

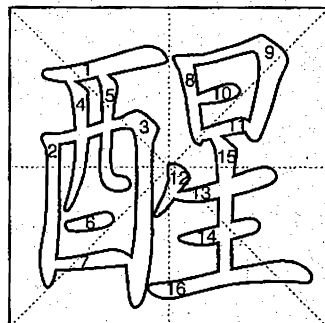

醒 xǐng 1695

### 谢 xiè

① thank ③ (of flowers, leaves) wither  
 谢绝 xiè'jué  
 refuse; decline  
 谢谢 xiè'xiè  
 thanks; thank you  
 谢意 xiè'yì  
 gratitude; thanks

### 卸 xiè

① unload; discharge; lay down  
 ② remove; strip ③ get rid of; shirk (the responsibility)  
 卸车 xiè'chē  
 unload goods, etc. from a vehicle  
 卸货 xiè'huò  
 unload  
 卸任 xiè'rèn  
 be relieved of one's office

### 械 xiè

① tool; instrument ② weapon  
 械斗 xiè'dòu  
 fight with weapons between groups of people

### 写 xiě

① write ② compose  
 写信 xiě'xìn  
 write a letter  
 写字楼 xiě'zì'lóu  
 office building  
 写作 xiě'zuò  
 writing

### 胁 xié

coerce; force  
 胁持 xié'chí  
 hold sb. under duress  
 胁从 xié'cóng  
 be an accomplice under duress  
 胁迫 xié'pò  
 coerce; force

### 星 xīng

① star ② heavenly body ③ bit; particle  
 星斗 xīng'dǒu  
 stars  
 星期 xīng'qī  
 week  
 星期日 xīng'qī'rì  
 Sunday; Sun.

### 信 xìn

① true ② confidence; faith ③ believe ④ profess faith in; believe in ⑤ at will; at random; without plan  
 信贷 xìn'dài  
 credit  
 信函 xìn'hán  
 letters; mail  
 信托 xìn'tuō  
 trust; entrust

### 心 xīn

① the heart  
 ② heart; mind; feeling; intention  
 ③ centre; core  
 心爱 xīn'ài  
 beloved; treasured  
 心搏 xīn'bó  
 heartbeat  
 心地善良 xīn'dì'shàn'liáng  
 kindhearted

### 新 xīn

① new; fresh  
 ② newly; freshly; recently  
 新版 xīn'bǎn  
 new edition  
 新纪元 xīn'jì'yuán  
 new era; new epoch  
 新年 xīn'nián  
 New Year

### 辛 xīn

① hot (in taste, flavour, etc.); pungent ② hard; laborious ③ suffering  
 辛苦 xīn'kǔ  
 hard; laborious  
 辛劳 xīn'láo  
 pains; toil  
 辛酸 xīn'suān  
 sad; bitter; miserable

### 醒 xǐng

① regain consciousness; sober up  
 ② wake up; be awake ③ be clear in mind ④ be striking to the eye  
 醒酒 xǐng'jiǔ  
 sober up  
 醒来 xǐng'lái  
 wake up  
 醒目 xǐng'mù  
 be striking

### 行 xíng

① go ② travel ③ temporary ④ be current; prevail; circulate ⑤ do; perform; carry out; engage in  
 行不通 xíng'bù'tōng  
 won't work  
 行刺 xíng'cì  
 assassinate  
 行贿 xíng'huì  
 bribe; offer a bribe

### 形 xíng

① form; shape ② body; entity  
 ③ appear; look ④ compare  
 形式 xíng'shì  
 form; shape  
 形势 xíng'shì  
 situation; circumstance  
 形象 xíng'xiàng  
 image; figure; form

### 型 xíng

① mould ② type; pattern  
 型号 xíng'hào  
 type, model; size

### 兴 xīng

① prosper; rise; prevail; become popular ② start; begin ③ encourage; promote  
 兴奋 xīng'fèn  
 be excited  
 兴建 xīng'jiàn  
 build; construct  
 兴旺 xīng'wàng  
 prosperous; flourishing

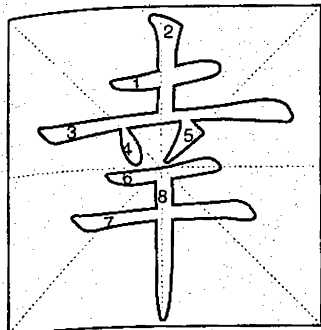

幸 xìng 1696

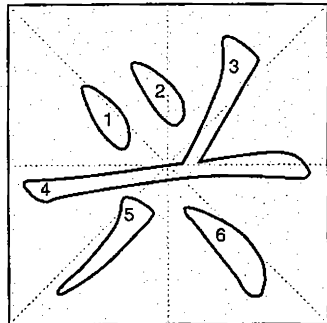

兴 xìng 1697

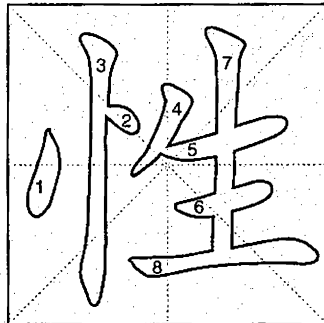

性 xìng 1698

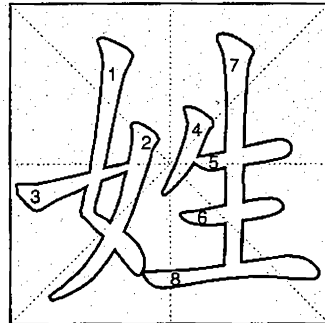

姓 xìng 1699

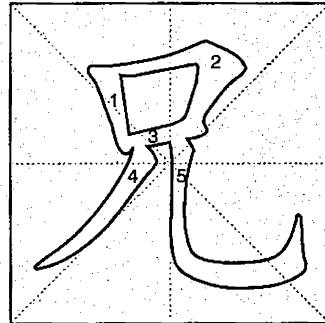

兄 xiōng 1700

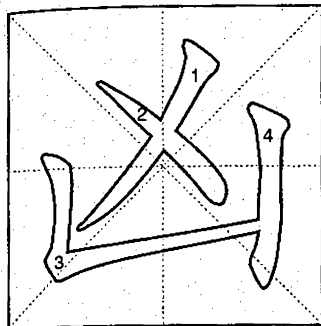

凶 xiōng 1701

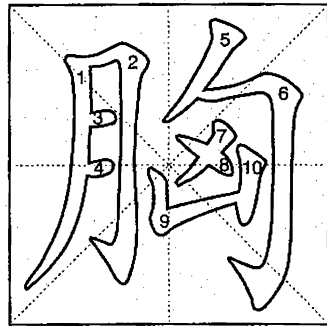

胸 xiōng 1702

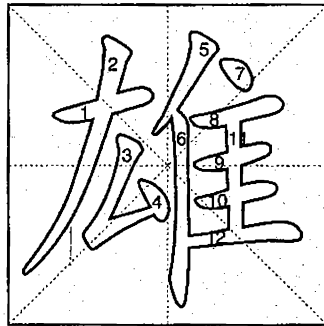

雄 xióng 1703

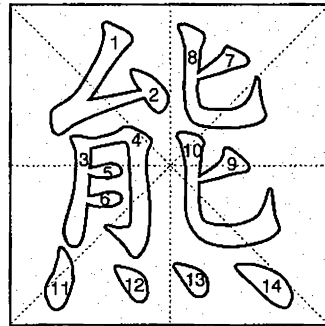

熊 xióng 1704

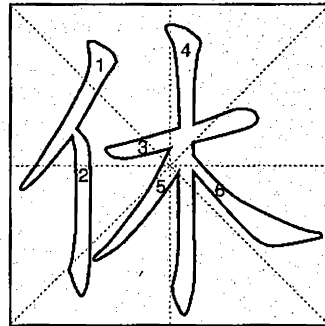

休 xiū 1705

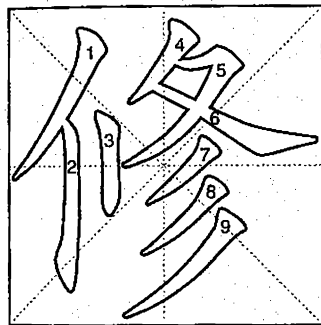

修 xiū 1706

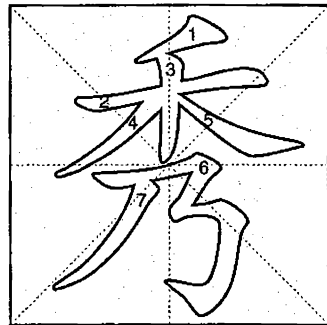

秀 xiù 1707

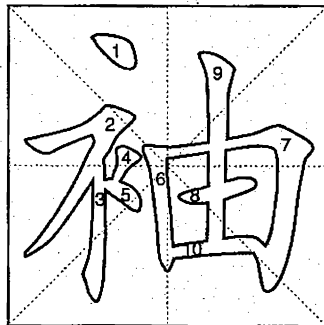

袖 xiù 1708

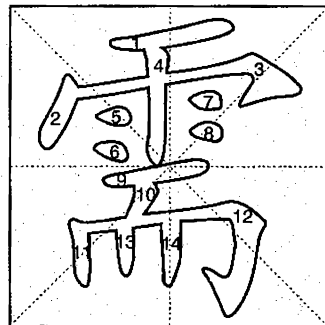

需 xū 1709

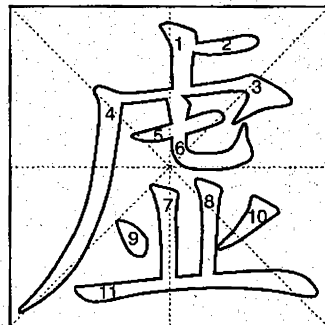

虚 xū 1710



**兄 xiōng**

elder brother  
兄弟 xiōng'dì  
brother

**姓 xìng**

surname; family name  
姓名 xìng'míng  
full name  
姓氏 xìng'shì  
surname

**性 xìng**

① nature; character; disposition  
② property; quality ③ sex ④ gender  
性爱 xìng'ài  
love; sexual love  
性急 xìng'jí  
impatient  
性子 xìng'zi  
temper

**兴 xìng**

mood or desire to do sth.; interest  
兴冲冲 xìng'chōng'chōng  
joyfully; excitedly  
兴高采烈 xìng'gāo'cǎi'liè  
in high spirits  
兴趣 xìng'qù  
interest; taste

**幸 xìng**

① (have) good fortune  
② rejoice ③ luckily  
幸存 xìng'cún  
survive  
幸亏 xìng'kuī  
fortunately; luckily  
幸运儿 xìng'yùn'ér  
fortune's favorite

**休 xiū**

stop; cease  
休会 xiū'huì  
adjourn  
休市 xiū'shì  
close the market  
休息 xiū'xi  
take a rest

**熊 xióng**

bear  
熊猫 xióng'māo  
panda  
熊市(经) xióng'shì(jīng)  
bear market  
熊熊 xióng'xióng  
flaming; ablaze; raging

**雄 xióng**

① male ② grand; imposing  
③ powerful; mighty  
雄兵 xióng'bīng  
a powerful army  
雄伟 xióng'wěi  
grand; magnificent  
雄心 xióng'xīn  
great ambition

**胸 xiōng**

① chest; bosom; thorax  
② mind; heart  
胸脯 xiōng'pú  
chest  
胸围 xiōng'wéi  
chest measurement  
胸针 xiōng'zhēn  
brooch

**凶 xiōng**

① inauspicious; ominous ② crop failure ③ fierce; ferocious ④ terrible; fearful ⑤ act of violence; murder  
凶恶 xiōng'è  
evil; fierce; ferocious  
凶犯 xiōng'fàn  
murderer  
凶狠 xiōng'hěn  
fierce and malicious

**虚 xū**

① void; emptiness ② empty; void; unoccupied ③ diffident; timid ④ in vain ⑤ false; nominal  
虚报 xū'bào  
false report  
虚惊 xū'jīng  
false alarm  
虚弱 xū'ruò  
weak; feeble

**需 xū**

① need; want  
② necessities; needs  
需求 xū'qiú  
requirement; demand  
需要 xū'yào  
need; require; demand

**袖 xiù**

① sleeve  
② tuck inside the sleeve  
袖口 xiù'kǒu  
cuff (of a sleeve)  
袖手旁观 xiù'shǒu'páng'guān  
look on unconcerned  
袖珍 xiù'zhēn  
pocket; pocket-size

**秀 xiù**

① (of grain crops, etc.) put forth flowers or ears ② elegant; beautiful ③ excellent  
秀才 xiù'cái  
scholar; intellectual  
秀丽 xiù'li  
pretty; beautiful  
秀美 xiù'měi  
graceful; elegant

**修 xiū**

① embellish ② repair; overhaul ③ study; cultivate ④ build; construct ⑤ trim; prune  
修订 xiū'dìng  
revise  
修剪 xiū'jiǎn  
prune; trim  
修士 xiū'shì  
brother; friar

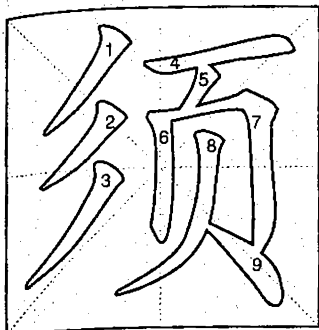

须 xū 1711



许 xǔ 1712

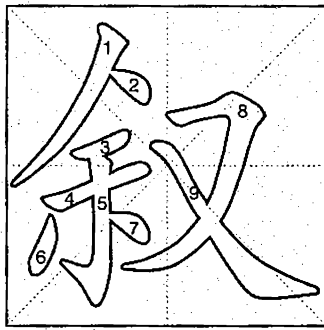

叙 xù 1713

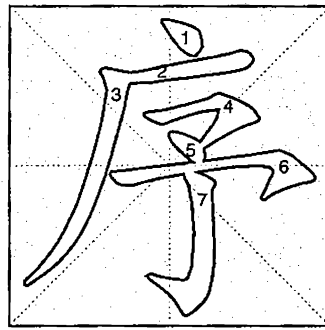

序 xù 1714

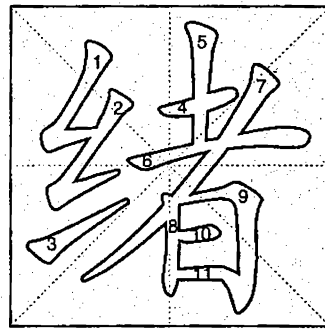

绪 xù 1715

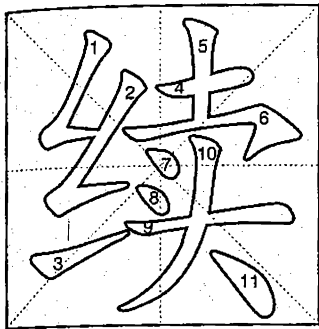

续 xù 1716

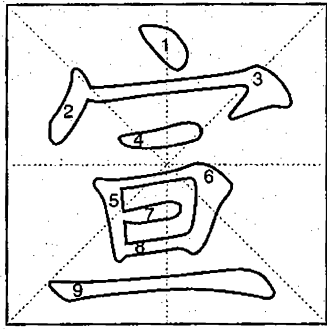

宣 xuān 1717

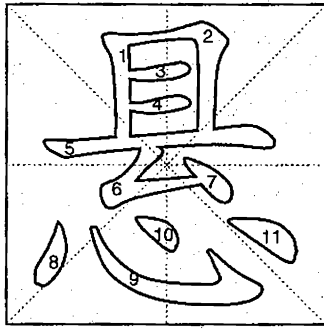

悬 xuán 1718

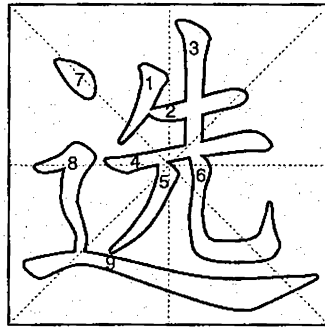

选 xuǎn 1719

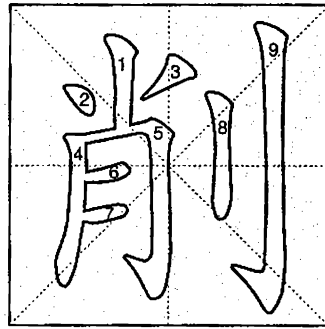

削 xuē 1720

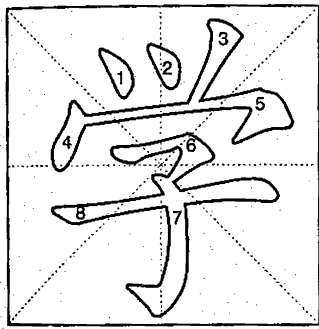

学 xué 1721

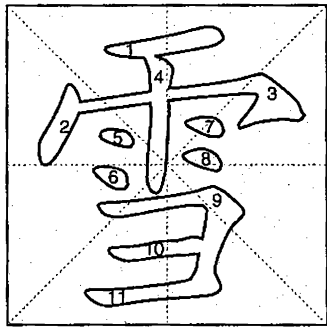

雪 xuě 1722

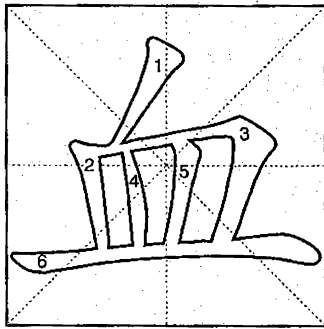

血 xuè 1723

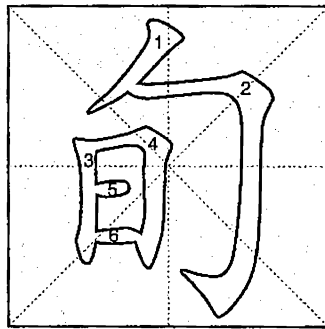

旬 xún 1724

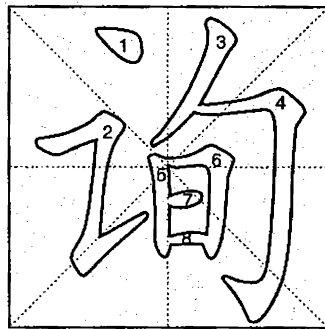

询 xún 1725

### 绪 xù

thread  
 绪论 xù'lùn  
 introduction  
 绪言 xù'yán  
 introduction

### 序 xù

①order; sequence  
 ②preface; foreword  
 序曲 xù'qǔ  
 overture  
 序数 xù'shù  
 ordinal number  
 序言 xù'yán  
 preface; forward

### 叙 xù

①talk; chat ②narrate; relate  
 ③assess; appraise  
 叙旧 xù'jiù  
 talk about the old days  
 叙述 xù'shù  
 recite; narrate recount  
 叙谈 xù'tán  
 talk together; chat

### 许 xǔ

①praise ②allow; permit  
 ③promise ④maybe  
 许多 xǔ'duō  
 many; much; a lot of  
 许久 xǔ'jiǔ  
 for a long time; for ages  
 许可证 xǔ'kě'zhèng  
 license; permit

### 须 xū

①must; have to  
 ②beard; mustache  
 须发 xū'fà  
 beard and hair  
 须要 xū'yào  
 must; have to  
 须子 xū'zi  
 palpus; feeler; tassel

### 削 xuē

pare; cut  
 削价 xuē'jià  
 lower the price  
 削减 xuē'jiǎn  
 cut down; reduce  
 削弱 xuē'ruò  
 weaken

### 选 xuǎn

①select; choose; pick ②elect  
 ③selections; anthology  
 选举 xuǎn'jǔ  
 elect; vote; election  
 选民 xuǎn'mǐn  
 voter; elector  
 选票 xuǎn'piào  
 vote; ballot

### 悬 xuán

①hang; suspend ②outstanding;  
 unresolved ③far apart  
 悬案 xuán'àn  
 unsettled law case  
 悬挂 xuán'guà  
 suspend; hang  
 悬崖 xuán'yá  
 cliff; precipice

### 宣 xuān

declare; announce  
 宣布 xuān'bù  
 declare; proclaim  
 宣告 xuān'gào  
 proclaim  
 宣言 xuān'yán  
 declaration; manifesto

### 续 xù

①continuous; successive  
 ②continue; extend; join  
 ③add; supply more  
 续订 xù'dìng  
 renew one's subscription  
 续集 xù'jí  
 continuation (of a book)  
 续聘 xù'pìn  
 resign

### 询 xún

ask; inquire  
 询问 xún'wèn  
 ask about; inquire

### 旬 xún

①a period of ten days  
 ②a period of ten years in a person's age

### 血 xuè

①blood ②related by blood  
 血案 xuè'àn  
 murder case  
 血管 xuè'guǎn  
 blood vessel  
 血库 xuè'kù  
 blood bank

### 雪 xuě

①snow  
 ②wipe out (a humiliation)  
 雪白 xuě'bái  
 snow-white  
 雪雕 xuě'diāo  
 snow sculpture  
 雪糕 xuě'gāo  
 ice-cream

### 学 xué

①study; learn ②imitate  
 ③learning; knowledge ④school;  
 college  
 学分 xué'fēn  
 credit  
 学历 xué'lì  
 educational background  
 学士 xué'shì  
 scholar; bachelor

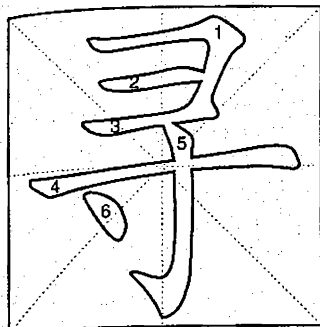

寻 xún 1726

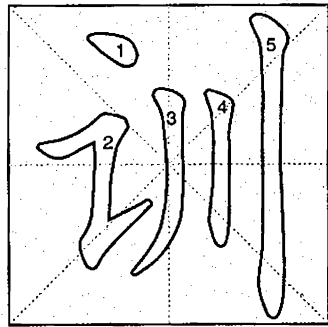

训 xùn 1727

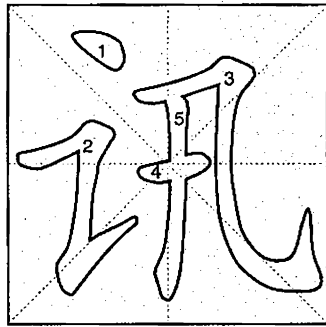

讯 xùn 1728

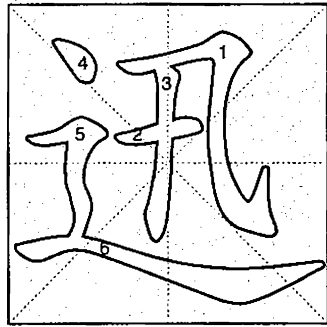

迅 xùn 1729

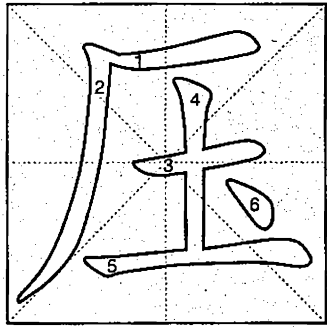

压 yā 1730

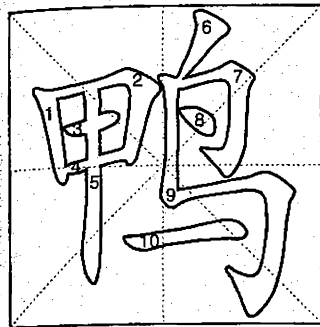

鸭 yā 1731

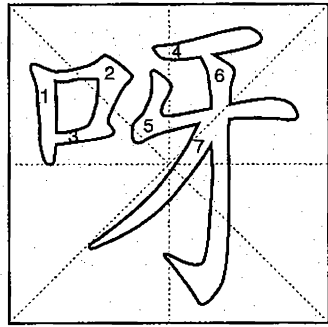

呀 yā 1732

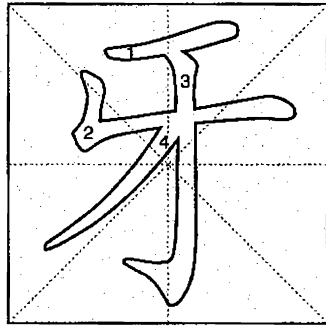

牙 yá 1733

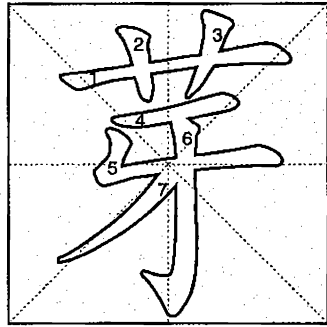

芽 yá 1734

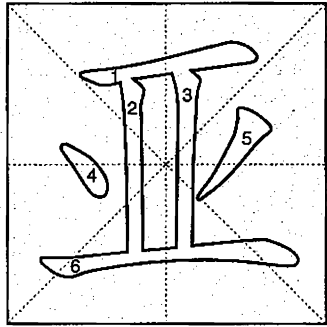

亚 yà 1735

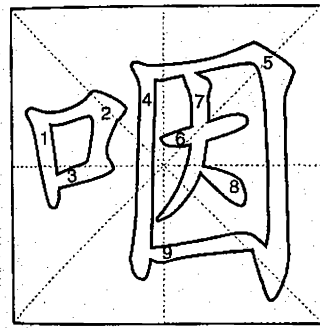

咽 yān 1736

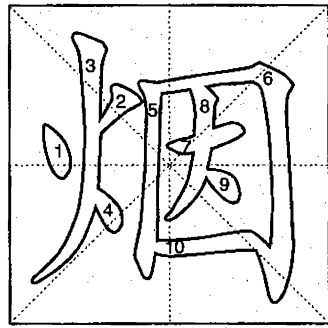

烟 yān 1737

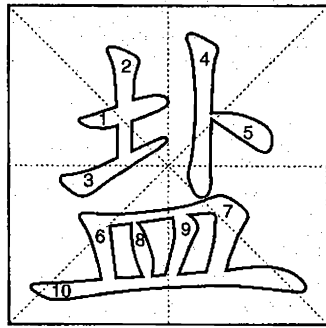

盐 yán 1738

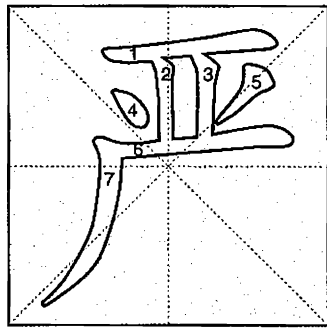

严 yán 1739

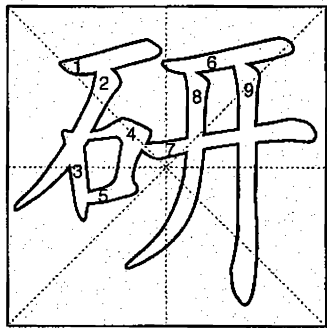

研 yán 1740

### 压 yā

- ①press; push down; weigh down  
 ②control; keep under; quell  
 ③suppress; daunt; intimidate  
 压力 yā' lì  
 pressure  
 压平 yā' píng  
 flatten; even  
 压迫 yā' pò  
 oppress; repress

### 迅 xùn

- fast; swift  
 迅即 xùn' jí  
 immediately; at once  
 迅猛 xùn' měng  
 swift; rapid  
 迅速 xùn' sù  
 rapid; swift; speedy

### 讯 xùn

- message; dispatch  
 讯问 xùn' wèn  
 interrogate; question  
 讯息 xùn' xī  
 message

### 训 xùn

- lecture; teach; train  
 训词 xùn' cí  
 instructions  
 训练 xùn' liàn  
 train; drill  
 训令 xùn' lìng  
 written instruction

### 寻 xún

- search; seek  
 寻常 xún' cháng  
 common; usual; ordinary  
 寻访 xún' fǎng  
 look for  
 寻找 xún' zhǎo  
 seek; look for

### 亚 yà

- inferior; second  
 亚军 yà' jūn  
 second place; runner-up  
 亚麻(植) yà' má( zhí)  
 flax  
 亚洲 yà' zhōu  
 Asia

### 芽 yá

- bud; sprout; shoot  
 豆芽 dòu' yá  
 bean sprout

### 牙 yá

- ①tooth ②ivory  
 牙齿 yá' chǐ  
 tooth  
 牙膏 yá' gāo  
 toothpaste  
 牙刷 yá' shuā  
 toothbrush

### 呀 yā

- ah; oh

### 鸭 yā

- duck  
 鸭蛋 yā' dàn  
 duck's egg  
 鸭梨 yā' lí  
 pear  
 鸭子 yā' zi  
 duck

### 研 yán

- ①grind; pestle ②study  
 研究 yán' jiū  
 study; research  
 研究生 yán' jiū' shēng  
 graduate student  
 研制 yán' zhì  
 prepare; develop

### 严 yán

- ①tight ②strict; severe; rigorous  
 严冬 yán' dōng  
 severe winter  
 严厉 yán' lì  
 stern; severe  
 严刑 yán' xíng  
 cruel torture

### 盐 yán

- salt  
 盐井 yán' jǐng  
 salt well  
 盐矿 yán' kuàng  
 salt mine  
 盐业 yán' yè  
 salt industry

### 烟 yān

- ①smoke ②tobacco  
 ③cigarette ④opium  
 烟草 yān' cǎo  
 tobacco  
 烟斗 yān' dòu  
 (tobacco) pipe  
 烟花 yān' huā  
 fireworks

### 咽 yān

- pharynx  
 咽喉 yān' hóu  
 throat  
 咽头 yān' tóu  
 pharynx  
 咽炎(医) yān' yán( yī)  
 pharyngitis

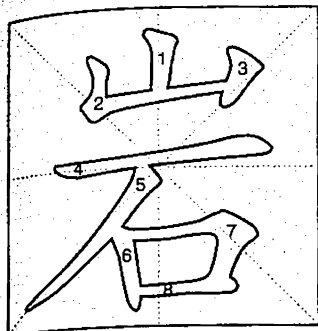

岩 yán 1741

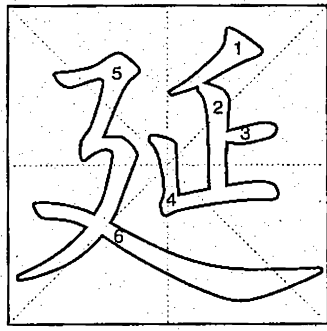

延 yán 1742

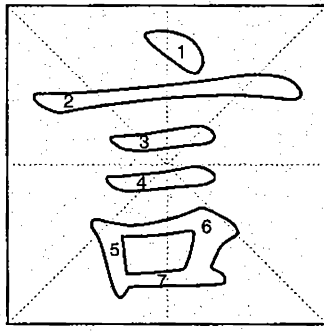

言 yán 1743

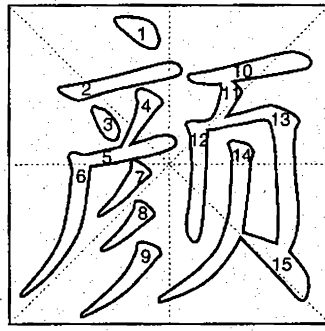

顏 yán 1744

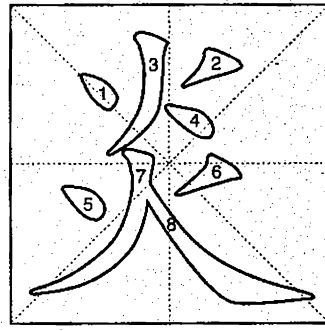

炎 yán 1745

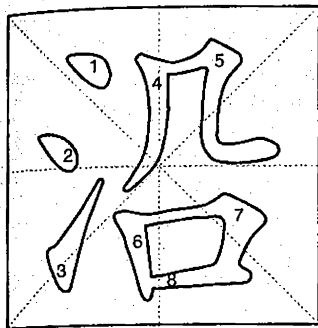

沿 yán 1746

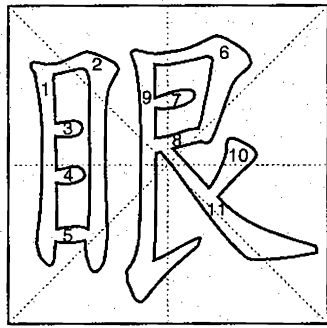

眼 yǎn 1747

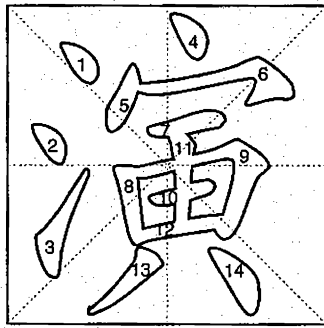

演 yǎn 1748

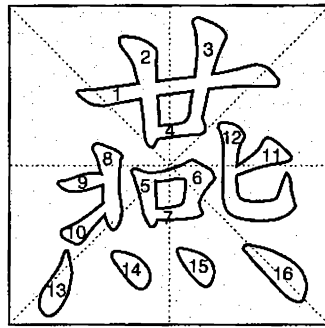

燕 yàn 1749

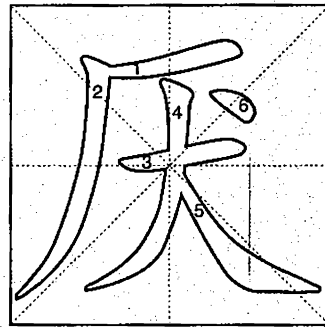

厭 yàn 1750

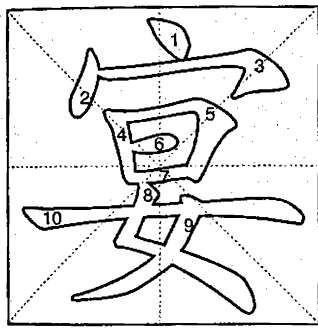

宴 yàn 1751

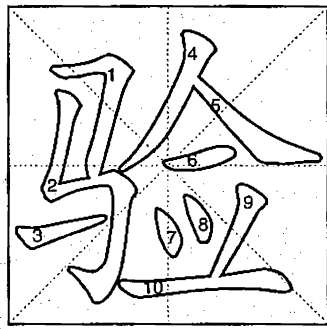

驗 yàn 1752

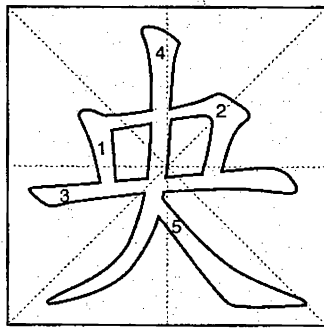

央 yāng 1753

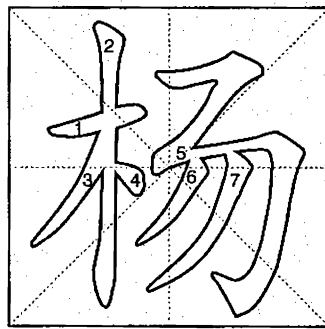

楊 yáng 1754

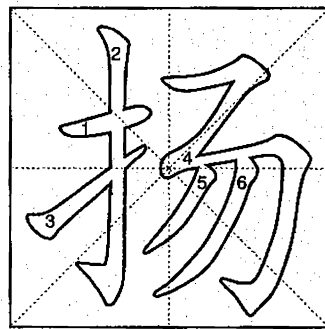

揚 yáng 1755

### 炎 yán

- ①scorching; burning hot  
 ②inflammation  
 炎热 yán'rè  
 scorching; blazing  
 炎夏 yán'xià  
 hot summer  
 炎症 yán'zhèng  
 inflammation

### 颜 yán

- ①face; countenance  
 ②prestige ③colour  
 颜料 yán'liào  
 colour; dyestuff  
 颜面 yán'miàn  
 face; prestige; dignity  
 颜色 yán'sè  
 colour; countenance

### 言 yán

- ①speech; word ②say; talk; speak  
 ③character; word  
 言和 yán'hé  
 make peace  
 言听计从 yán'tīng'jì'cóng  
 always follow sb.'s advice  
 言行 yán'xíng  
 words and deeds

### 延 yán

- ①prolong; extend; protract  
 ②postpone; delay ③engage  
 延长 yán'cháng  
 prolong; extend; lengthen  
 延期 yán'qī  
 postpone; defer  
 延伸 yán'shēn  
 extend; stretch

### 岩 yán

- ①rock ②cliff; crag  
 岩层 yán'céng  
 rock stratum  
 岩洞 yán'dòng  
 grotto  
 岩石 yán'shí  
 rock

### 厌 yàn

- ①be disgusted with  
 ②be tired of  
 厌烦 yàn'fán  
 be fed up with  
 厌恶 yàn'wù  
 detest; abhor  
 厌战 yàn'zhàn  
 be weary of war

### 燕 yàn

- swallow  
 燕麦 yàn'mài  
 oats  
 燕尾服 yàn'wěi'fú  
 swallowtail  
 燕子 yàn'zi  
 swallow

### 演 yǎn

- ①develop; evolve ②elaborate  
 ③drill; practise ④perform; play;  
 act; put on  
 演唱 yǎn'chàng  
 sing (in a performance)  
 演说 yǎn'shuō  
 deliver a speech  
 演员 yǎn'yuán  
 actor or actress

### 眼 yǎn

- ①eye ②look; glance ③small  
 hole; aperture ④key point  
 眼光 yǎn'guāng  
 eye; sight  
 眼镜蛇 yǎn'jìng'shé  
 cobra  
 眼睛 yǎn'jīng  
 eye

### 沿 yán

- ①along ②follow (a tradition,  
 pattern, etc.) ③edge; border  
 沿岸 yán'àn  
 along the bank or coast  
 沿海 yán'hǎi  
 along the coast  
 沿途 yán'tú  
 on the way

### 扬 yáng

- ①raise ②throw up and scatter;  
 winnow (the chaff from the grain)  
 ③spread; make known  
 扬声器 yáng'shēng'qì  
 loudspeaker  
 扬言 yáng'yán  
 threaten

### 杨 yáng

- poplar  
 杨柳 yáng'liǔ  
 poplar and willow  
 杨梅 yáng'méi  
 red bayberry  
 杨树 yáng'shù  
 poplar

### 央 yāng

- ①entreat ②centre ③end; finish  
 央告 yāng'gào  
 beg; ask earnestly  
 央行 yāng'háng  
 central bank  
 央求 yāng'qiú  
 beg; plead; implore

### 验 yàn

- ①examine; check; test ②prove  
 effective; produce the expected result  
 验方 yàn'fāng  
 proved recipe  
 验光 yàn'guāng  
 optometry  
 验血 yàn'xiě  
 blood test

### 宴 yàn

- ①entertain at a banquet  
 ②feast  
 宴会 yàn'huì  
 banquet; feast  
 宴请 yàn'qǐng  
 entertain; fête  
 宴席 yàn'xí  
 banquet; feast

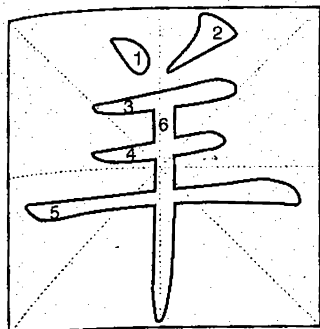

羊 yáng 1756

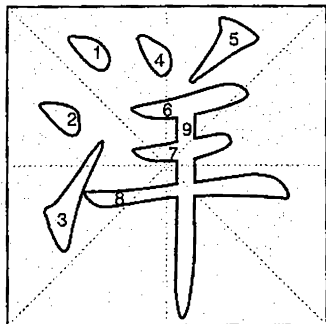

洋 yáng 1757

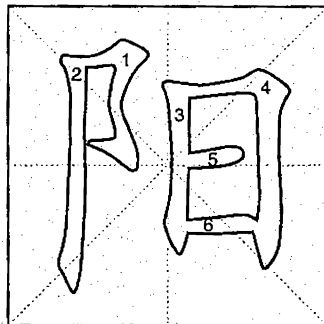

阳 yáng 1758

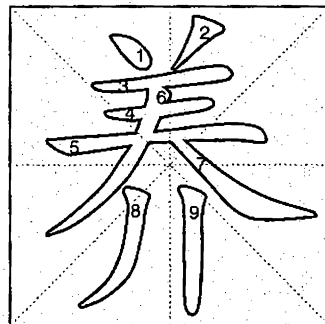

养 yǎng 1759

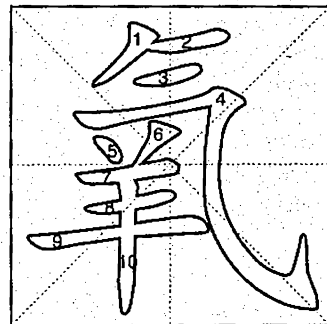

氧 yǎng 1760

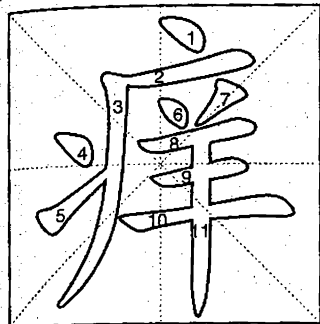

痒 yǎng 1761

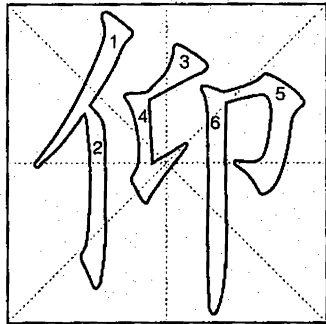

仰 yǎng 1762

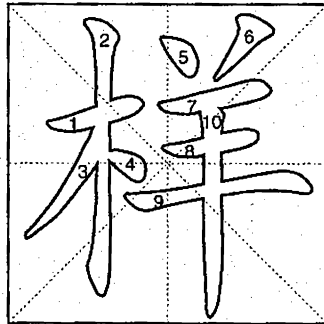

样 yàng 1763

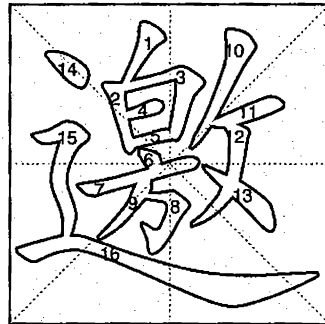

邀 yāo 1764

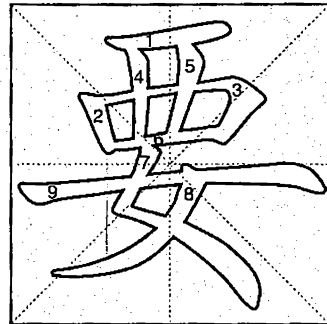

要 yāo 1765

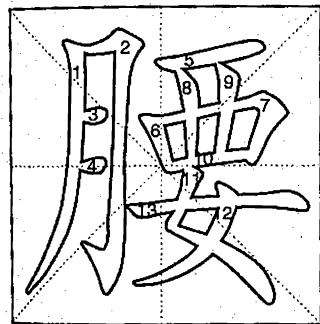

腰 yāo 1766

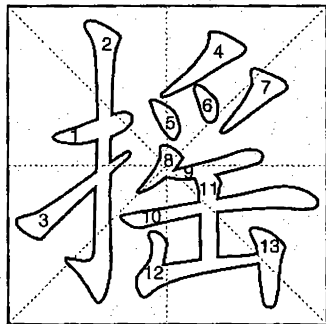

摇 yáo 1767

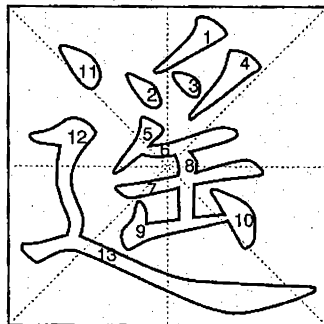

遥 yáo 1768

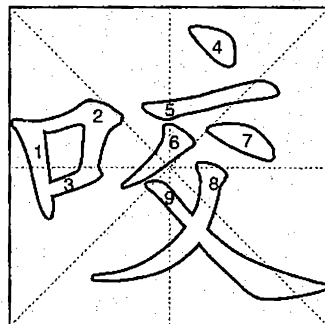

咬 yǎo 1769

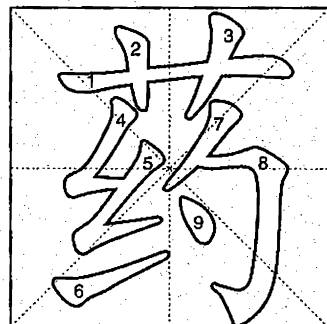

药 yào 1770



氧(化) yǎng(huà)

oxygen  
氧吧 yǎng'bā  
oxygen bar  
氧气 yǎng'qì  
oxygen  
氧气面罩 yǎng'qì miàn'zhào  
oxygen mask

养 yǎng

① provide for ② raise ③ give birth to ④ foster; adoptive ⑤ form; acquire ⑥ rest; convalesce  
养分 yǎng'fèn  
nutrient  
养花 yǎng'huā  
grow flowers  
养老金 yǎng'lǎo'jīn  
old-aged pension

阳 yáng

① the sun ② in relief ③ belonging to this world ④ positive  
阳光 yáng'guāng  
sunlight; sunshine  
阳伞 yáng'sǎn  
parasol; sunshade  
阳台 yáng'tái  
balcony

洋 yáng

① vast; multitudinous ② ocean  
③ foreign ④ modern  
洋白菜 yáng'bái'cài  
cabbage  
洋人 yáng'rén  
foreigner  
洋娃娃 yáng'wá'wa  
doll

羊 yáng

sheep  
羊羔 yáng'gāo  
lamb  
羊毛 yáng'máo  
sheep's wool; fleece  
羊绒衫 yáng'róng'shān  
cashmere sweater

要 yào

① demand; ask ② force; coerce  
要求 yào'qiú  
ask; demand; require  
要挟 yào'xié  
coerce; threaten

邀 yāo

invite; request  
邀集 yāo'jí  
invite to meet together  
邀请 yāo'qǐng  
invite  
邀请赛 yāo'qǐng'sài  
invitational tournament

样 yàng

① appearance; shape ② sample; model; pattern ③ kind; type  
样板 yàng'bǎn  
sample plate; templet  
样本 yàng'běn  
sample book  
样书 yàng'shū  
sample book

仰 yǎng

① face upward  
② admire; respect  
仰面 yǎng'miàn  
face upward  
仰望 yǎng'wàng  
look up at  
仰泳(体) yǎng'yǒng(ǐ)  
backstroke

痒 yǎng

itch; tickle  
痒痒 yǎng'yang  
itch; tickle  
痒痒挠 yǎng'yang'náo  
back-scratcher

药 yào

① medicine; drug; remedy  
② certain chemicals  
③ kill with poison  
药房 yào'fáng  
drugstore; pharmacy  
药水 yào'shuǐ  
liquid medicine; lotion  
药丸 yào'wán  
pill; bolus

咬 yǎo

① bite; snap at ② (of a dog) bark  
③ pronounce ④ be nitpicking (on words)  
咬定 yǎo'dìng  
insist  
咬伤 yǎo'shāng  
bite  
咬住 yǎo'zhù  
bite into; grip

遥 yáo

distant; remote; far  
遥控器 yáo'kòng'qì  
remote controller  
遥望 yáo'wàng  
look into the distance  
遥远 yáo'yuǎn  
distant; remote

摇 yáo

shake; rock; turn  
摇滚乐 yáo'gǎn'yuè  
big beat; rock'n'roll  
摇手 yáo'shǒu  
wave one's hand  
摇头 yáo'tóu  
shake one's head

腰 yāo

① waist; small of the back  
② waist (of a garment)  
腰包 yāo'bāo  
purse; pocket; wallet  
腰带 yāo'dài  
waistband; belt  
腰果 yāo'guǒ  
cashew; cashew nut

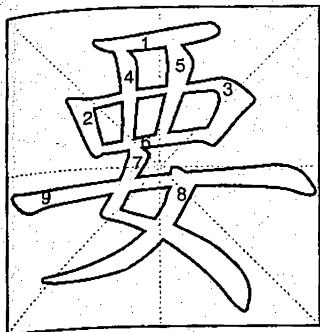

要 yào 1771

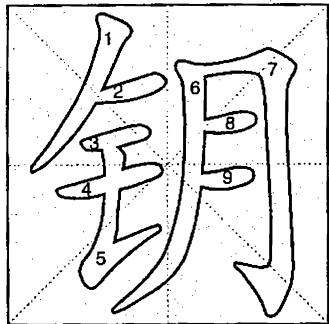

钥 yào 1772

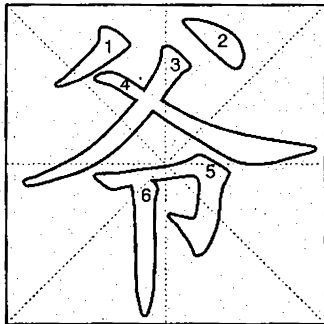

斧 fǔ 1773

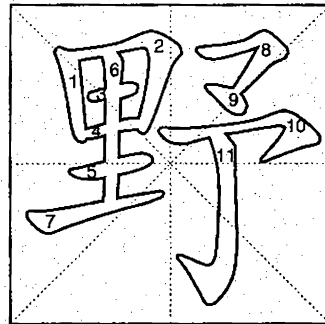

野 yě 1774

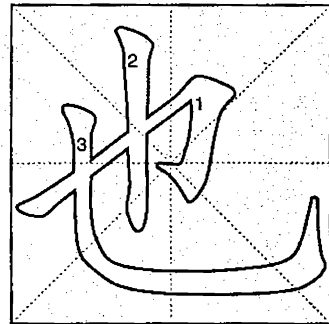

也 yě 1775

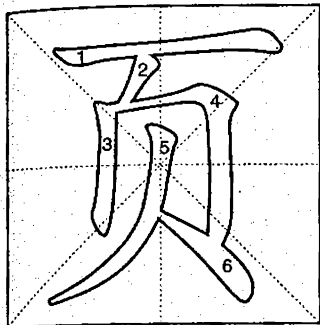

页 yè 1776

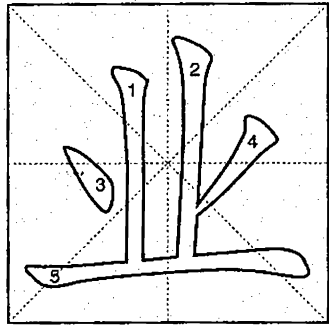

业 yè 1777

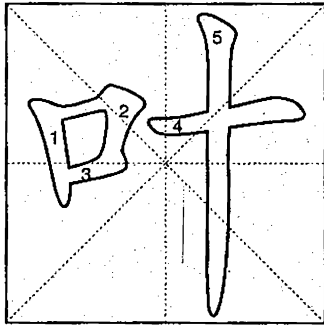

叶 yè 1778

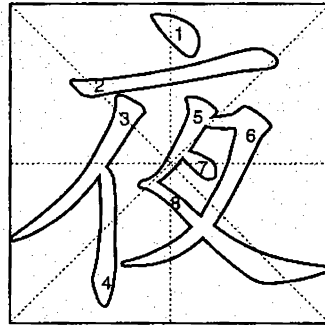

夜 yè 1779

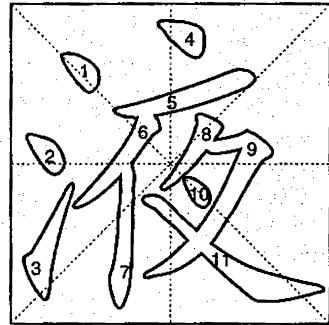

液 yè 1780

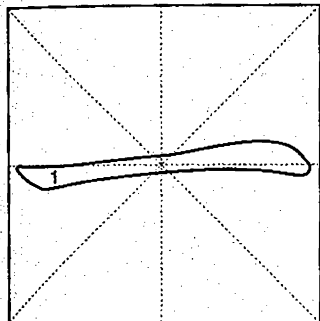

一 yī 1781

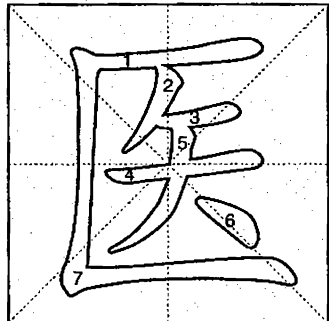

医 yī 1782

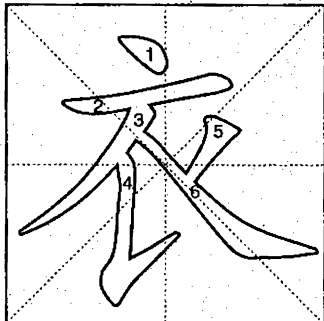

衣 yī 1783

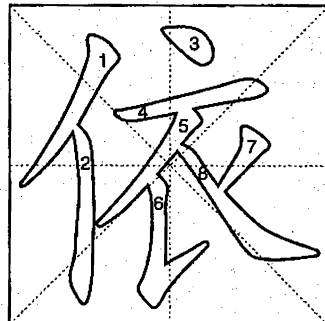

依 yī 1784

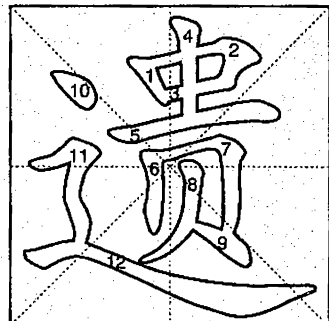

遗 yí 1785

### 也 yě

also; too; as well; either  
 也罢 yě'ba  
 all right  
 也好 yě'hǎo  
 may as well  
 也许〈副〉 yě'xǔ〈fù〉  
 perhaps; probably

### 野 yě

①open country; the open ②limit;  
 boundary ③ not in power; out of  
 office ④wild; uncultivated; undom-  
 esticated  
 野菜 yě'cài  
 edible wild herds  
 野餐 yě'cān  
 picnic  
 野果 yě'guǒ  
 wild fruit

### 爷 yé

①father ②grandfather  
 爷们 yé'men  
 man; menfolk; husband  
 爷爷 yé'ye  
 grandfather; grandpa

### 钥 yào

钥匙 yào'shi  
 key

### 要 yào

① important; essential ② want;  
 ask for; wish; desire ③ask sb. to do  
 sth. ④ want to; wish to ⑤ must;  
 should; it is necessary  
 要不 yào'bù  
 otherwise; or else; or  
 要犯 yào'fàn  
 important criminal  
 要饭 yào'fàn  
 beg; go begging

### 液 yè

liquid; fluid; juice  
 液化器 yè'huà'qì  
 liquefier  
 液晶〈物〉 yè'jīng〈wù〉  
 liquid crystal  
 液体 yè'tǐ  
 liquid

### 夜 yè

night; evening  
 夜班 yè'bān  
 night shift  
 夜光表 yè'guāng'biǎo  
 luminous watch  
 夜总会 yè'zǒng'huì  
 nightclub

### 叶 yè

①leaf; foliage  
 ②part of a historical period  
 叶绿素(生化)  
 yè'lǜ'sù(shēng'huà)  
 chlorophyll  
 叶片 yè'piàn  
 blade; vane  
 叶子 yè'zi  
 leaf

### 业 yè

①line of business; trade; industry  
 ②occupation; profession; employ-  
 ment; job ③course of study ④cause  
 ⑤estate ⑥engage in ⑦already  
 业内 yè'nèi  
 in the business  
 业务 yè'wù  
 vocational work  
 业余爱好 yè'yú'ài'hào  
 hobby

### 页 yè

page; leaf  
 页边 yè'biān  
 margin  
 页码 yè'mǎ  
 page number  
 页岩〈地〉 yè'yán〈dì〉  
 shale

### 遗 yí

①lose ②omit ③leave behind (at  
 one's death); bequeath; hand down  
 遗产 yí'chǎn  
 legacy; inheritance  
 遗忘 yí'wàng  
 forget  
 遗嘱 yí'zhǔ  
 will; dying words

### 依 yī

①depend on  
 ②comply with; listen to; yield to  
 ③according to  
 依法 yī'fǎ  
 according to the law  
 依仗 yī'zhàng  
 rely on  
 依照 yī'zhào  
 according to

### 衣 yī

①clothing; clothes; garment  
 ②coating; covering  
 衣服 yī'fu  
 clothing; clothes  
 衣钩 yī'gōu  
 clothes hook  
 衣领 yī'lǐng  
 collar

### 医 yī

①doctor (of medicine) ②medical  
 science; medical service; medicine  
 ③cure; treat  
 医护人员 yī'hù'rén'yuán  
 doctors and nurses  
 医生 yī'shēng  
 doctor  
 医院 yī'yuàn  
 hospital

### 一 yī

①one ②alone; only one ③same  
 ④ whole; all; throughout ⑤ each;  
 per; every time  
 一百 yī'bǎi  
 one hundred  
 一半 yī'bàn  
 one half; half; in part  
 一包 yī'bāo  
 a parcel; a package

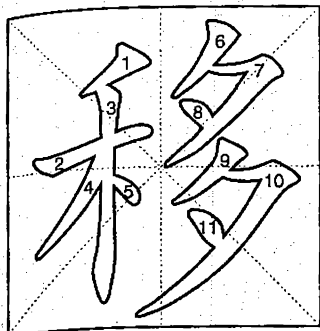

移 yí 1786

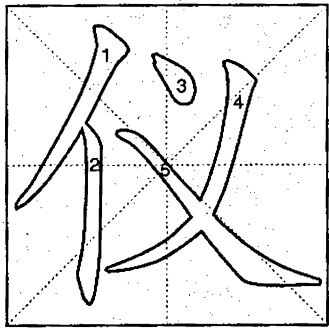

仪 yí 1787

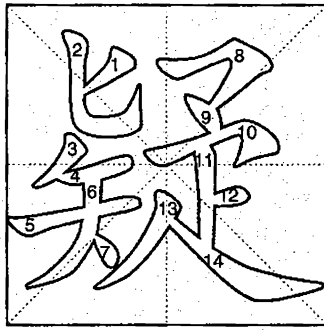

疑 yí 1788

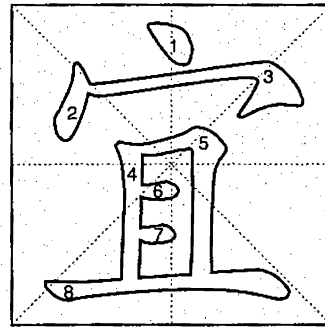

宜 yí 1789

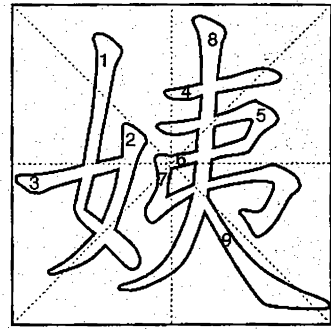

姨 yí 1790

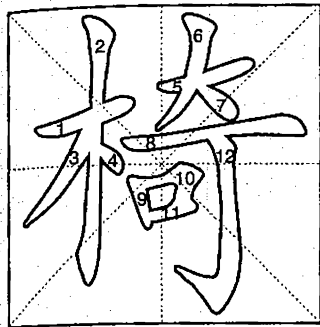

椅 yǐ 1791

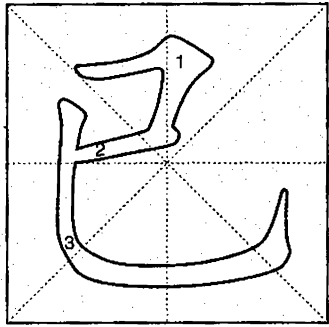

巳 yǐ 1792

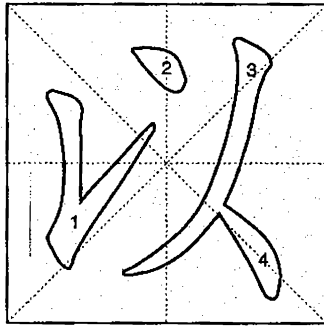

以 yǐ 1793

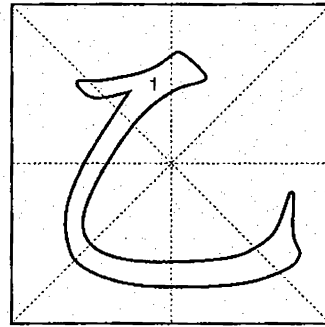

乙 yǐ 1794

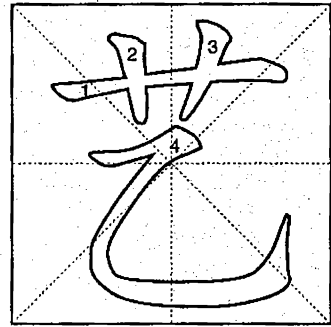

艺 yì 1795

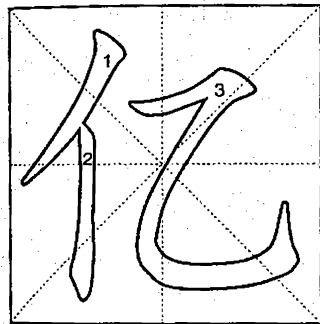

亿 yì 1796

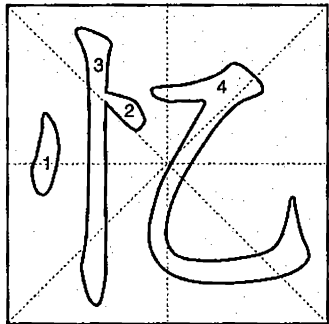

忆 yì 1797

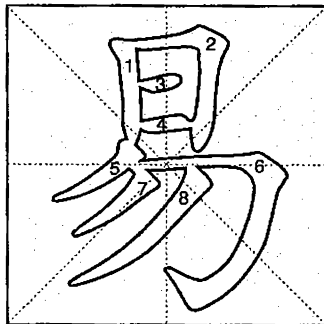

易 yì 1798

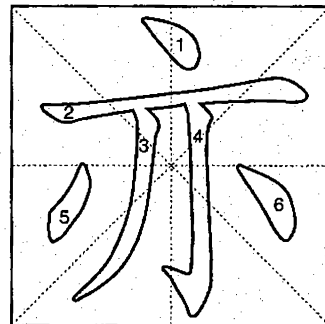

亦 yì 1799

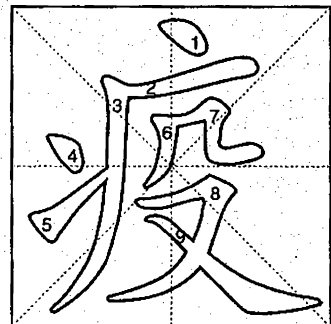

疲 yì 1800

### 姨 yí

①one's mother's sister; aunt

②one's wife's sister

姨表 yí'biǎo

maternal cousin

姨父 yí'fù

uncle

姨母 yí'mǔ

aunt

### 宜 yí

①suitable; appropriate; fitting

②should; ought to

宜人 yí'rén

pleasant; delightful

### 疑 yí

①doubt; disbelieve; suspect

②doubtful; uncertain

疑问 yí'wèn

query; question; doubt

疑凶 yí'xiōng

murderer suspect

疑义 yí'yì

doubt; doubtful point

### 仪 yí

①appearance ②rite ③gift

④apparatus; instrument

仪器 yí'qì

instrument; apparatus

仪式 yí'shì

ceremony; rite

仪仗队 yí'zhàng'duì

honour guard

### 移 yí

①move; remove; shift

②change; alter

移动 yí'dòng

move; shift

移交 yí'jiāo

turn over; transfer

移民 yí'mín

migrate; emigrate (移出); immigrate (移入)

### 艺 yì

skill

艺人 yì'rén

actor or artist; artisan

艺术 yì'shù

art; skill; craft

艺术体操 yì'shù'tǐ'cāo

rhythmic gymnastics

### 乙 yǐ

second

乙醇 yǐ'chún

ethanol; alcohol

乙炔 yǐ'quē

ethyne

乙烯 yǐ'xī

ethylene

### 以 yǐ

①use; take ②according to

③because of ④in order to; so as to

以后 yǐ'hòu

after; afterwards

以及 yǐ'jí

as well as; and

以内 yǐ'nèi

within; less than

### 已 yǐ

①stop; cease; end ②already

已付 yǐ'fù

paid; pd

已婚 yǐ'hūn

be married

已经 yǐ'jīng

already

### 椅 yǐ

chair

椅子 yǐ'zi

chair

椅子套 yǐ'zi'tào

loose cover

### 疫 yì

epidemic disease; pestilence

疫病 yì'bìng

epidemic disease

疫苗 yì'miáo

vaccine

疫情 yì'qíng

epidemic situation

### 亦 yì

also; too

亦步亦趋 yì'bù'yì'qū

imitate sb.'s every move

亦即 yì'jí

that is; i.e.; namely

### 易 yì

①easy ②amiable ③change

④exchange

易手 yì'shǒu

change hands

易碎 yì'suì

breakable; fragile;

易损 yì'sǔn

fragile

### 忆 yì

recall; recollect

忆旧 yì'jiù

recollect the past

忆起 yì'qǐ

remember; recall

### 亿 yì

a hundred million

亿万 yì'wàn

hundreds of millions

亿万富翁 yì'wàn'fù'wēng

billionaire

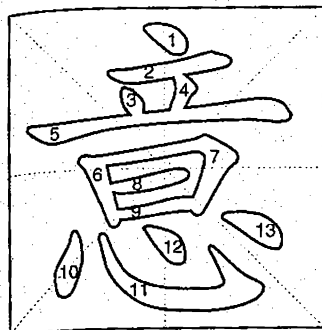

意 yì 1801

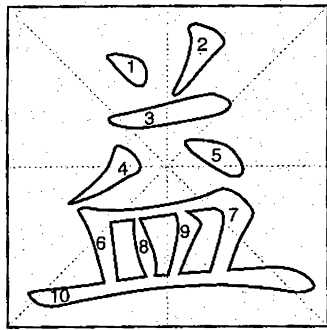

益 yì 1802

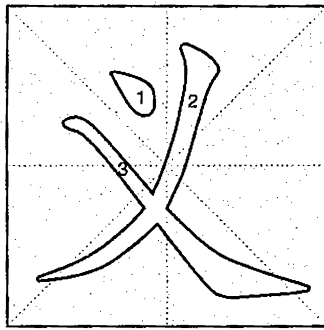

义 yì 1803

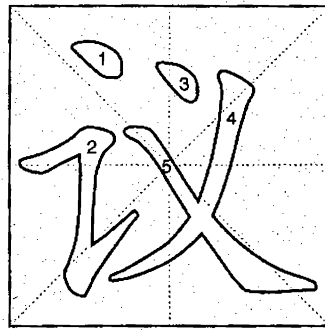

议 yì 1804

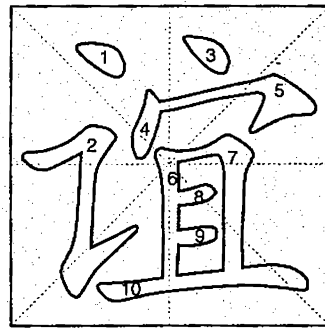

谊 yì 1805

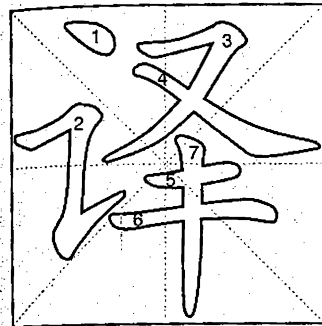

译 yì 1806

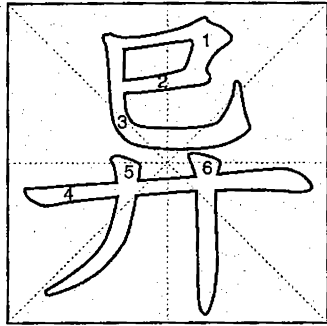

异 yì 1807

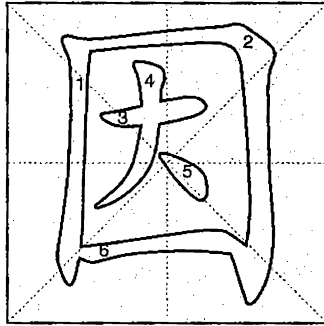

因 yīn 1808

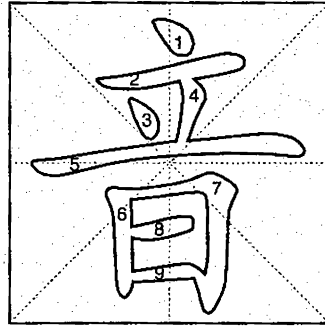

音 yīn 1809

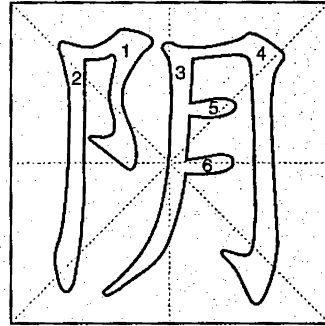

阴 yīn 1810

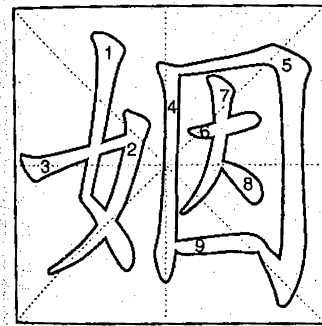

姻 yīn 1811

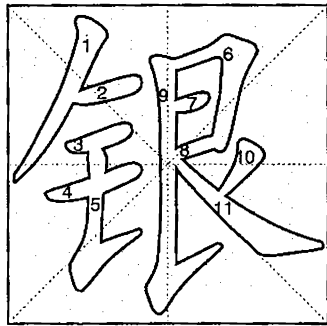

银 yín 1812

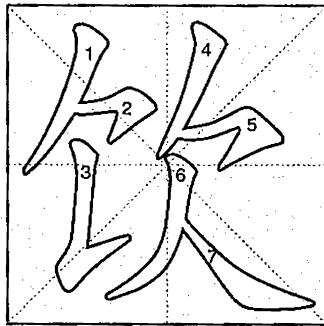

饮 yǐn 1813

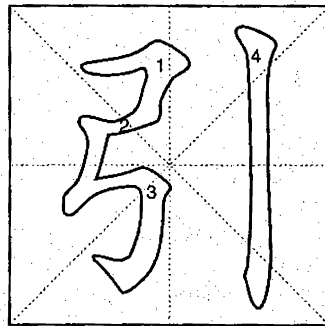

引 yǐn 1814

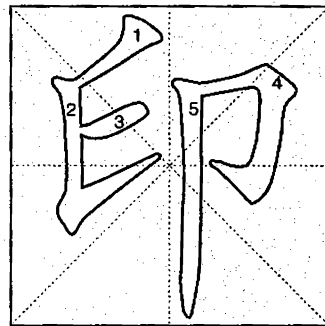

印 yìn 1815

### 谊 yì

friendship  
友谊 yǒu'yì  
friendship

### 议 yì

opinion; discuss  
议程 yì'chéng  
agenda  
议和 yì'hé  
negotiate peace  
议员 yì'yuán  
Member of Parliament(英);  
Congressman or Congresswoman  
(美)

### 义 yì

① justice; righteousness ② equitable; just ③ significance ④ adopted; adoptive  
义工 yì'gōng  
voluntary work without pay  
义气 yì'qì  
code of brotherhood  
义演 yì'yǎn  
benefit performance

### 益 yì

① benefit; profit; advantage  
② beneficial ③ increase ④ all the more; increasingly  
益虫 yì'chóng  
beneficial insect  
益鸟 yì'niǎo  
beneficial bird  
益友 yì'yǒu  
friend and mentor

### 意 yì

① meaning; idea ② wish; desire; anticipate; expect ③ suggestion; hint; trace  
意大利馅饼 yì'dà'lì'xiàn'bǐng  
pizza  
意外 yì'wài  
unexpected; accident  
意译 yì'yì  
free translation

### 阴 yīn

① the moon ② overcast ③ shade  
④ in intaglio ⑤ hidden; secret  
⑥ of the nether world ⑦ negative  
阴暗 yīn'àn  
dark; gloomy  
阴电 yīn'diàn  
negative electricity  
阴天 yīn'tiān  
overcast sky; cloudy day

### 音 yīn

① sound ② news; tidings ③ tone  
音标 yīn'biāo  
phonetic alphabet  
音波 yīn'bō  
sound wave  
音像商店 yīn'xiàng'shāng'diàn  
video shop

### 因 yīn

① follow; carry on ② in accordance with; in the light of  
因此 yīn'cǐ  
therefore  
因公 yīn'gōng  
on duty; on business  
因为 yīn'wèi  
because; for

### 异 yì

① different ② strange; unusual  
③ surprise ④ other; another  
异常 yì'cháng  
unusual; abnormal  
异国 yì'guó  
foreign country  
异议 yì'yì  
objection; dissent

### 译 yì

translate; interpret  
译本 yì'běn  
translation  
译者 yì'zhě  
translator  
译制 yì'zhì  
dub

### 印 yìn

① seal; stamp; chop; print; mark ② print ③ tally; conform  
印花税 yìn'huā'shuì  
stamp duty; stamp tax  
印刷品 yìn'shuā'pǐn  
printed matter  
印象派 yìn'xiàng'pài  
impressionism

### 引 yǐn

① lead; guide ② lure; attract  
③ cause; make ④ quote; cite  
引号 yǐn'hào  
quotation marks  
引进 yǐn'jìn  
import; recommend  
引文 yǐn'wén  
quoted passage

### 饮 yǐn

drink  
饮酒 yǐn'jiǔ  
drink  
饮品 yǐn'pǐn  
drink  
饮用水 yǐn'yòng'shuǐ  
drinking water

### 银 yín

① silver ② silver-coloured  
银屏 yín'píng  
television screen  
银杏 yín'xìng  
ginkgo  
银子 yín'zi  
silver

### 姻 yīn

marriage  
姻亲 yīn'qīn  
relation by marriage  
姻缘 yīn'yuán  
the happy fate which brings  
lovers together

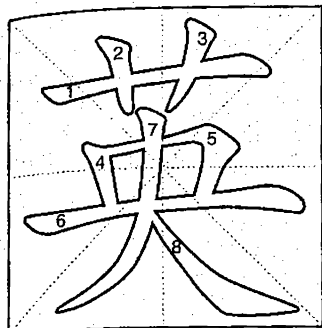

英 yīng 1816

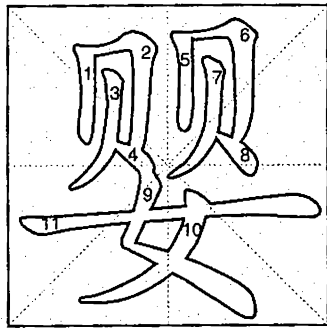

嬰 yīng 1817

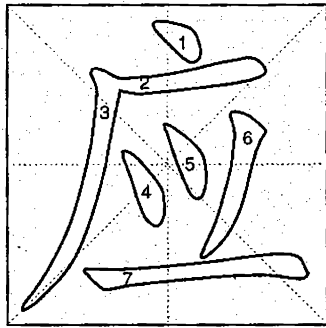

应 yīng 1818

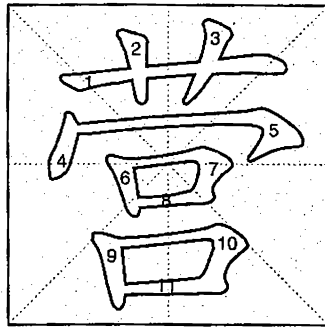

营 yíng 1819

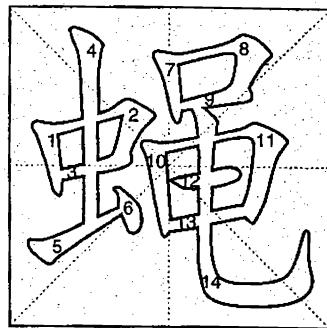

蝇 yíng 1820

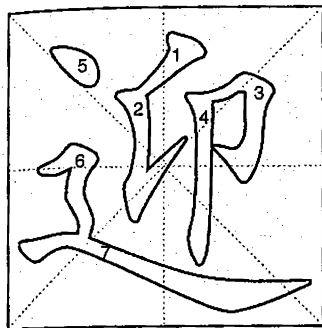

迎 yíng 1821

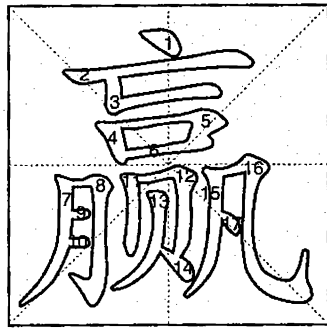

赢 yíng 1822

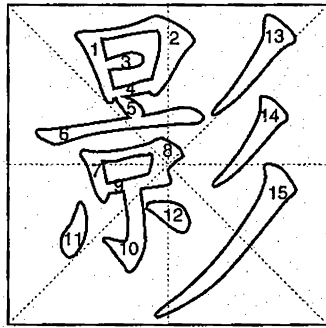

影 yǐng 1823

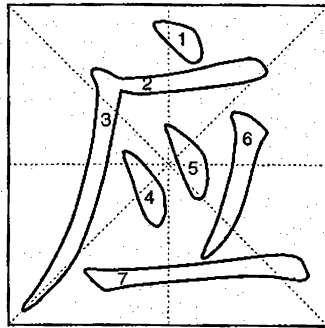

应 yìng 1824

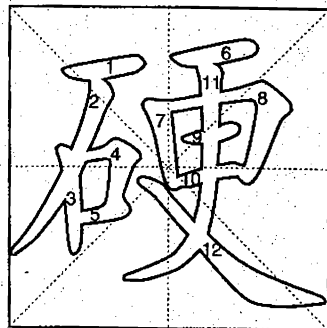

硬 yìng 1825

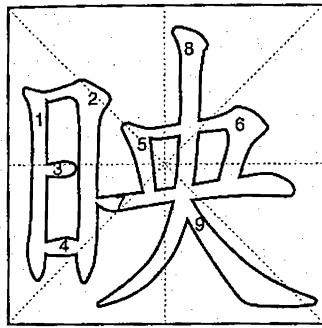

映 yìng 1826

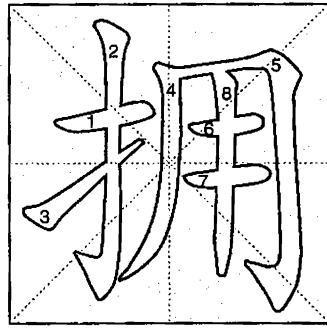

拥 yōng 1827

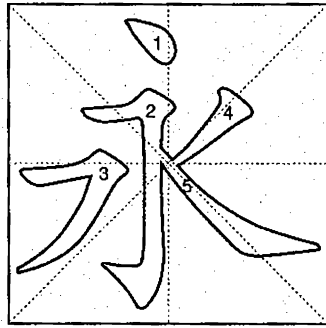

永 yǒng 1828

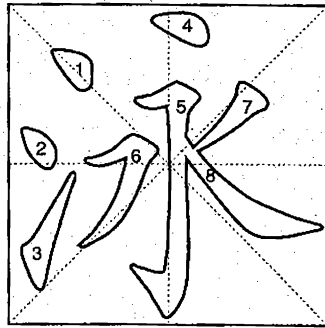

泳 yǒng 1829

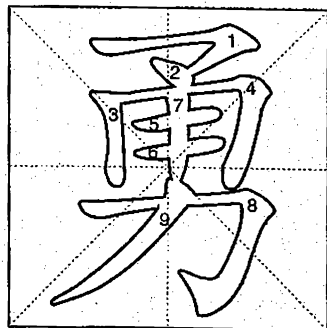

勇 yǒng 1830



### 蝇 yíng

fly  
 蝇卵 yíng'luǎn  
 fly-borne  
 蝇拍 yíng'pāi  
 flyswatter; flyflap  
 蝇头 yíng'tóu  
 fly's head; tiny

### 营 yíng

①seek ②operate; run  
 ③camp; barracks ④battalion  
 营地 yíng'dì  
 campsite  
 营生 yíng'shēng  
 earn a living  
 营业 yíng'yè  
 do business; business

### 应 yīng

①answer; respond ②agree (to do sth.); promise; accept ③should; ought to; must  
 应当 yīng'dāng  
 should; ought to  
 应该 yīng'gāi  
 should; ought to; must  
 应届毕业生 yīng'jiè'bì'yè'shēng  
 graduating students

### 婴 yīng

婴儿 yīng'ér  
 baby; infant  
 婴儿车 yīng'ér'chē  
 perambulator; pram  
 婴儿床 yīng'ér'chuáng  
 cot

### 英 yīng

hero; outstanding person  
 英国 yīng'guó  
 Britain; England  
 英里 yīng'lǐ  
 mile  
 英语 yīng'yǔ  
 English

### 硬 yìng

①hard; stiff; tough  
 ②strong; firm  
 ③manage to do sth. with difficulty  
 ④good (quality); able (person)  
 硬币 yìng'bì  
 coin; specie  
 硬件 yìng'jiàn  
 hardware  
 硬水 yìng'shuǐ  
 hard water

### 应 yìng

①answer; respond ②comply with; grant ③suit; respond to ④deal with; cope with  
 应付 yìng'fù  
 deal with  
 应邀 yìng'yāo  
 at sb.'s invitation  
 应用 yìng'yòng  
 apply; use

### 影 yǐng

①shadow; reflection; image  
 ②photograph; picture  
 ③film; movie  
 影片 yǐng'piàn  
 film; movie; picture  
 影印 yǐng'yìn  
 photo offset process  
 影子 yǐng'zi  
 shadow; reflection

### 赢 yíng

①win; beat ②gain (profit)  
 赢得 yíng'dé  
 gain; win; obtain  
 赢利 yíng'lì  
 profit; gain  
 赢余 yíng'yú  
 surplus; profit

### 迎 yíng

①go to meet; greet; welcome; receive ②move towards; meet face to face  
 迎接 yíng'jiē  
 meet; welcome; greet  
 迎战 yíng'zhàn  
 meet head-on  
 迎着 yíng'zhe  
 in face of; towards

### 勇 yǒng

brave; valiant  
 勇敢 yǒng'gǎn  
 brave; courageous  
 勇气 yǒng'qì  
 courage; nerve  
 勇士 yǒng'shì  
 warrior

### 泳 yǒng

swim  
 泳道 yǒng'dào  
 swimming lane  
 泳帽 yǒng'mào  
 swimming cap  
 泳衣 yǒng'yī  
 swimsuit

### 永 yǒng

perpetually; forever; always  
 永别 yǒng'bié  
 part forever  
 永不 yǒng'bù  
 never  
 永久 yǒng'jiǔ  
 permanent; forever

### 拥 yōng

①hold in one's arms ②gather around ③crowd; throng; swarm  
 ④support ⑤have; possess  
 拥抱 yōng'bào  
 embrace; hug  
 拥护 yōng'hù  
 support; uphold  
 拥挤 yōng'jǐ  
 crowd; push and squeeze

### 映 yìng

reflect; mirror; shine  
 映射 yìng'shè  
 cast light upon  
 映象 yìng'xiàng  
 image  
 映照 yìng'zhào  
 shine upon

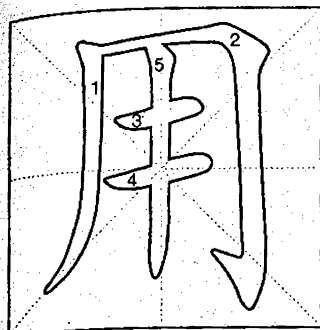

用 yòng 1831

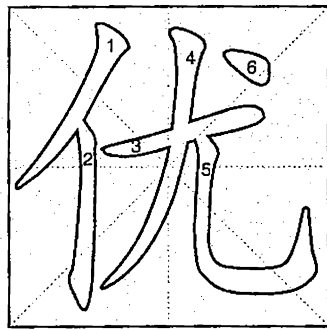

优 yōu 1832

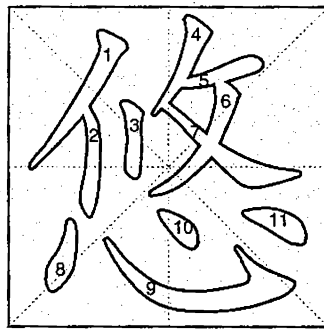

悠 yōu 1833

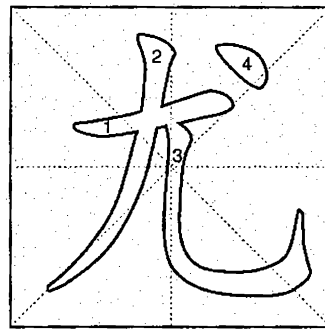

尤 yóu 1834

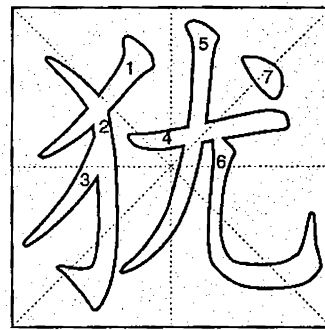

犹 yóu 1835

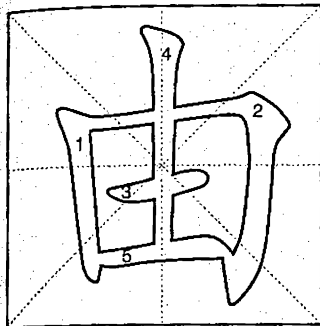

由 yóu 1836

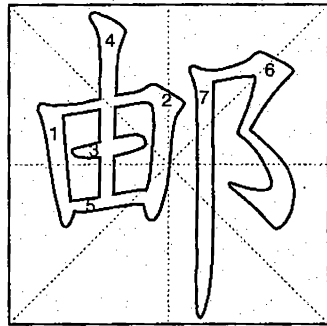

邮 yóu 1837

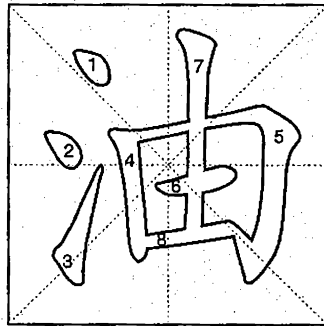

油 yóu 1838

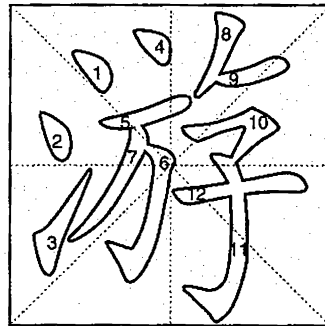

游 yóu 1839

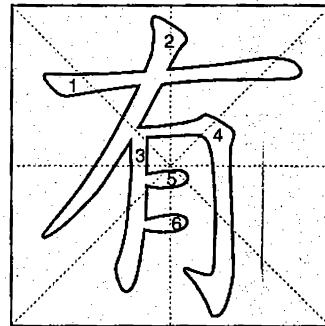

有 yǒu 1840

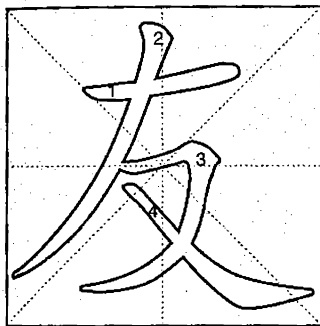

友 yǒu 1841

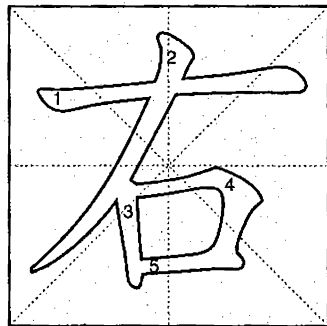

右 yòu 1842

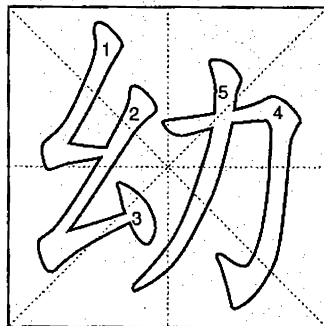

幼 yòu 1843

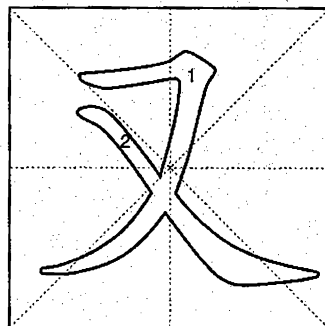

又 yòu 1844

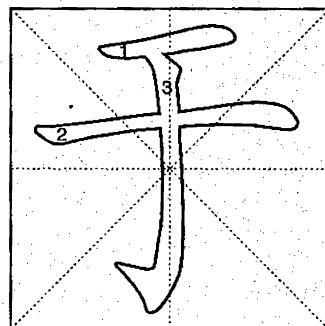

于 yú 1845

### 犹 yóu

①just as; like; as if ②still  
 犹如 yóu'rú  
 as if; just as; like  
 犹疑 yóu'yí  
 hesitate  
 犹豫 yóu'yù  
 hesitate; be irresolute

### 尤 yóu

①outstanding ②fault  
 尤其 yóu'qí  
 especially; particularly

### 悠 yōu

long-drawn-out; remote in time or space; leisurely; swing (across)  
 悠长 yōu'cháng  
 long; long-drawn-out  
 悠久 yōu'jiǔ  
 long; age-old  
 悠闲 yōu'xián  
 leisurely and carefree

### 优 yōu

excellent; fine  
 优等 yōu'děng  
 first-rate; high-class  
 优点 yōu'diǎn  
 merit; advantage  
 优化 yōu'huà  
 optimize

### 用 yòng

①use; employ; apply ②expenses; outlay ③usefulness ④need  
 ⑤eat; drink  
 用法 yòng'fǎ  
 use; usage  
 用功 yòng'gōng  
 diligent; hardworking  
 用户 yòng'hù  
 user; consumer

### 有 yǒu

①have; possess  
 ②there is; exist  
 有病 yǒu'bìng  
 be ill  
 有空 yǒu'kòng  
 be free  
 有时 yǒu'shí  
 sometimes; at times

### 游 yóu

①swim ②wander; travel; tour  
 ③roving; itinerant ④reach  
 游说 yóu'shuì  
 go canvassing  
 游行 yóu'xíng  
 parade; demonstration  
 游泳 yóu'yǒng  
 swim

### 油 yóu

①oil; fat; grease ②apply tung oil or paint ③be stained with oil or grease ④oily; glib  
 油菜 yóu'cài  
 rape  
 油画 yóu'huà  
 oil painting  
 油田 yóu'tián  
 oil field

### 邮 yóu

①post; mail ②postal  
 邮包 yóu'bāo  
 (postal) parcel  
 邮编 yóu'biān  
 zip code; postcode  
 邮购 yóu'gòu  
 mail order

### 由 yóu

①cause; reason ②because of; due to ③through ④follow; obey  
 ⑤by ⑥from  
 由此 yóu'cǐ  
 thus; therefrom  
 由来 yóu'lái  
 origin  
 由于 yóu'yú  
 owing to; because

### 于 yú

①in; at ②for ③to  
 ④from; of  
 于是 yú'shì  
 so; then; as a result

### 又 yòu

①again ②but ③and  
 又及 yòu'jí  
 postscript(ps)  
 又惊又喜 yòu'jīng'yòu'xǐ  
 alarmed and happy at the same time

### 幼 yòu

①young; under age ②children; the young  
 幼儿 yòu'ér  
 child; infant: ~ 园 kindergarten; nursery school  
 幼教 yòu'jiào  
 preschool education  
 幼年 yòu'nián  
 childhood; infancy

### 右 yòu

①the right (side) ②the Right  
 ③west  
 右手 yòu'shǒu  
 the right hand  
 右翼 yòu'yì  
 right wing; the Right  
 右转弯 yòu'zhuǎn wān  
 turn right

### 友 yǒu

①friend ②friendly  
 友邦 yǒu'bāng  
 friendly nation  
 友好 yǒu'hǎo  
 close friend; friendly  
 友好协会 yǒu'hǎo'xié'huì  
 friendship association

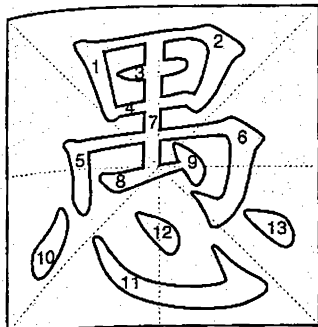

愚 yú 1846

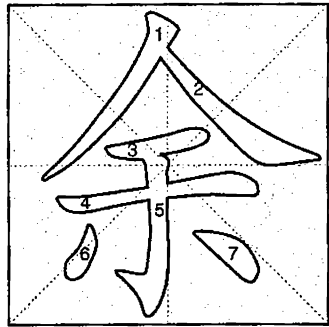

余 yú 1847

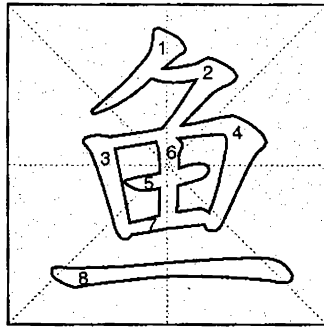

鱼 yú 1848

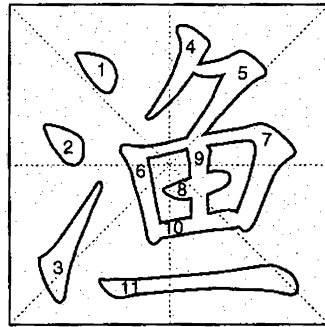

渔 yú 1849

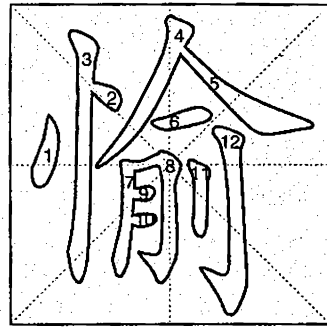

愉 yú 1850

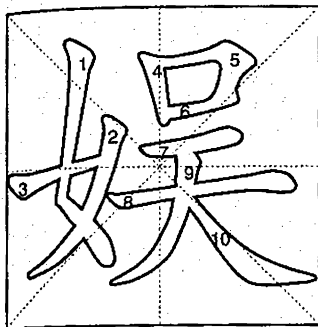

娱 yú 1851

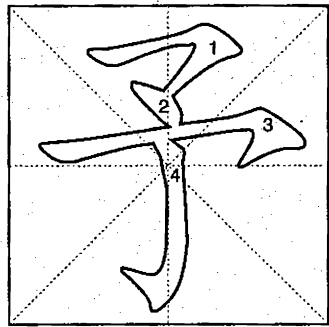

予 yǔ 1852

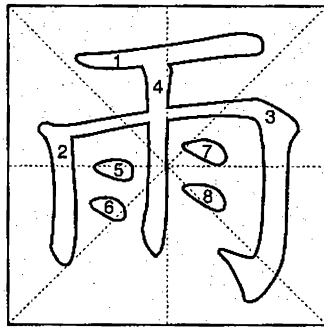

雨 yǔ 1853

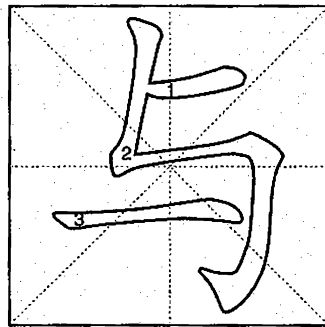

与 yǔ 1854

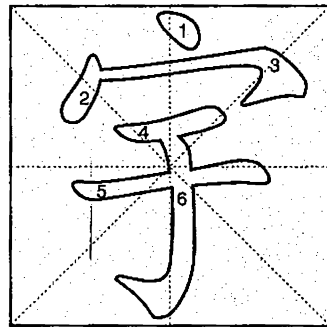

宇 yǔ 1855

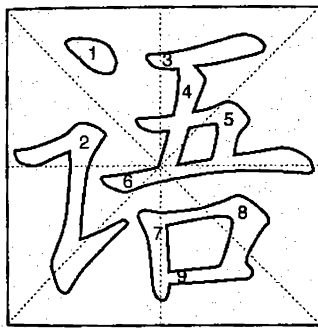

语 yǔ 1856

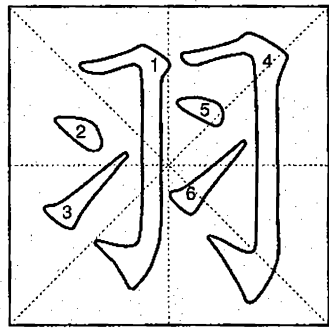

羽 yǔ 1857

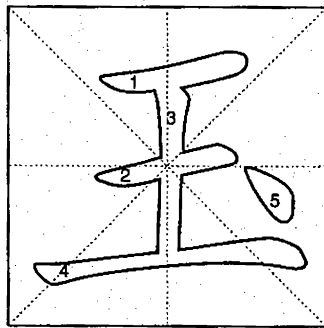

玉 yù 1858

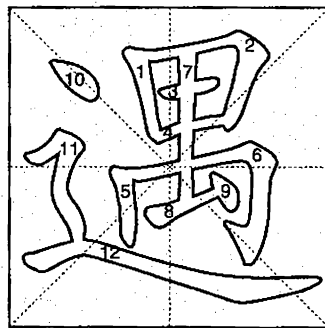

遇 yù 1859

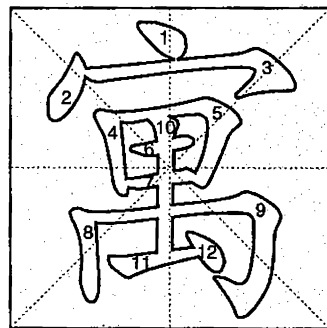

寓 yù 1860

### 愉 yú

pleased; happy  
愉快 yú'kuài  
happy; cheerful; joyful  
愉悦 yú'yùè  
delighted; cheerful

### 渔 yú

fishing  
渔场 yú'chǎng  
fishery  
渔村 yú'cūn  
fishing village  
渔民 yú'mín  
fisherman

### 鱼 yú

fish  
鱼肝油 yú'gān'yóu  
cod-liver oil  
鱼雷 yú'léi  
torpedo  
鱼子酱 yú'zǐ'jiàng  
caviare

### 余 yú

①surplus; spare; remaining  
②more than; odd; over  
③beyond; after  
余存 yú'cún  
remainder; balance  
余毒 yú'dú  
residual poison  
余力 yú'lì  
surplus energy

### 愚 yú

①stupid; foolish ②make a fool of  
愚笨 yú'bèn  
stupid; foolish; clumsy  
愚昧 yú'mèi  
ignorant; benighted  
愚人节 yú'rén'jié  
April Fools' Day

### 宇 yǔ

①eaves ②house ③space; universe; world  
宇航 yǔ'háng  
space flight; astronautic  
宇宙 yǔ'zhòu  
universe; cosmos  
宇宙飞船 yǔ'zhòu'fēi'chuán  
spaceship; spacecraft

### 与 yǔ

①give; offer; grant ②help; support ③to ④and  
与此相反 yǔ'cǐ'xiāng'fǎn  
contrariwise  
人为善 yǔ'rén'wéi'shàn  
well-intentioned  
与众不同 yǔ'zhòng'bù'tóng  
out of the ordinary

### 雨 yǔ

rain  
雨伞 yǔ'sǎn  
umbrella  
雨鞋 yǔ'xié  
rubber boots; rubbers  
雨衣 yǔ'yī  
raincoat; waterproof

### 予 yǔ

give; grant; bestow  
予人口实 yǔ'rén'kǒu'shí  
give cause for gossip  
予以 yǔ'yǐ  
grant; give

### 娱 yú

①give pleasure to; amuse  
②joy  
娱乐 yú'lè  
amusement; recreation  
娱乐圈 yú'lè'quān  
entertainment world

### 寓 yù

①reside; live ②residence; abode  
③imply; contain  
寓居 yù'jū  
live  
寓所 yù'suǒ  
residence; abode  
寓言 yù'yán  
fable; allegory; parable

### 遇 yù

①meet ②treat; receive  
③chance; opportunity  
遇刺 yù'cì  
be attacked by an assassin  
遇见 yù'jiàn  
meet; come across  
遇难 yù'nàn  
die in an accident

### 玉 yù

jade  
玉雕 yù'diāo  
jade carving  
玉米 yù'mǐ  
maize; corn  
玉石 yù'shí  
jade

### 羽 yǔ

feather  
羽毛 yǔ'máo  
feather; plume  
羽毛球 yǔ'máo'qiú  
badminton; shuttlecock  
羽绒 yǔ'róng  
eiderdown

### 语 yǔ

①language; tongue; words  
②speak; say ③set phrase; proverb  
④sign; signal  
语法 yǔ'fǎ  
grammar  
语汇 yǔ'huì  
vocabulary  
语句 yǔ'jù  
sentence

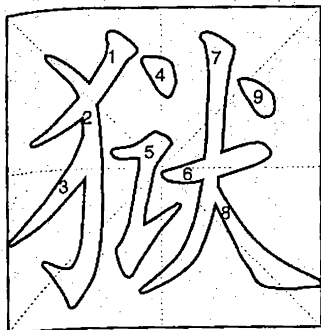

狱 yù 1861



育 yù 1862

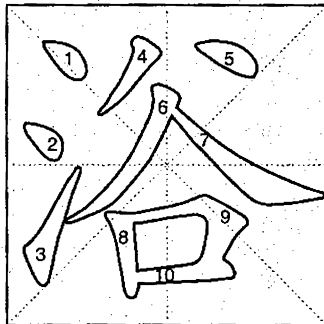

浴 yù 1863

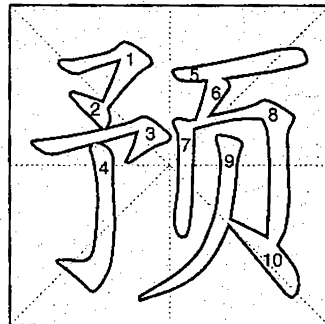

预 yù 1864

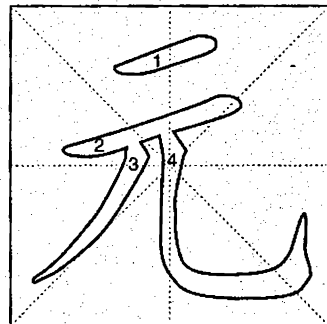

元 yuán 1865

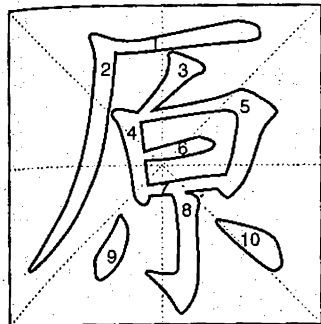

原 yuán 1866

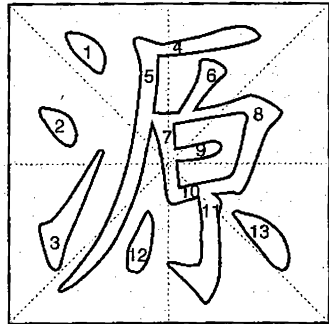

源 yuán 1867



缘 yuán 1868

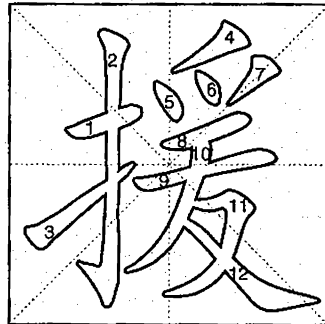

援 yuán 1869

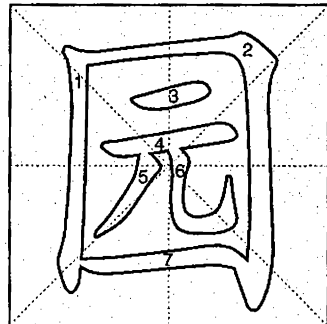

园 yuán 1870

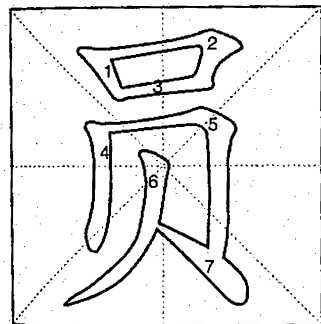

员 yuán 1871

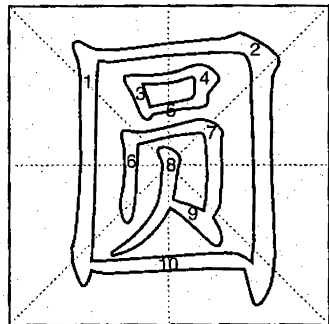

圆 yuán 1872

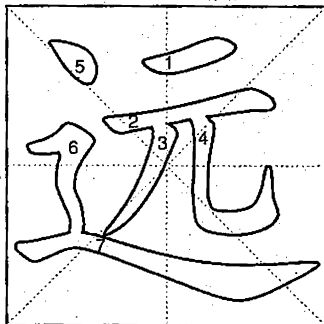

远 yuǎn 1873

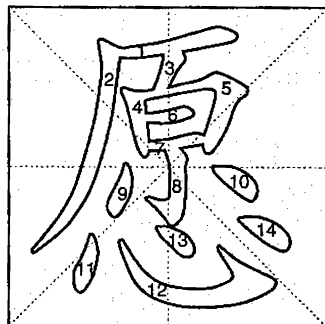

愿 yuàn 1874

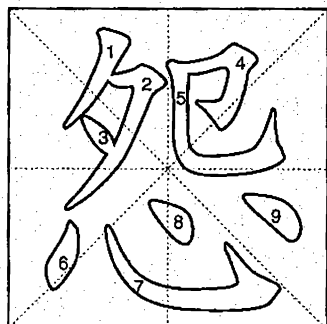

怨 yuàn 1875

### 元 yuán

①first; primary ②unit; component  
元旦 yuán'dàn  
New Year's Day  
元老 yuán'lǎo  
senior statesman  
元月 yuán'yuè  
January

### 预 yù

in advance; beforehand  
预报 yù'bào  
forecast  
预订 yù'dìng  
subscribe; book  
预付 yù'fù  
pay in advance

### 浴 yù

bath; bathe  
浴场 yù'chǎng  
outdoor bathing place; bathing  
beach  
浴巾 yù'jīn  
bath towel  
浴盆 yù'pén  
bath tub

### 育 yù

①give birth to ②rear; raise;  
bring up ③educate  
育龄 yù'líng  
child-bearing age  
育苗〈农〉 yù'miáo〈nóng〉  
grow seedlings  
育种〈农〉 yù'zhǒng〈nóng〉  
breeding

### 狱 yù

①prison; jail ②lawsuit; case  
狱警 yù'jǐng  
jailer; gaoler

### 园 yuán

①an area of land for growing  
plants ②a place for public recre-  
ation  
公园 gōng'yuan  
park

### 援 yuán

①help; aid ②cite; quote  
援兵 yuán'bīng  
relief troops  
援外 yuán'wài  
foreign aid  
援助 yuán'zhù  
help; assist; support

### 缘 yuán

①reason  
②edge; fringe; brink  
缘何 yuán'hé  
why  
缘起 yuán'qǐ  
genesis; origin  
缘由 yuán'yóu  
reason; cause

### 源 yuán

source  
源代码 yuán'dài'mǎ  
source code  
源泉 yuán'quán  
source; fountainhead  
源源 yuán'yuán  
continuously

### 原 yuán

①primary; original; former  
②raw ③excuse; pardon ④open  
country  
原版 yuán'bǎn  
original edition  
原因 yuán'yīn  
cause; reason  
原子 yuán'zǐ  
atom; ~弹 atom bomb

### 怨 yuàn

①resentment ②blame; complain  
怨恨 yuàn'hèn  
hate; resentment  
怨气 yuàn'qì  
grievance; complaint  
怨言 yuàn'yán  
grumble; complaint

### 愿 yuàn

①hope; wish; desire ②be willing  
③vow  
愿望 yuàn'wàng  
desire; wish; aspiration  
愿意 yuàn'yì  
be willing; wish

### 远 yuǎn

far; distant; remote  
远东 yuǎn'dōng  
the Far East  
远郊 yuǎn'jiāo  
outer suburbs  
远洋 yuǎn'yáng  
ocean; oceanic

### 圆 yuán

①round; circular; spherical  
hole ②circle ③justify ④yuan, the  
monetary unit of China  
圆形 yuán'xíng  
circular; round  
圆柱 yuán'zhù  
cylinder  
圆桌 yuán'zhuō  
round table

### 员 yuán

①a person engaged in some field  
of activity ②member  
员额 yuán'é  
personnel quota  
员工 yuán'gōng  
staff; personnel

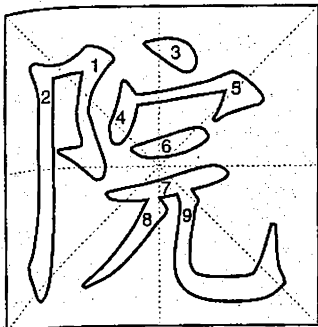

院 yuàn 1876

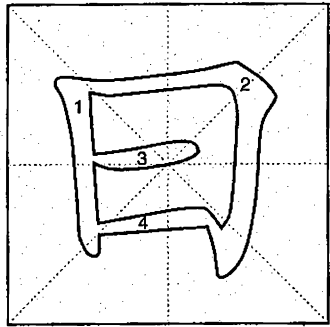

曰 yuē 1877

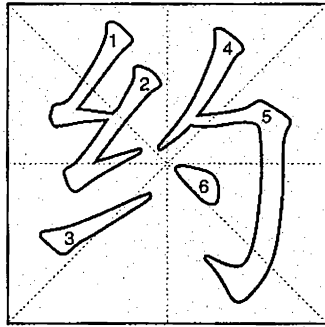

约 yuē 1878

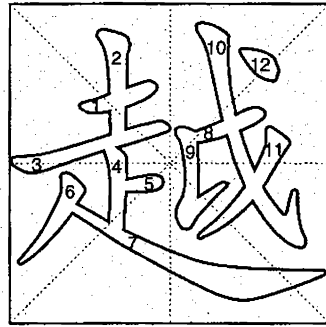

越 yuè 1879

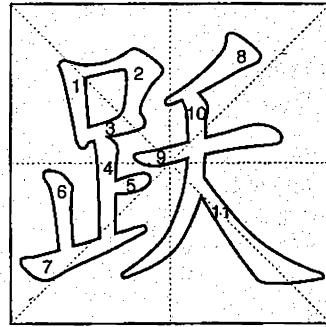

跃 yuè 1880

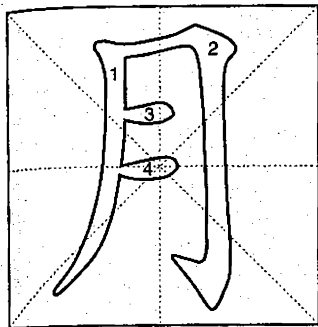

月 yuè 1881

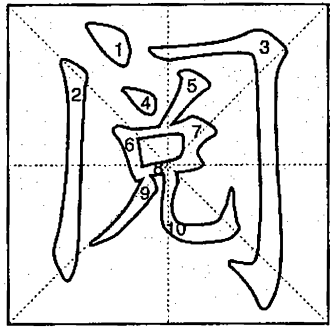

阅 yuè 1882

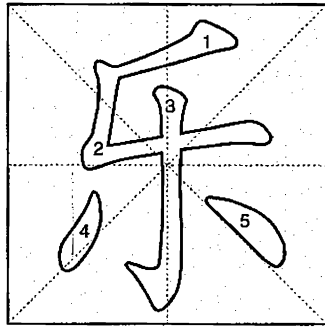

乐 yuè 1883

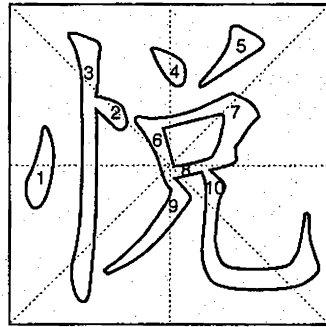

悦 yuè 1884

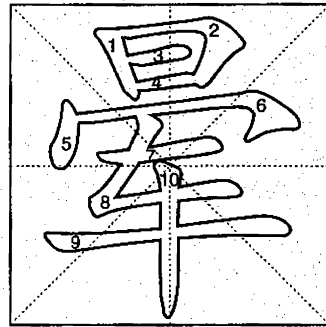

晕 yūn 1885

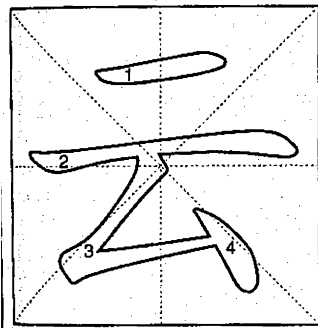

云 yún 1886

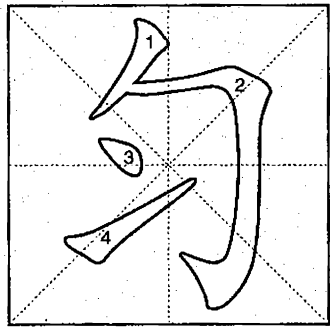

匀 yún 1887

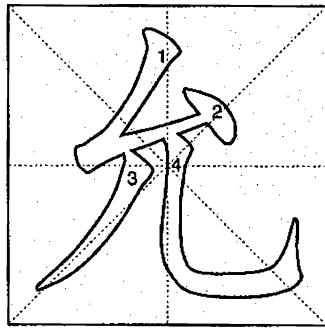

允 yǔn 1888

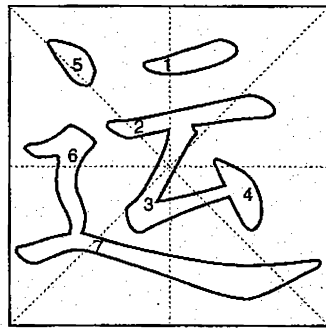

运 yùn 1889

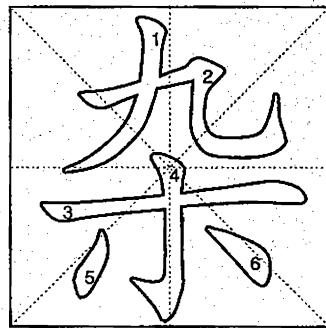

杂 zá 1890



### 跃 yuè

leap; jump  
 跃然 yuè'rán  
 appear vividly  
 跃升 yuè'shēng  
 jump; rise by leaps  
 跃跃欲试 yuè'yùè'yù'shì  
 itch to have a go

### 越 yuè

①get over; jump over ②exceed; overstep ③the more..., the more...  
 越境 yuè'jìng  
 cross the boundary illegally  
 越位(体) yuè'wèi(tǐ)  
 offside  
 越狱 yuè'yù  
 escape from prison

### 约 yuē

①make an appointment (with sb.); arrange ②ask or invite in advance ③pact; agreement  
 约定 yuē'dìng  
 agree on; arrange  
 约会 yuē'huì  
 appointment; date  
 约请 yuē'qǐng  
 invite; ask

### 曰 yuē

①say ②call; name

### 院 yuàn

①courtyard; yard ②a designation for certain government offices and public places  
 院落 yuàn'luò  
 courtyard; yard  
 院士 yuàn'shì  
 academician  
 院子 yuàn'zi  
 courtyard; yard

### 晕 yūn

①dizzy; giddy ②swoon; faint  
 晕倒 yūn'dǎo  
 fall in a faint; pass out  
 晕头转向 yūn'tóu'zhuǎn'xiàng  
 confused and disoriented

### 悦 yuè

①happy; pleased; delighted ②please; delight  
 悦耳 yuè'ěr  
 sweetsounding  
 悦服 yuè'fú  
 heartily admire  
 悦目 yuè'mù  
 good-looking

### 乐 yuè

music  
 乐池 yuè'chí  
 orchestra pit  
 乐曲 yuè'qǔ  
 musical composition  
 乐团 yuè'tuán  
 philharmonic orchestra

### 阅 yuè

①read; go over ②review; inspect  
 阅兵 yuè'bīng  
 review troops  
 阅读 yuè'dú  
 read  
 阅历 yuè'lì  
 experience

### 月 yuè

①the moon ②month  
 月份 yuè'fēn  
 month  
 月亮 yuè'liang  
 the moon  
 月台 yuè'tái  
 railway platform

### 杂 zá

①sundry; mixed ②mix; mingle  
 杂草 zá'cǎo  
 weeds  
 杂技 zá'jì  
 acrobatics  
 杂志 zá'zhì  
 magazine

### 运 yùn

①carry; transport ②use; wield; utilize ③fortune; fate  
 运动会 yùn'dòng'huì  
 sports meet; games  
 运费 yùn'fèi  
 freight  
 运河 yùn'hé  
 canal

### 允 yǔn

①permit; allow ②fair; just  
 允诺 yǔn'nuò  
 promise; consent  
 允许 yǔn'xǔ  
 permit; allow

### 匀 yún

①even ②even up; divide evenly ③spare  
 匀称 yún'chèn  
 well-proportioned  
 匀速运动(物)  
 yún'sù'yùn'dòng(wù)  
 uniform motion

### 云 yún

①say ②cloud  
 云层 yún'céng  
 cloud layer  
 云集 yún'jí  
 gather; converge  
 云梯 yún'tī  
 scaling ladder

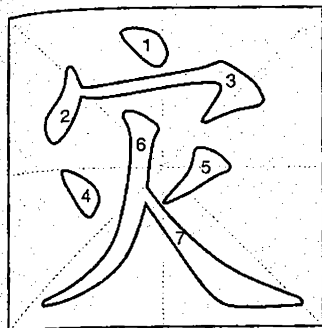

灾 zāi 1891

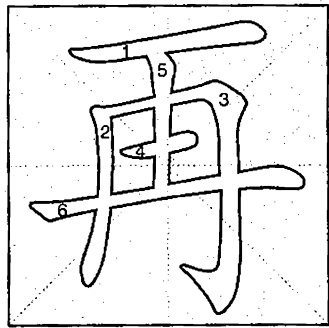

再 zài 1892

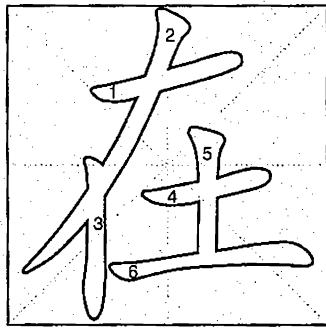

在 zài 1893

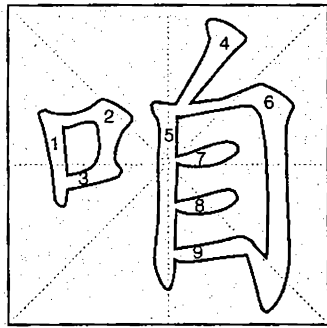

咱 zán 1894

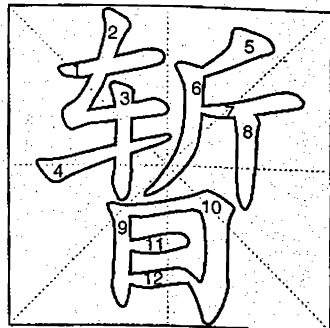

暂 zàn 1895

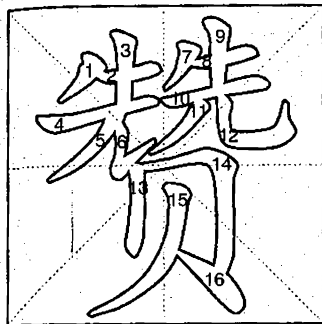

赞 zàn 1896

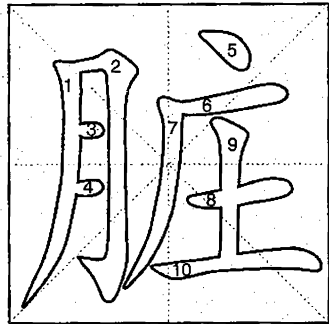

脏 zāng 1897

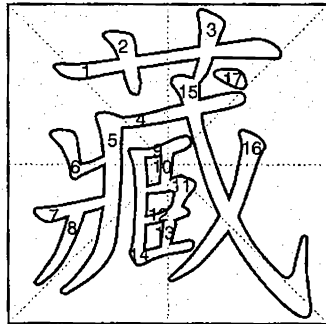

藏 zàng 1898

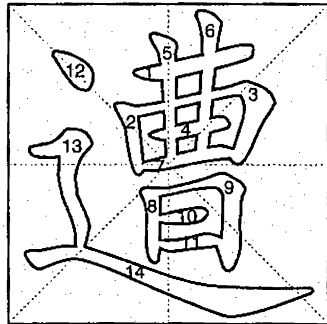

遭 zāo 1899

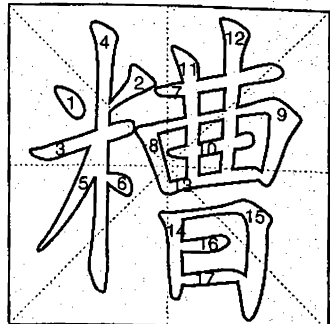

糟 zāo 1900

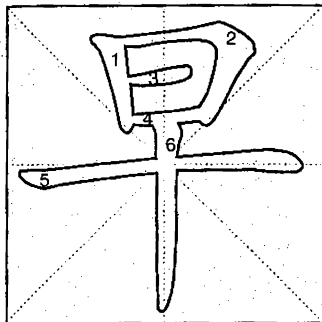

早 zǎo 1901

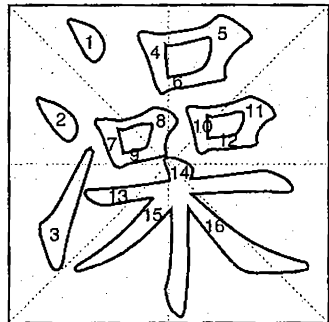

燥 zǎo 1902

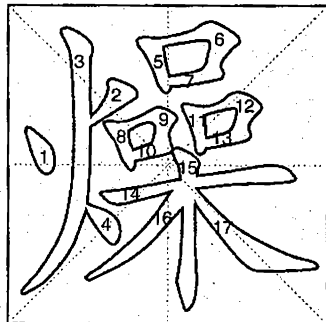

燥 zào 1903

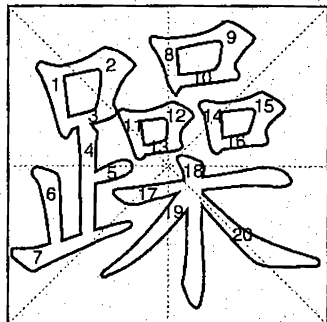

躁 zào 1904

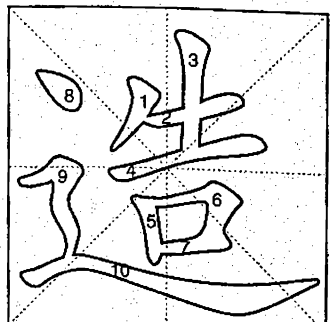

造 zào 1905

### 暂 zàn

①of short duration ②for the time being; for the moment  
 暂时 zàn'shí  
 temporary; transient  
 暂停 zàn'tíng  
 suspend  
 暂住 zàn'zhù  
 stay temporarily

### 咱 zán

we  
 咱们 zán'men  
 we

### 在 zài

①exist; be living ②be ③at; in  
 ④rest with; depend on  
 在行 zài'háng  
 be expert at  
 在即 zài'jí  
 very soon  
 在家 zài'jiā  
 be at home; be in

### 再 zài

①another time; again; once more  
 ②come back; return  
 再版 zài'bǎn  
 second edition; reprint  
 再见 zài'jiàn  
 good-bye; see you again  
 再现 zài'xiàn  
 reappear

### 灾 zāi

①calamity  
 ②personal misfortune; adversity  
 灾害 zāi'hài  
 disaster  
 灾民 zāi'mín  
 victims of a natural calamity  
 灾区 zāi'qū  
 afflicted area

### 糟 zāo

①(distillers) grains ②be pickled with grains or in wine ③rotten; poor ④in a terrible state; in a mess  
 糟糕 zāo'gāo  
 terrible; too bad  
 糟粕 zāo'pè  
 waste matter; dross  
 糟蹋 zāo'tà  
 waste; insult; violate

### 遭 zāo

suffer  
 遭到 zāo'dào  
 meet with; suffer  
 遭受 zāo'shòu  
 suffer; sustain  
 遭灾 zāo'zāi  
 be hit by a natural calamity

### 藏 zàng

storing place; depository  
 藏蓝 zàng'lán  
 purplish blue  
 藏青 zàng'qīng  
 dark blue  
 藏医 zàng'yī  
 Tibetan medicine

### 脏 zāng

dirty; filthy  
 脏话 zāng'huà  
 dirty words  
 脏土 zāng'tǔ  
 dust; garbage  
 脏字 zāng'zì  
 obscene word

### 赞 zàn

①support; favour ②praise; commend  
 赞成 zàn'chéng  
 approve of; favour  
 赞美 zàn'měi  
 eulogize; extol  
 赞助 zàn'zhù  
 support; assistance

### 造 zào

①make; build; create ②invent  
 ③train; educate  
 造反 zào'fǎn  
 rebel; revolt  
 造价 zào'jià  
 cost of building  
 造谣 zào'yáo  
 tell lies; start rumours

### 躁 zào

rash; impetuous  
 躁动 zào'dòng  
 move restlessly

### 燥 zào

dry  
 燥热 zào'rè  
 hot and dry

### 澡 zǎo

bath  
 澡盆 zǎo'pén  
 bathtub  
 澡堂 zǎo'táng  
 bathhouse

### 早 zǎo

①(early) morning ②long ago; for a long time ③early; beforehand  
 ④good morning  
 早安 zǎo'ān  
 good morning  
 早班 zǎo'bān  
 morning shift  
 早餐 zǎo'cān  
 breakfast

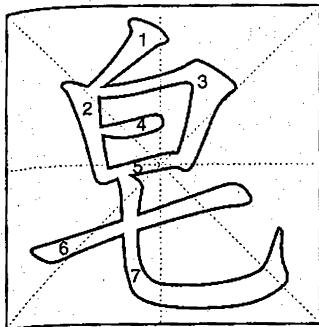

皂 zào 1906



贲 bì 1907

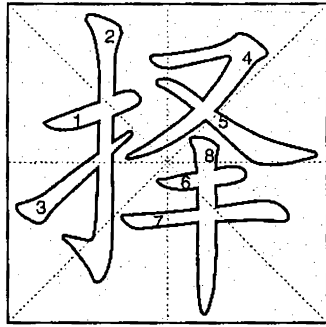

择 zé 1908

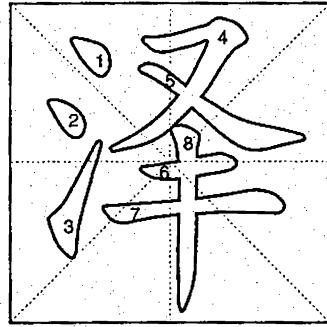

泽 zé 1909

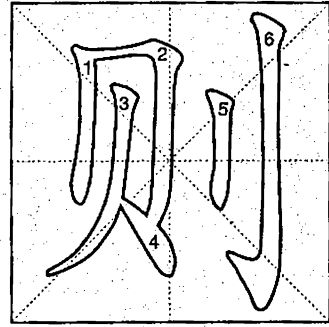

则 zé 1910

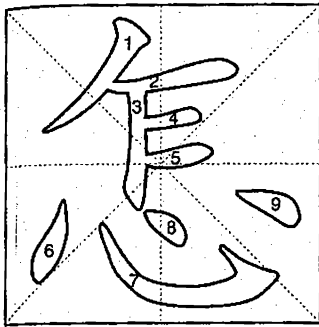

怎 zěn 1911

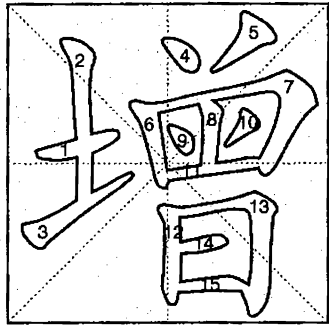

增 zēng 1912

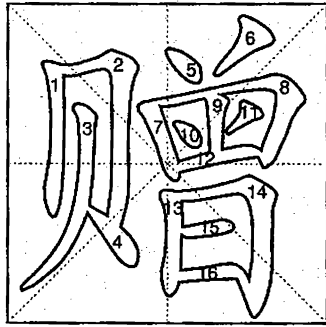

赠 zèng 1913

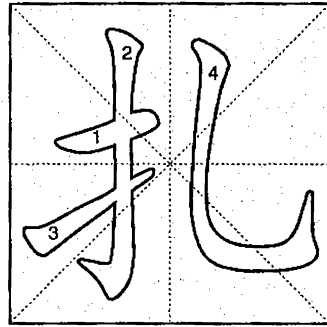

扎 zhā 1914

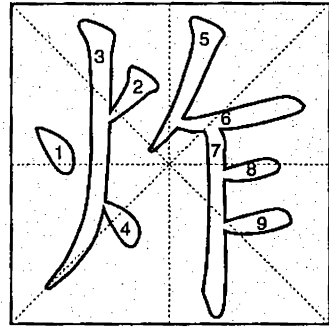

炸 zhá 1915

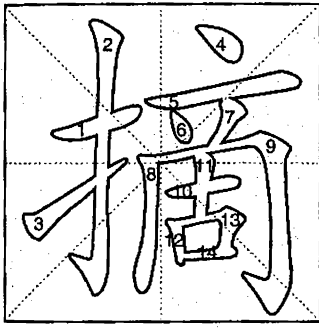

摘 zhāi 1916

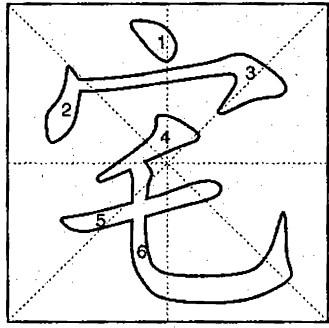

宅 zhái 1917

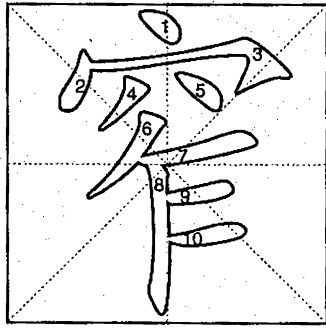

窄 zhǎi 1918

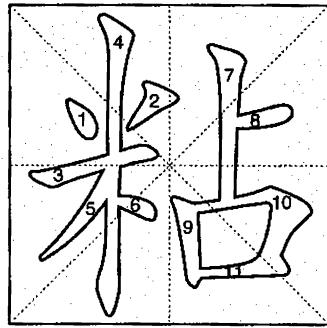

粘 zhān 1919

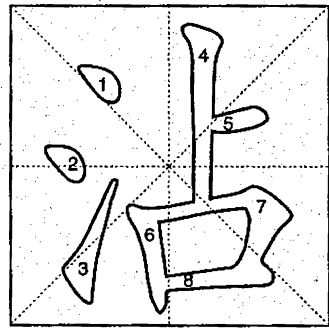

沾 zhān 1920

### 则 zé

- ①standard; norm; criterion  
 ②rule; regulation  
 原则 yuán'zé  
 principle

### 泽 zé

- ①pool; pond ②damp; moist  
 ③lustre(of metals, pearls, etc.)  
 沼泽 zhǎo'zé  
 marsh; swamp; bog

### 择 zé

- select; choose; pick  
 择期 zé'qī  
 select a day  
 择业 zé'yè  
 job selection  
 择友 zé'yǒu  
 choose friends

### 责 zé

- ①duty ②demand; require  
 ③question closely ④reproach; re-  
 buke; blame ⑤punish  
 责备 zé'bèi  
 reproach; blame  
 责令 zé'lìng  
 instruct; order  
 责任 zé'rèn  
 duty; responsibility; obligation

### 皂 zào

- ①black ②soap 香-toilet soap  
 药~ medicated soap  
 皂白 zào'bái  
 black and white  
 皂片 zào'piàn  
 soap chips; soap flakes

### 炸 zhá

- deep-fry  
 炸鸡 zhā'jī  
 fried chicken  
 炸酱 zhā'jiàng  
 fried bean sauce  
 炸鱼 zhā'yú  
 deep-fried fish

### 扎 zhā

- ①prick; run or stick (a needle,  
 etc.) into ②plunge into; get into  
 ③encamp  
 扎啤 zhā'pí  
 draft beer; jar beer  
 扎营 zhā'yíng  
 encamp  
 扎针 zhā'zhēn  
 give or have an acupuncture  
 treatment

### 赠 zèng

- give as a present  
 赠款 zèng'kuǎn  
 grant  
 赠券 zèng'quàn  
 gift coupon  
 赠阅 zèng'yue  
 given free by publisher

### 增 zēng

- increase; gain; add  
 增加 zēng'jiā  
 increase; raise; add  
 增刊 zēng'kān  
 supplementary issue  
 增收 zēng'shōu  
 increase income

### 怎 zěn

- why; how  
 怎么 zěn'me  
 what; why; how  
 怎么样 zěn'me'yàng  
 what; how  
 怎能 zěn'néng  
 how can; how could

### 沾 zhān

- ①be stained with ②touch  
 沾光 zhān'guāng  
 benefit from association with sb.  
 or sth.  
 沾染 zhān'rǎn  
 be infected with  
 沾沾自喜 zhān'zhān'zì'xǐ  
 feel smug

### 粘 zhān

- glue; stick; paste  
 粘剂 zhān'jì  
 adhesive  
 粘连 zhān'lián  
 adhesion  
 粘贴 zhān'tiē  
 paste; stick

### 窄 zhǎi

- ①narrow ②petty  
 窄道 zhǎi'dào  
 narrow path

### 宅 zhái

- residence; house  
 宅基 zhái'jī  
 ground; foundation  
 宅门 zhái'mén  
 gate of a big house  
 宅院 zhái'yuàn  
 a house with a courtyard

### 摘 zhāi

- ①pick; pluck; take off  
 ②select; make extracts from  
 摘除 zhāi'chú  
 excise; remove  
 摘掉 zhāi'diào  
 take off  
 摘要 zhāi'yào  
 make a summary  
 摘引 zhāi'yǐn  
 quote

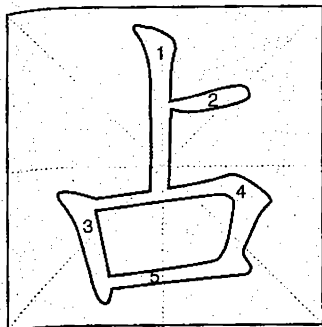

占 zhān 1921

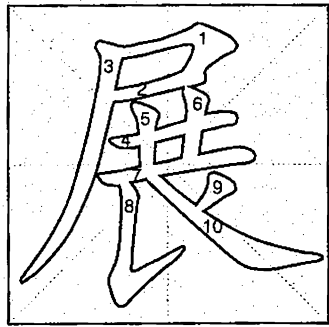

展 zhǎn 1922



战 zhàn 1923

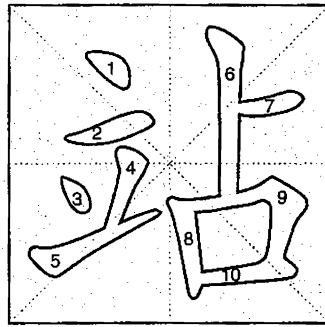

站 zhàn 1924

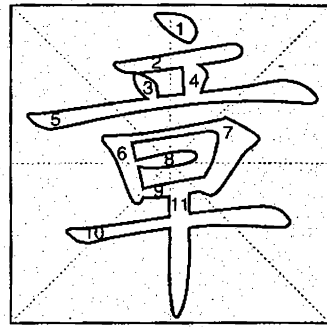

章 zhāng 1925

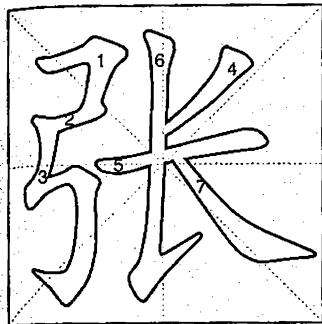

张 zhāng 1926

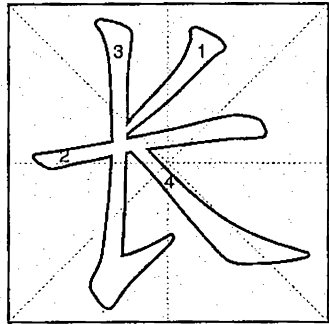

长 zhǎng 1927

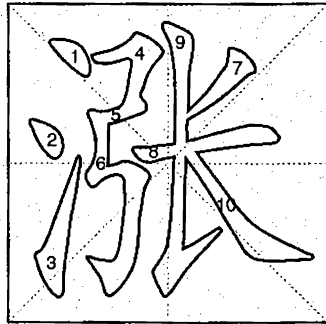

涨 zhǎng 1928

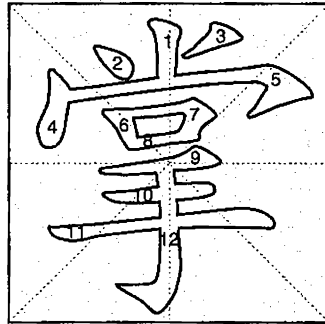

掌 zhǎng 1929

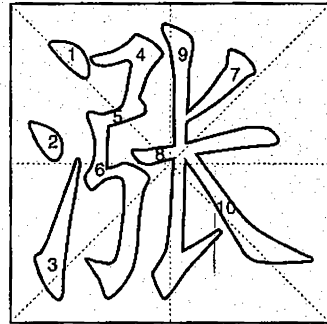

涨 zhàng 1930

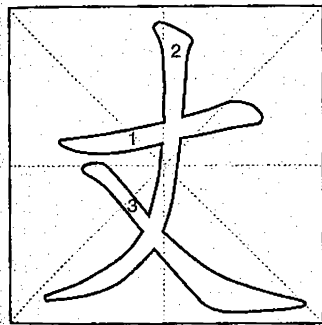

丈 zhàng 1931

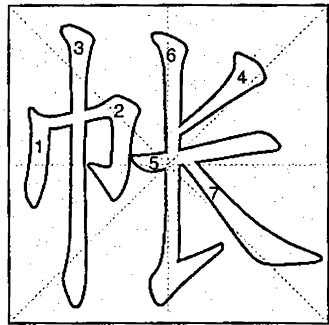

帐 zhàng 1932

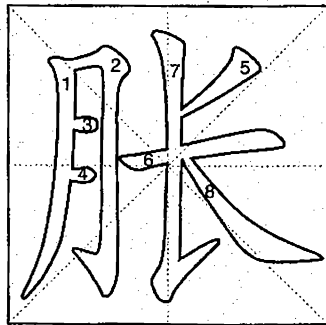

胀 zhàng 1933

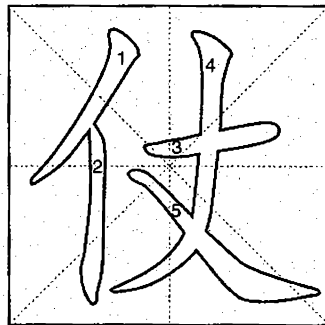

仗 zhàng 1934

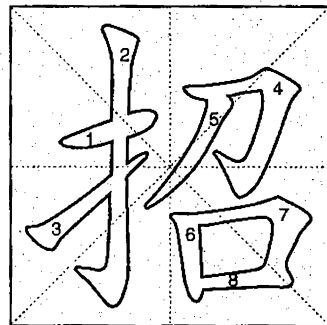

招 zhāo 1935

### 章 zhāng

- ①chapter; section ②order  
 ③rules; regulations ④seal; stamp  
 ⑤badge; medal  
 章程 zhāng'chéng  
 rules; regulations  
 章法 zhāng'fǎ  
 orderly  
 章节 zhāng'jié  
 chapters and sections

### 站 zhàn

- ①stand ②stop ③station  
 ④centre  
 站岗 zhàn'gǎng  
 stand guard  
 站票 zhàn'piào  
 ticket without seat  
 站台 zhàn'tái  
 platform

### 战 zhàn

- ①war; warfare; battle ②fight  
 战士 zhàn'shì  
 soldier  
 战友 zhàn'yǒu  
 comrade-in-arms  
 战争 zhàn'zhēng  
 war; warfare

### 展 zhǎn

- ①open up; spread out; unfold;  
 unfurl ②put to good use; give free  
 play to ③postpone; prolong ④ex-  
 hibition  
 展播 zhǎn'bō  
 show broadcast  
 展览会 zhǎn'lǎn'huì  
 exhibition  
 展厅 zhǎn'tīng  
 exhibition hall

### 占 zhān

- practise divination  
 占卜 zhān'bǔ  
 practise divination  
 占卦 zhān'guà  
 divination

### 涨 zhàng

- ①swell after absorbing water, etc.  
 ②be swelled by a rush of blood  
 膨胀 péng'zhàng  
 expand; swell; dilate; inflate

### 掌 zhǎng

- ①palm ②strike with the palm of  
 the hand ③be in charge of; control  
 ④pad ⑤shoe sole or heel  
 掌管 zhǎng'guǎn  
 be in charge of  
 掌柜 zhǎng'guì  
 shopkeeper; manager  
 掌权 zhǎng'quán  
 be in power (the saddle)

### 涨 zhǎng

- (of water, etc.) rise; go up  
 涨潮 zhǎng'cháo  
 rising tide; flood tide  
 涨价 zhǎng'jià  
 rise in price  
 涨落 zhǎng'lùò  
 rise and fall; fluctuate

### 长 zhǎng

- ①older; elder; senior ②eldest;  
 oldest ③chief; head ④grow; de-  
 velop  
 长见识 zhǎng'jiàn'shì  
 increase knowledge  
 长进 zhǎng'jìn  
 progress  
 长子 zhǎng'zǐ  
 eldest son

### 张 zhāng

- ①open; spread; stretch ②set  
 out; display ③look  
 张开 zhāng'kāi  
 open; stretch; spread  
 张目 zhāng'mù  
 open one's eyes wide  
 张贴 zhāng'tiē  
 put up

### 招 zhāo

- ①beckon ②recruit; enlist; enrol  
 ③attract; incur; court ④provoke;  
 tease ⑤confess; own up  
 招标 zhāo'biāo  
 invite bids  
 招呼 zhāo'hu  
 call; hail; say hello to  
 招生 zhāo'shēng  
 enrol new students

### 仗 zhàng

- ①weapon; weapons ②hold (a  
 weapon) ③depend on ④battle; war  
 仗势欺人 zhàng'shì'qī'rén  
 take advantage of one's or sb.  
 else's power to bully people

### 胀 zhàng

- ①expand; distend ②swell  
 肿胀 zhǒng'zhàng  
 swelling

### 帐 zhàng

- ①curtain; canopy ②account  
 ③debt; credit  
 帐本 zhàng'běn  
 account book  
 帐单 zhàng'dān  
 bill; check  
 帐户 zhàng'hù  
 account

### 丈 zhàng

- zhàng, a unit of length (=3.33  
 metres)  
 丈夫 zhàng'fu  
 husband  
 丈母娘 zhàng'mǔ'niáng  
 wife's mother  
 丈人 zhàng'ren  
 wife's father

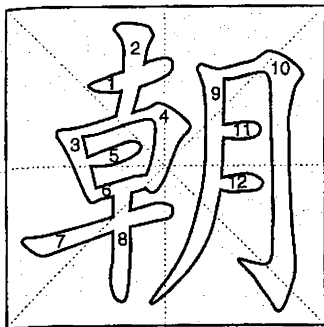

朝 zhāo 1936

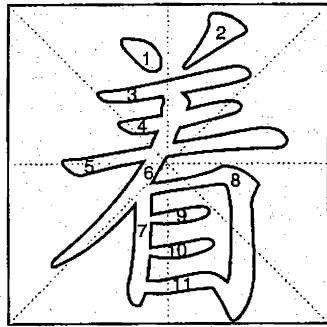

着 zháo 1937

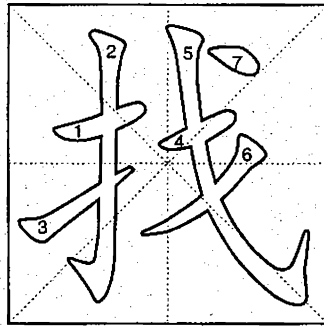

找 zhǎo 1938

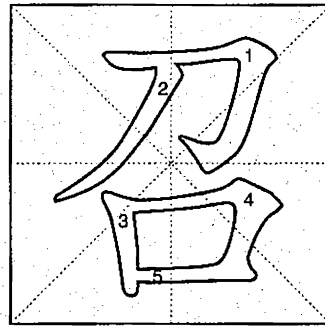

召 zhào 1939

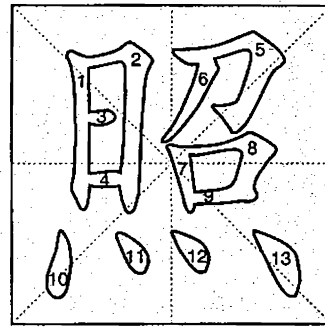

照 zhào 1940

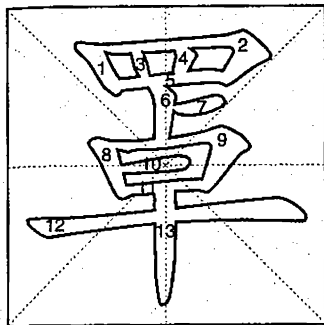

罩 zhào 1941

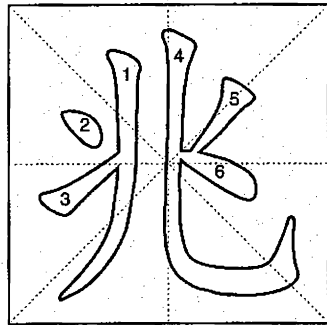

兆 zhào 1942

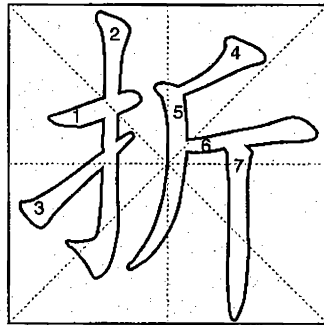

折 zhé 1943

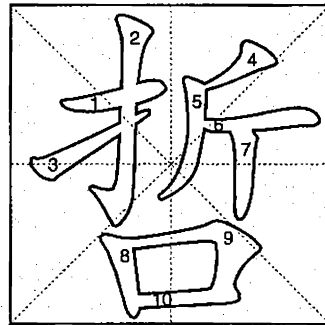

哲 zhé 1944

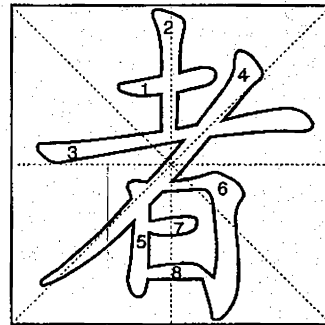

者 zhě 1945

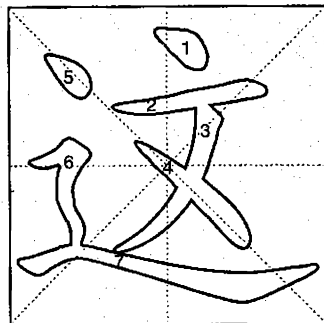

这 zhè 1946

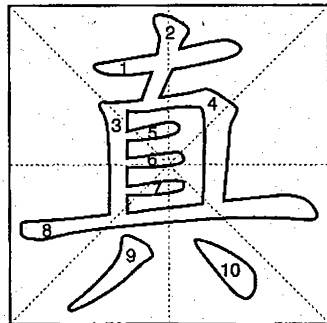

真 zhēn 1947

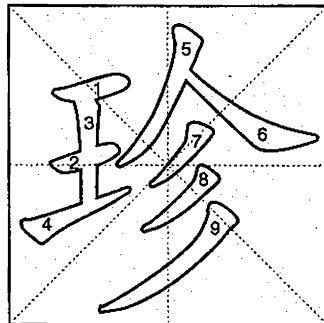

珍 zhēn 1948

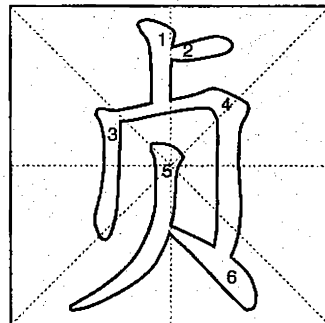

贞 zhēn 1949

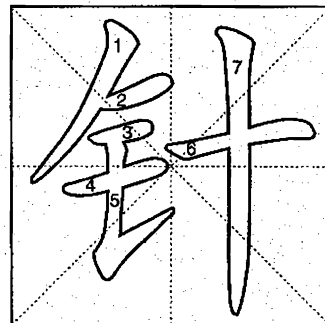

针 zhēn 1950



### 照 zhào

- ① shine; illuminate; light (up)  
 ② take a picture; photograph; film; shoot ③ reflect; mirror ④ picture  
 ⑤ license; permit  
 照常 zhào'cháng  
 as usual  
 照看 zhào'kàn  
 look after; attend to  
 照片 zhào'piàn  
 photograph; picture

### 召 zhào

- convene  
 召唤 zhào'huàn  
 call; summon  
 召回 zhào'huī  
 recall  
 召开 zhào'kāi  
 convoke (a conference)

### 找 zhǎo

- ① look for; try to find; seek  
 ② want to see; call on; approach;  
 ask for ③ give change  
 找工作 zhǎo'gōng'zuò  
 look for a job  
 找钱 zhǎo'qián  
 give change  
 找寻 zhǎo'xún  
 look for; seek

### 着 zháo

- ① touch ② feel; be affected by  
 (cold, etc.) ③ burn ④ fall asleep  
 着火 zháo'huǒ  
 catch (or take) fire  
 着急 zháo'jí  
 feel worried; be anxious  
 着忙 zháo'máng  
 be in a hurry

### 朝 zhāo

- ① early morning; morning ② day  
 朝晖 zhāo'huī  
 morning sunlight  
 朝气 zhāo'qì  
 vigour; vitality  
 朝阳 zhāo'yáng  
 the morning sun

### 者 zhě

- er; -or; -ist; -est  
 作者 zuò'zhě  
 writer  
 长者 zhǎng'zhě  
 eldest; elder

### 哲 zhé

- ① wise; sagacious  
 ② wise man; sage  
 哲理 zhé'lǐ  
 philosophic theory  
 哲学 zhé'xué  
 philosophy

### 折 zhé

- ① break; snap ② suffer the loss  
 of; lose ③ bend; twist ④ turn back;  
 change direction ⑤ be convinced;  
 be filled with admiration  
 折尺 zhé'chǐ  
 folding ruler  
 折叠床 zhé'dié'chuáng  
 folding bed  
 折扣 zhé'kòu  
 discount; rebate

### 兆 zhào

- ① sign; omen; portent  
 ② foretell  
 ③ mega  
 兆赫 zhào'hè  
 megahertz  
 兆头 zhào'tou  
 sign; omen; portent

### 罩 zhào

- ① cover; overspread; wrap  
 ② shade; hood; casing  
 罩衫 zhào'shān  
 overall; dustcoat  
 罩衣 zhào'yī  
 dustcoat  
 罩子 zhào'zi  
 cover; shade; hood

### 针 zhēn

- ① needle ② stitch ③ injection;  
 shot ④ acupuncture  
 针灸 zhēn'jiǔ  
 acupuncture  
 针织 zhēn'zhī  
 knitting  
 针织品 zhēn'zhī'pǐn  
 knitwear

### 贞 zhēn

- ① loyal; faithful  
 ② chastity or virginity  
 贞操 zhēn'cāo  
 chastity or virginity  
 贞洁 zhēn'jié  
 chaste and undefiled

### 珍 zhēn

- ① treasure ② precious; valuable  
 ③ value highly  
 珍宝 zhēn'bǎo  
 jewellery; treasure  
 珍本 zhēn'běn  
 rare edition; rare book  
 珍珠 zhēn'zhū  
 pearl

### 真 zhēn

- ① true; genuine ② really; truly;  
 indeed ③ clearly; unmistakably  
 真金 zhēn'jīn  
 true gold  
 真理 zhēn'lǐ  
 truth  
 真丝 zhēn'sī  
 real silk

### 这 zhè

- ① this ② now  
 这边 zhè'biān  
 this side; here  
 这里 zhè'lǐ  
 here  
 这些 zhè'xiē  
 these

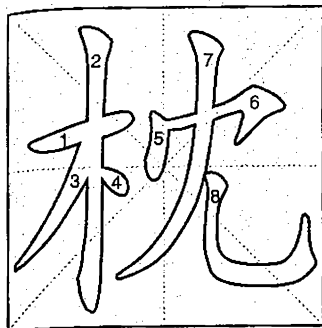

枕 zhěn 1951

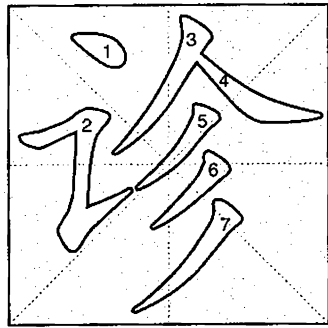

珍 zhēn 1952

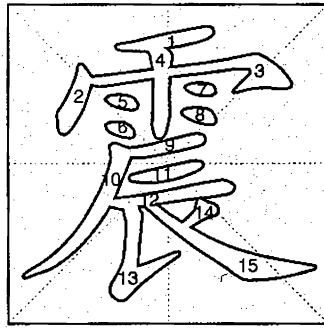

震 zhèn 1953

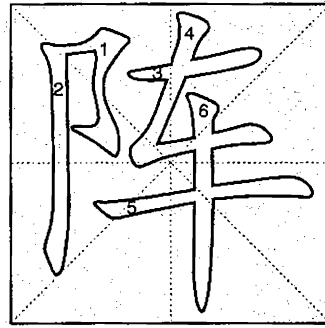

阵 zhèn 1954

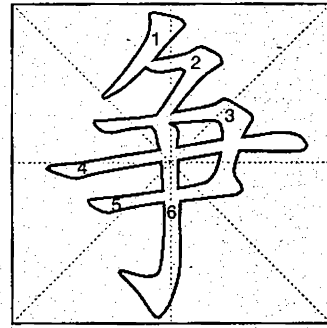

争 zhēng 1955

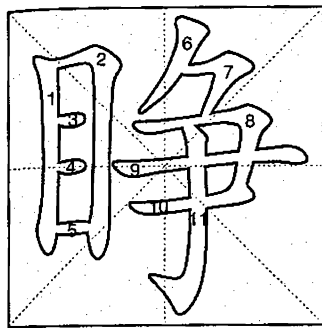

睁 zhēng 1956

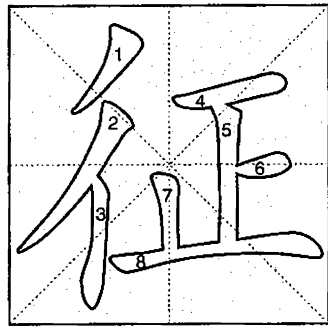

征 zhēng 1957

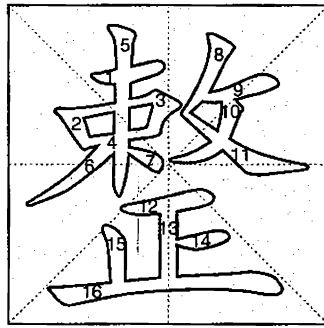

整 zhěng 1958

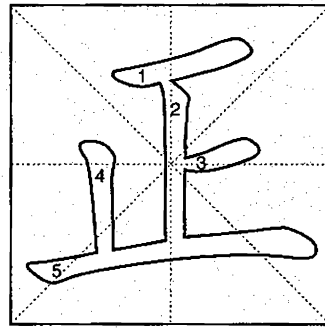

正 zhèng 1959

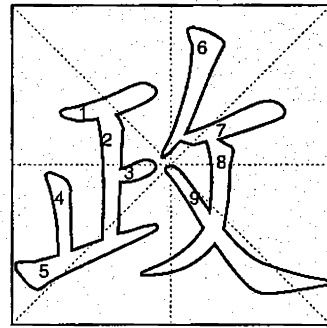

政 zhèng 1960

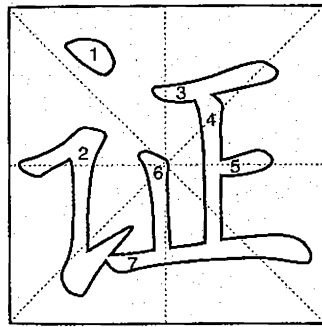

证 zhèng 1961

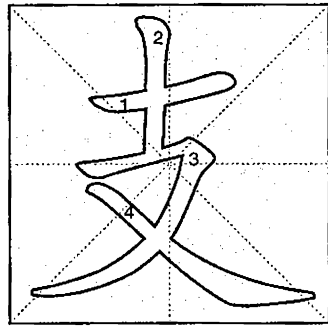

支 zhī 1962

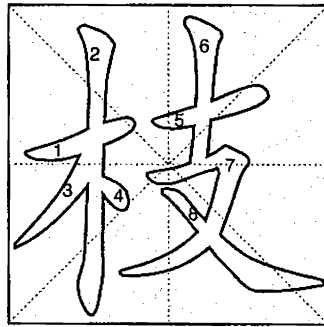

枝 zhī 1963

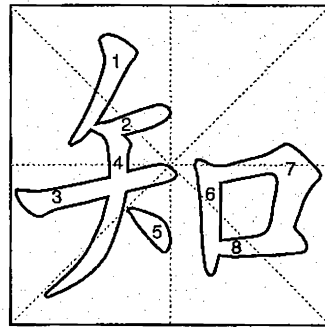

知 zhī 1964

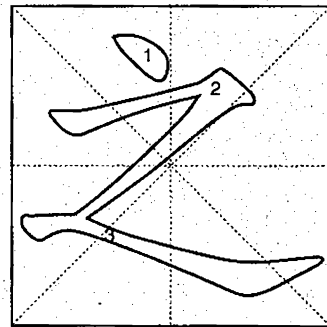

之 zhī 1965

### 争 zhēng

- ①contend; vie; strive  
 ②argue; dispute  
 争吵 zhēng'chǎo  
 quarrel; bicker  
 争取 zhēng'qǔ  
 strive for; fight for  
 争议 zhēng'yì  
 dispute; controversy

### 阵 zhèn

- ①battle array ②position; front  
 ③a period of time ④blast; spasm  
 阵风 zhèn'fēng  
 gust; puff of wind  
 阵亡 zhèn'wáng  
 be killed in action  
 阵营 zhèn'yíng  
 camp

### 震 zhèn

- ①shake; vibrate ②greatly excited; deeply astonished  
 震波 zhèn'bō  
 earthquake wave  
 震区 zhèn'qū  
 earthquake region  
 震中 zhèn'zhōng  
 epicenter; epicentral

### 诊 zhěn

- examine (a patient)  
 诊断 zhěn'diàn  
 diagnose  
 诊所 zhěn'suǒ  
 clinic  
 诊治 zhěn'zhì  
 diagnosis and treatment

### 枕 zhěn

- ①pillow ②rest the head on  
 枕巾 zhěn'jīn  
 pillow case cover  
 枕木 zhěn'mù  
 sleeper; tie  
 枕头 zhěn'tou  
 pillow

### 政 zhèng

- politics; political affairs  
 政变 zhèng'biàn  
 coup; coup d'état  
 政府 zhèng'fǔ  
 government  
 政客 zhèng'kè  
 politician

### 正 zhèng

- ①straight; upright ②situated in the middle; main ③(time) punctually; sharp ④obverse; right ⑤honest; upright  
 正版 zhèng'bǎn  
 legal copy; official edition  
 正点 zhèng'diǎn  
 on schedule; on time  
 正文 zhèng'wén  
 text

### 整 zhěng

- ①whole; complete; full; entire  
 ②in good order; neat; tidy ③put in order; rectify ④repair; mend  
 整洁 zhěng'jié  
 clean and tidy; neat  
 整日 zhěng'rì  
 whole day; all day long  
 整容 zhěng'róng  
 tidy up one's appearance

### 征 zhēng

- ①go on a journey ②go on an expedition ③levy (troops); call up  
 ④levy (taxes); impose  
 征程 zhēng'chéng  
 journey  
 征求 zhēng'qiú  
 solicit; seek; ask for  
 征兆 zhēng'zhào  
 sign; omen; portent

### 睁 zhēng

- open (the eyes)

### 之 zhī

- ①someone; something ②of  
 之间 zhī'jiān  
 between; among  
 之前 zhī'qián  
 before; prior to; ago  
 之中 zhī'zhōng  
 in; in the midst of; among

### 知 zhī

- ①know; realize ②knowledge  
 知道 zhī'dào  
 know; realize  
 知识 zhī'shi  
 knowledge  
 知音 zhī'yīn  
 bosom friend

### 枝 zhī

- branch; twig  
 枝节 zhī'jié  
 branches and knots  
 枝条 zhī'tiáo  
 branch; twig  
 枝子 zhī'zi  
 branch; twig

### 支 zhī

- ①prop up; put up ②protrude; raise ③support; sustain; bear  
 ④send away ⑤pay or draw(money)  
 支付 zhī'fù  
 pay  
 支行 zhī'háng  
 subbranch  
 支取 zhī'qǔ  
 draw

### 证 zhèng

- ①prove; demonstrate ②proof; testimony ③certificate; card  
 证据 zhèng'jù  
 evidence; proof; testimony  
 证人(法) zhèng'rén(fǎ)  
 witness  
 证书 zhèng'shū  
 certificate; credentials

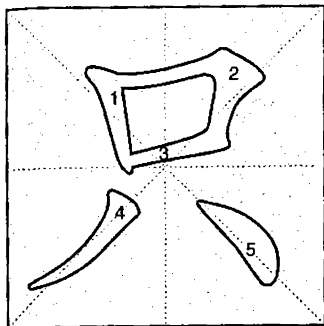

只 zhī 1966

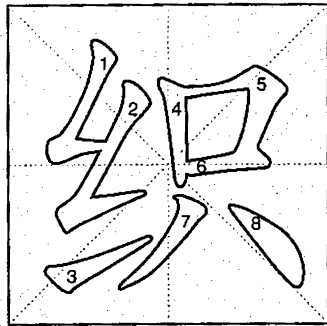

织 zhī 1967

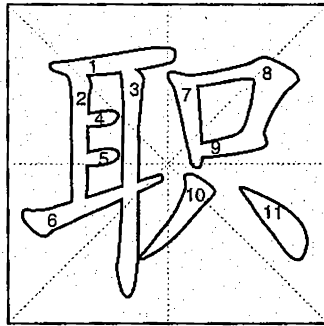

职 zhí 1968

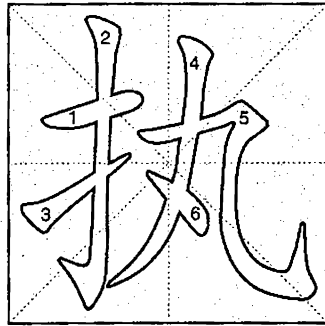

执 zhí 1969

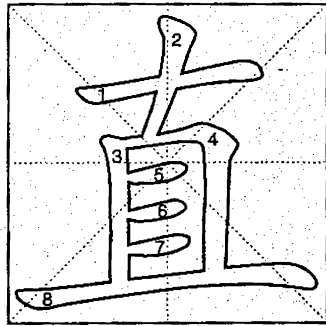

直 zhí 1970

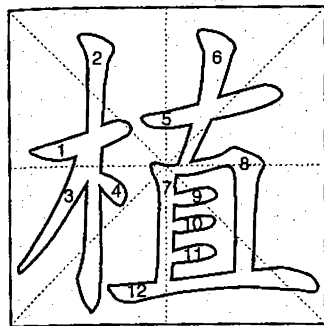

植 zhí 1971

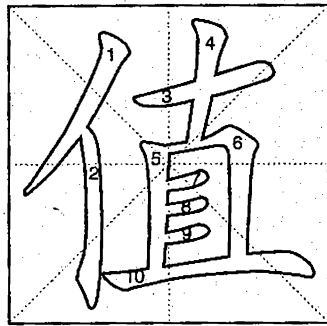

值 zhí 1972

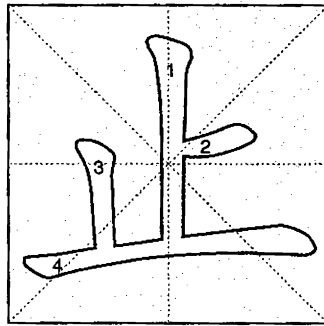

止 zhǐ 1973

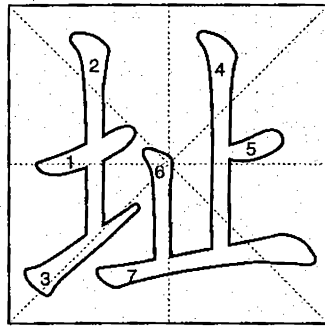

址 zhǐ 1974

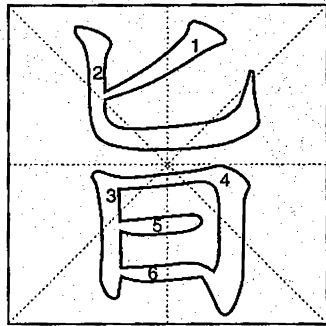

旨 zhǐ 1975

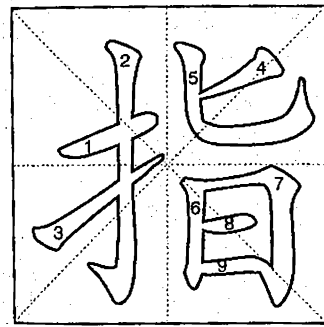

指 zhǐ 1976

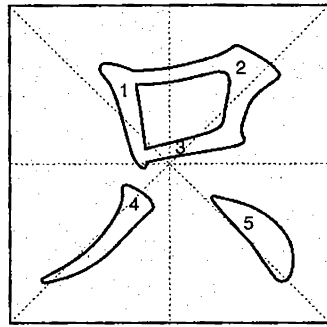

只 zhǐ 1977

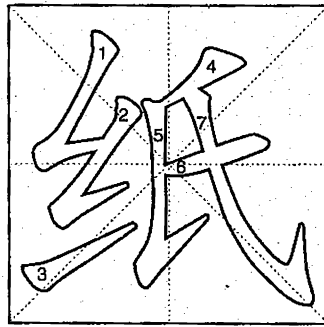

纸 zhǐ 1978

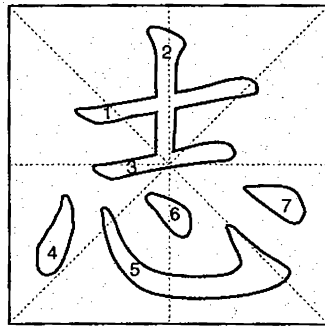

志 zhì 1979

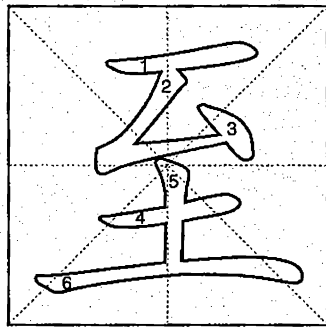

至 zhì 1980

### 直 zhí

①straight ②straighten ③vertical; perpendicular ④just; upright ⑤frank; straightforward ⑥directly

直拨 zhí'bō

direct dialing

直达 zhí'dá

through; nonstop

直飞 zhí'fēi

direct flight

### 执 zhí

①hold; grasp ②take charge of; direct; manage ③stick to (one's views, etc.); persist

执笔 zhí'bǐ

write

执教 zhí'jiào

teach; coach

执照 zhí'zhào

license; permit

### 职 zhí

①duty; job ②post; office

职工 zhí'gōng

staff and workers

职位 zhí'wèi

position

职务 zhí'wù

post; duties; job

### 织 zhī

①weave ②knit

织布 zhī'bù

weaving cotton cloth

织机 zhī'jī

loom

织物 zhī'wù

fabric

### 只 zhī

single; one only

只身 zhī'shēn

alone; by oneself

只言片语 zhī'yán'piàn'yǔ

a word or two

### 旨 zhǐ

①purpose; purpose; aim

②decree

旨意 zhǐ'yì

decree; order

### 址 zhǐ

location; site

地址 dì'zhǐ

address

### 止 zhǐ

①stop ②to; till ③only

止步 zhǐ'bù

halt; stop; go no further

止咳 zhǐ'kē

relieve a cough

止血 zhǐ'xuè

stop bleeding

### 值 zhí

①value ②be worth

③take one's turn at sth.

值班 zhí'bān

be on duty

值钱 zhí'qián

costly; valuable

值日 zhí'rì

be on duty for the day

### 植 zhí

plant; grow

植树 zhí'shù

tree planting

植人物 zhí'wù'rén

human vegetable

植物园 zhí'wù'yuán

botanical garden

### 至 zhì

①to; until ②most

至交 zhì'jiāo

best friend

至今 zhì'jīn

up to now; so far; to date

至亲 zhì'qīn

close relative

### 志 zhì

①will; ideal ②keep in mind

大志 dà'zhì

lofty ambition; high aim

### 纸 zhǐ

paper

纸币 zhǐ'bì

paper money; note

纸巾 zhǐ'jīn

facial-tissue; tissue-paper

纸烟 zhǐ'yān

cigarette

### 只 zhǐ

only; merely

只不过 zhǐ'bú'guò

only; just; merely

只好 zhǐ'hǎo

have to; be forced to

只要 zhǐ'yào

so long as; provided

### 指 zhǐ

①finger ②point at; point to

③indicate; refer to

④depend on; count on

指出 zhǐ'chū

point out

指甲刀 zhǐ'jiǎ'dāo

nail clippers

指甲油 zhǐ'jiǎ'yóu

nail polish

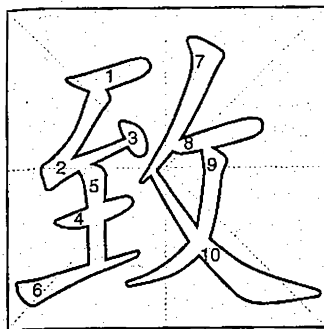

致 zhì 1981

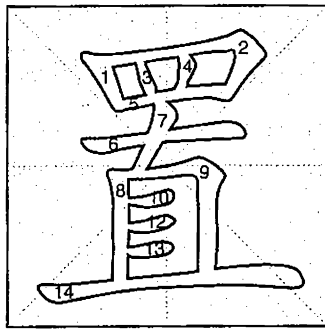

置 zhì 1982

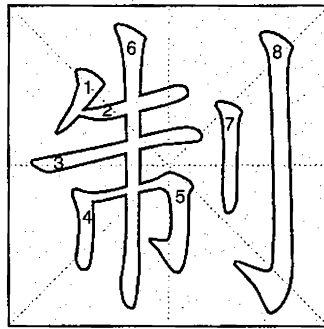

制 zhì 1983

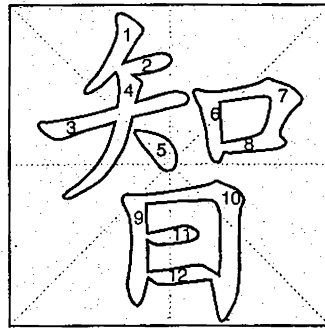

智 zhì 1984

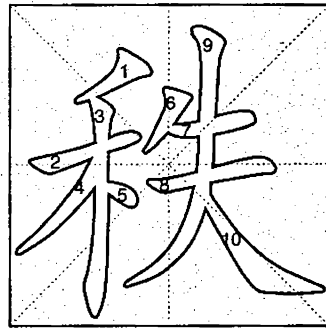

秩 zhì 1985

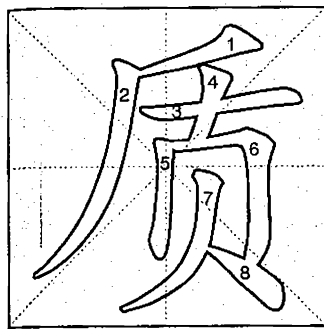

质 zhì 1986

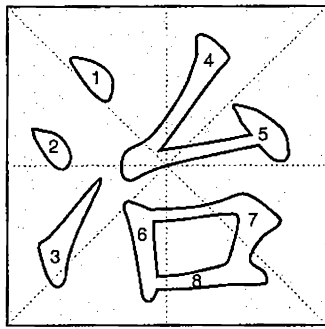

治 zhì 1987

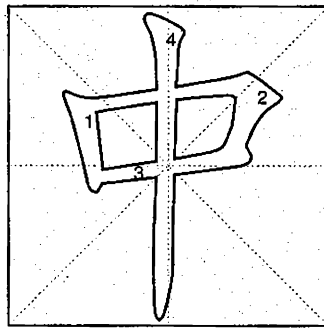

中 zhōng 1988

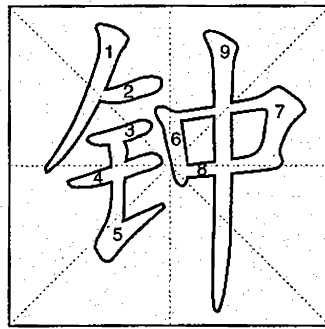

钟 zhōng 1989

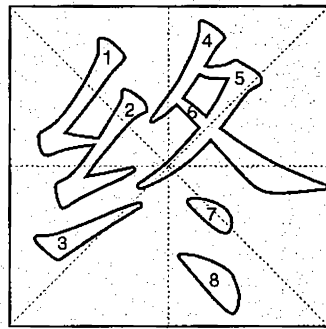

终 zhōng 1990

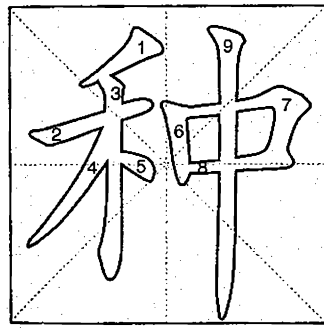

种 zhǒng 1991

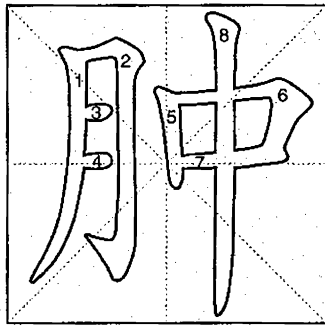

肿 zhǒng 1992

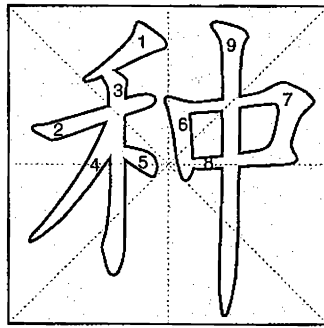

种 zhòng 1993

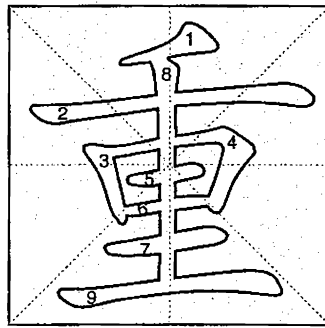

重 zhòng 1994

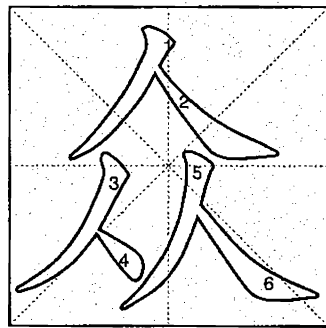

众 zhòng 1995

### 秩 zhì

order  
秩序 zhì'xù  
order; sequence

### 智 zhì

wisdom; resourcefulness; wit  
智慧 zhì'hui  
wisdom; intelligence  
智能卡 zhì'néng'kǎ  
intelligence card  
智商 zhì'shāng  
intelligence quotient (IQ)

### 制 zhì

①make; manufacture ②work out  
③restrict; control ④system  
制版〈印〉 zhì'bǎn 〈yìn〉  
plate making  
制订 zhì'dìng  
work out  
制片人 zhì'piān'rén  
producer

### 置 zhì

①place; put ②set up; establish;  
install ③buy; purchase  
置办 zhì'bàn  
purchase; buy  
置疑 zhì'yí  
doubt  
置之不理 zhì'zhī'bù'lǐ  
ignore

### 致 zhì

①send; deliver ②devote (one's  
efforts, etc.) ③incur; result in;  
cause ④fine; delicate  
致癌 zhì'ái  
carcinogenic  
致函 zhì'hán  
send a letter to  
致谢 zhì'xiè  
extend thanks to

### 终 zhōng

①end; finish ②death; end  
③eventually; in the end  
④whole; entire; all  
终点 zhōng'diǎn  
terminal point; end point  
终生 zhōng'shēng  
all one's life  
终于 zhōng'yú  
at last; in the end; finally

### 钟 zhōng

①bell ②clock ③time as mea-  
sured in hours and minutes ④con-  
centrate (one's affections, etc.)  
钟表 zhōng'biǎo  
clocks and watches  
钟点 zhōng'diǎn  
time; hour  
钟头 zhōng'tóu  
hour

### 中 zhōng

①centre; middle ②China ③in;  
among; amidst ④middle ⑤medium;  
intermediate ⑥mean  
中东 zhōng'dōng  
the Middle East  
中国 zhōng'guó  
China  
中立国 zhōng'lì'guó  
neutral state

### 治 zhì

①rule; govern; administer; manage  
②order; peace  
③treat(a disease); cure  
④control; harness(a river)  
治国 zhì'guó  
run a country  
治理 zhì'lǐ  
govern; administer  
治疗 zhì'liáo  
treat; cure

### 质 zhì

①nature; character ②quality  
③simple; plain ④question  
质地 zhì'dì  
texture  
质量 zhì'liàng  
quality  
质问 zhì'wèn  
question

### 众 zhòng

①many; numerous  
②crowd; multitude  
众多 zhòng'duō  
multitudinous  
众人 zhòng'rén  
everybody  
众议院 zhòng'yì'yuàn  
House of Representatives; Cham-  
ber of Deputies

### 重 zhòng

①weight ②heavy; weighty  
③considerable in amount or value  
④deep; serious ⑤attach importance  
to  
重担 zhòng'dàn  
difficult task  
重犯 zhòng'fàn  
major criminal  
重量 zhòng'liàng  
weight

### 种 zhòng

grow; plant; cultivate  
种花 zhòng'huā  
grow flowers  
种田 zhòng'tián  
till land; farm  
种植 zhòng'zhí  
plant; grow

### 肿 zhǒng

swelling  
肿块 zhǒng'kuài  
phyma; tumor; mass  
肿瘤 zhǒng'liú  
tumor  
肿胀 zhǒng'zhàng  
swelling

### 种 zhǒng

① species ② race ③ seed;  
strain; breed ④kind; sort; type  
种马 zhǒng'mǎ  
stud  
种子 zhǒng'zi  
seed  
种族 zhǒng'zú  
race

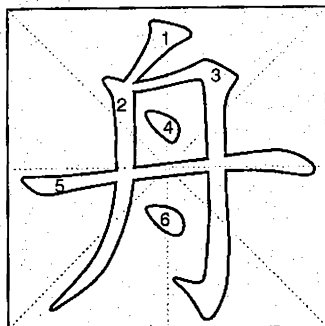

舟 zhōu 1996

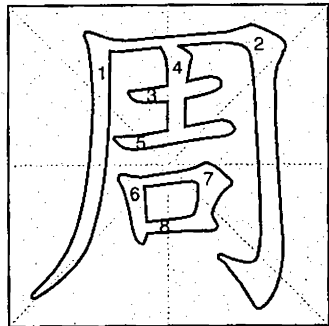

周 zhōu 1997

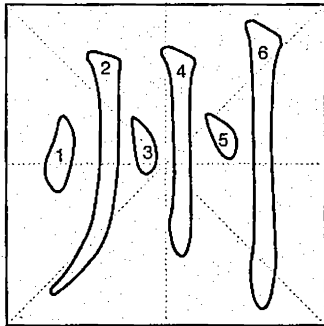

州 zhōu 1998

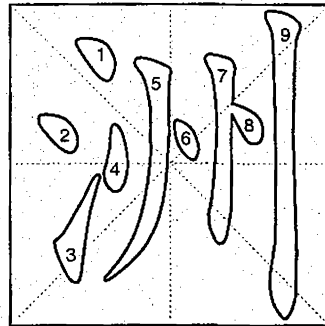

洲 zhōu 1999

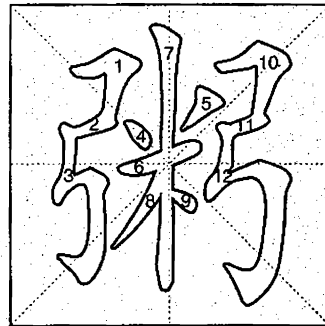

粥 zhōu 2000

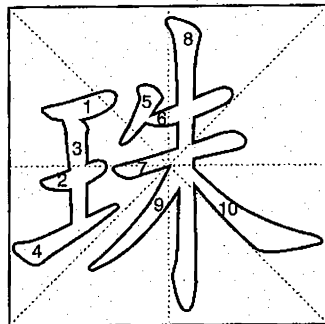

珠 zhū 2001

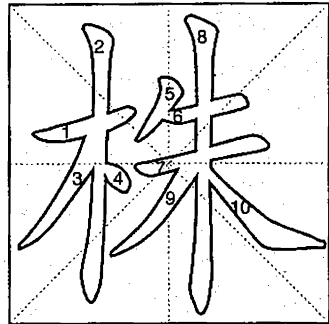

株 zhū 2002



猪 zhū 2003

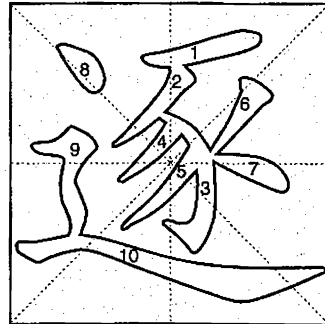

逐 zhú 2004

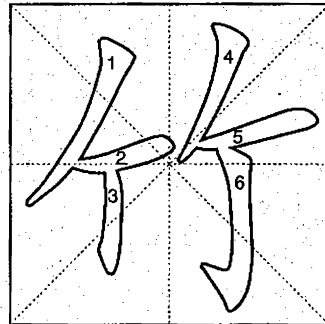

竹 zhú 2005

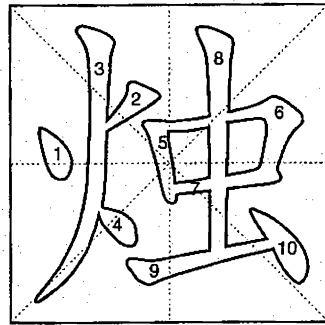

烛 zhú 2006

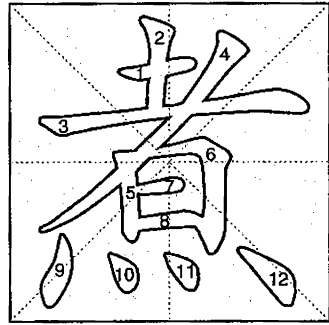

煮 zhǔ 2007

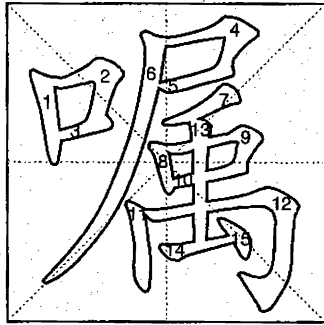

嘱 zhǔ 2008

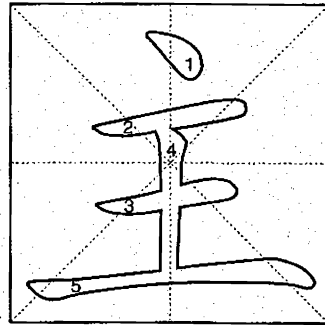

主 zhǔ 2009

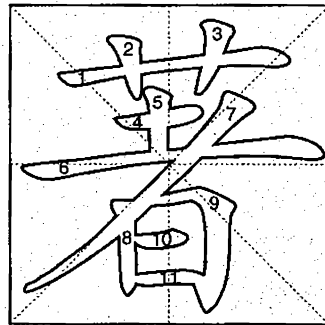

著 zhù 2010



### 粥 zhōu

gruel (made of rice, millet, etc.);  
porridge; congee  
粥少僧多 zhōu'shǎo'sēng'duō  
little gruel and many monks

### 洲 zhōu

①continent  
②islet in a river; sand bar  
洲际 zhōu'jì  
intercontinental

### 州 zhōu

①an administrative division  
②(autonomous) prefecture

### 周 zhōu

①circumference; periphery; circuit  
②all; whole ③thoughtful; attentive  
周报 zhōu'bào  
weekly  
周末 zhōu'mò  
weekend  
周游 zhōu'yóu  
travel round

### 舟 zhōu

boat  
舟车 zhōu'chē  
vessel and vehicle

### 竹 zhú

bamboo  
竹竿 zhú'gān  
bamboo (pole)  
竹林 zhú'lín  
bamboo groves  
竹笋 zhú'sǔn  
bamboo shoots

### 逐 zhú

①pursue; chase ②drive out; expel  
③one by one  
逐步 zhú'bù  
step by step  
逐年 zhú'nián  
year by year  
逐一 zhú'yī  
one by one

### 猪 zhū

pig; hog; swine  
猪场 zhū'chǎng  
pig farm  
猪排 zhū'pái  
pork chop  
猪肉 zhū'ròu  
pork

### 株 zhū

①trunk of a tree; stem of a plant  
②(individual) plant  
株连 zhū'lián  
implicate

### 珠 zhū

①pearl ②bead  
珠宝 zhū'bǎo  
pearls and jewels:~商 jeweller ~  
店 jeweller's (shop)  
珠光宝气 zhū'guāng'bǎo'qì  
be richly jewelled  
珠穆朗玛峰 zhū'mù'lǎng'mǎ'fēng  
Mount Qomolangma

### 著 zhù

①marked; outstanding ②write  
③book; work  
著者 zhù'zhě  
author  
著作 zhù'zuò  
works; writings  
著作权 zhù'zuò'quán  
copyright

### 主 zhǔ

①host ②owner; master ③main;  
primary ④manage ⑤hold a definite  
view about sth.  
主办 zhǔ'bàn  
sponsor  
主教 zhǔ'jiào  
bishop  
主教练 zhǔ'jiào'liàn  
the principal coach

### 嘱 zhǔ

enjoin; advise; urge  
嘱咐 zhǔ'fù  
tell; exhort  
嘱托 zhǔ'tuō  
entrust

### 煮 zhǔ

boil; cook  
煮沸 zhǔ'fěi  
boil  
煮熟 zhǔ'shú  
cook thoroughly

### 烛 zhú

①candle ②illuminate ③watt  
烛光 zhú'guāng  
candle light  
烛花 zhú'huā  
snuff  
烛台 zhú'tái  
candlestick

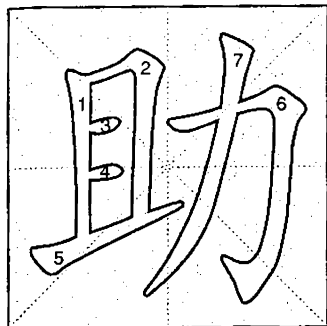

助 zhù 2011



筑 zhù 2012

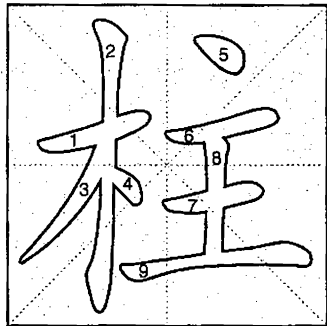

柱 zhù 2013

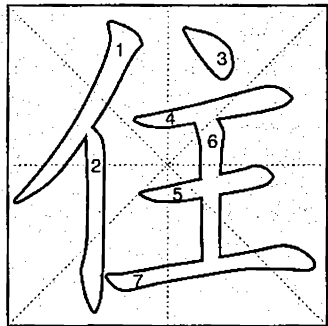

住 zhù 2014

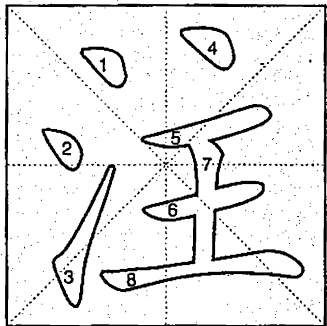

注 zhù 2015

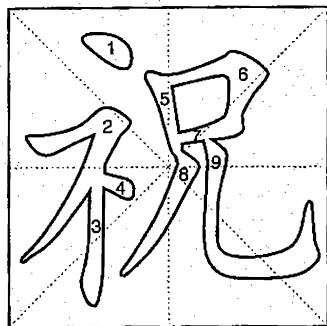

祝 zhù 2016

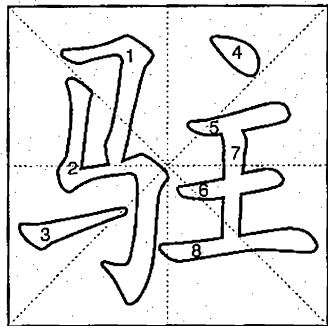

驻 zhù 2017

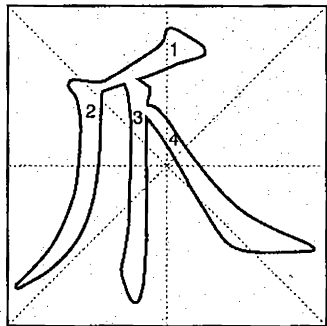

爪 zhuǎ 2018

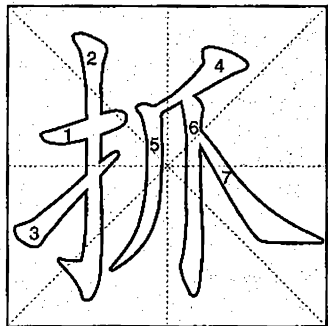

抓 zhuā 2019

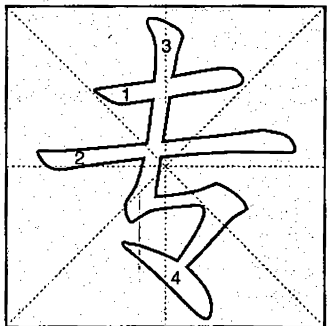

专 zhuān 2020

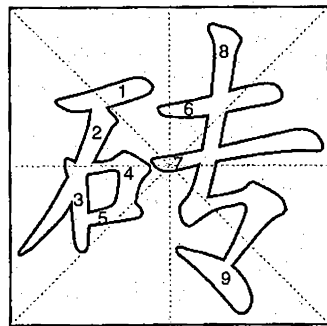

砖 zhuān 2021

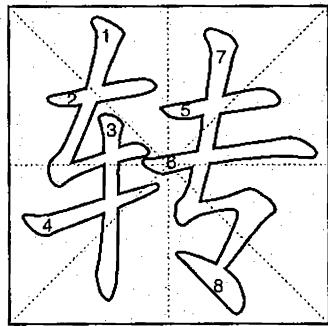

转 zhuǎn 2022

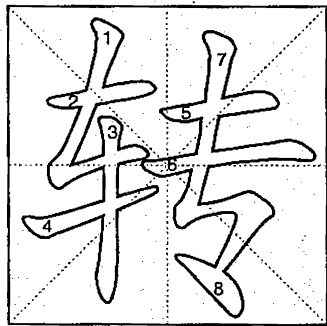

转 zhuàn 2023

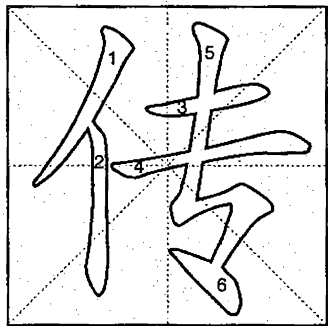

传 zhuàn 2024

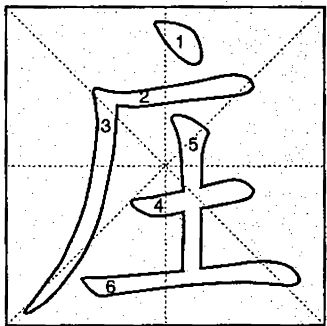

庄 zhuāng 2025

**注 zhù**

- ①pour ②concentrate; fix  
 ③stakes (in gambling)  
 ④annotate; notes  
 注册 zhù'cè  
 register: ~ 商标 registered trade-mark  
 注销 zhù'xiāo  
 cancel; write off  
 注意 zhù'yì  
 pay attention to; heed

**住 zhù**

- ①live; reside; stay ②stop; cease  
 住地 zhù'dì  
 residence  
 住口 zhù'kǒu  
 shut up  
 住址 zhù'zhǐ  
 address

**柱 zhù**

- post; upright; pillar; column  
 柱石 zhù'shí  
 pillar; mainstay  
 柱子 zhù'zi  
 post; pillar

**筑 zhù**

- build; construct  
 建筑 jiàn'zhù  
 build; erect; building

**助 zhù**

- help; assist; aid  
 助教 zhù'jiào  
 assistant  
 助手 zhù'shǒu  
 assistant; helper; aide  
 助听器 zhù'tīng'qì  
 audiphone; deaf-aid

**专 zhuān**

- ①focussed on one thing ②special ③expert ④monopolize (power)  
 专长 zhuān'cháng  
 speciality  
 专号 zhuān'hào  
 special issue  
 专利 zhuān'lì  
 patent  
 专著 zhuān'zhù  
 monograph; treatise

**抓 zhuā**

- ①grab; seize; clutch ②scratch  
 ③arrest; catch; press-gang  
 ④pay special attention to  
 抓获 zhuā'huò  
 arrest; catch  
 抓举〈举重〉 zhuā'jǔ〈jǔ'zhòng〉  
 snatch  
 抓住 zhuā'zhù  
 seize hold of; catch

**爪 zhuǎ**

- claw; talon  
 爪子 zhuǎ'zi  
 claw; paw; talon

**驻 zhù**

- ①halt; stay ②be stationed  
 驻防 zhù'fāng  
 be on garrison duty  
 驻军 zhù'jūn  
 garrison

**祝 zhù**

- wish  
 祝贺 zhù'hè  
 congratulate  
 祝酒 zhù'jiǔ  
 drink a toast; toast  
 祝愿 zhù'yuàn  
 wish

**庄 zhuāng**

- ①village ②a place of business  
 庄稼 zhuāng'jiā  
 crops  
 庄严 zhuāng'yán  
 solemn; stately  
 庄园 zhuāng'yuán  
 manor

**传 zhuàn**

- ①commentaries on classics  
 ②biography ③a novel or story written in historical style  
 传记 zhuàn'jì  
 biography  
 传略 zhuàn'lüè  
 biographical sketch

**转 zhuǎn**

- ①turn; revolve; rotate  
 ②revolution  
 转笔刀 zhuǎn'bǐ'dāo  
 pencil sharpener  
 转门 zhuǎn'mén  
 revolving door  
 转椅 zhuǎn'yǐ  
 revolving chair

**转 zhuǎn**

- ①turn; shift; change  
 ②pass on; transfer  
 转播台 zhuǎn'bō'tái  
 relay station  
 转车 zhuǎn'chē  
 transfer to another train or bus  
 转告 zhuǎn'gào  
 pass on ... (to sb.)

**砖 zhuān**

- brick  
 砖茶 zhuān'chá  
 brick tea  
 砖厂 zhuān'chǎng  
 brick yard  
 砖头 zhuān'tóu  
 brick

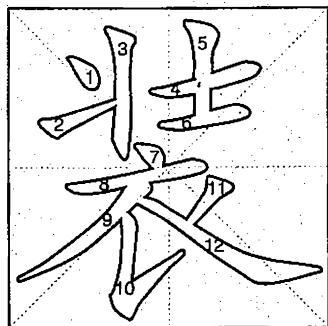

装 zhuāng 2026

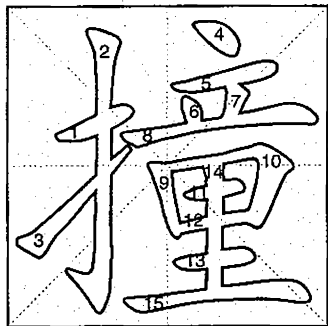

撞 zhuàng 2027

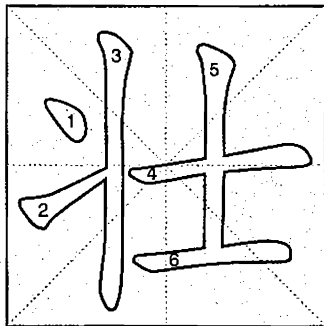

壮 zhuàng 2028

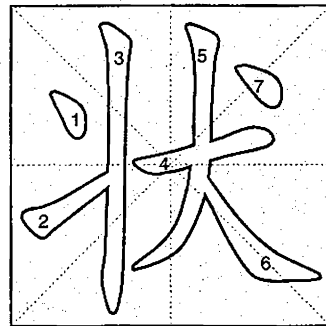

状 zhuàng 2029

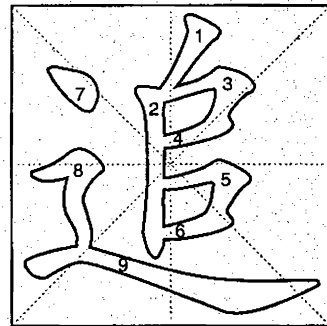

追 zhuī 2030

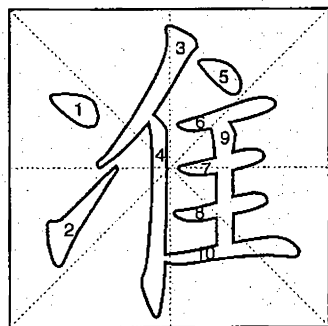

准 zhǔn 2031

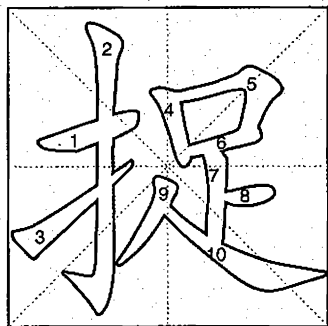

捉 zhuō 2032

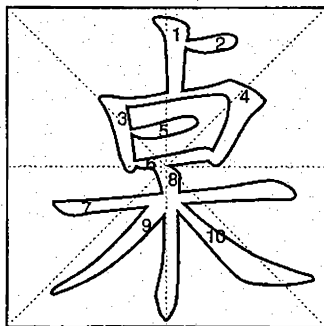

桌 zhuō 2033

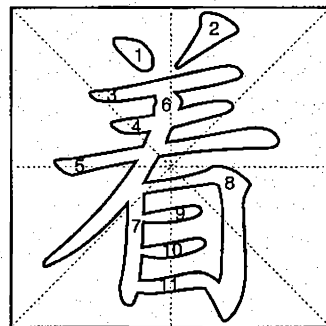

着 zhuó 2034

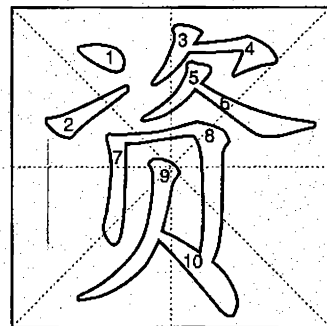

资 zī 2035

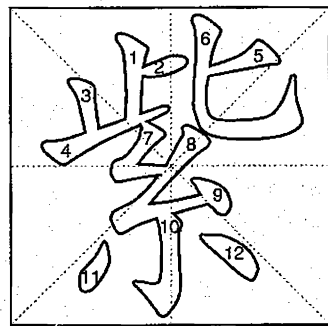

紫 zǐ 2036

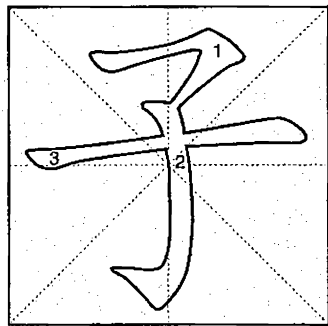

子 zǐ 2037

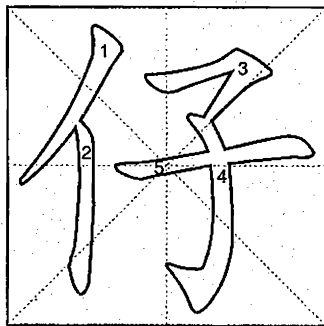

仔 zǐ 2038

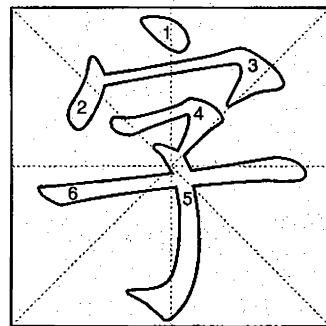

字 zì 2039

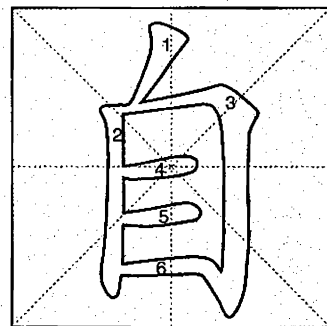

自 zì 2040

### 追 zhuī

- ① chase after; pursue ② trace  
③ seek; go after ④ recall  
追捕 zhuī'bǔ  
pursue a criminal  
追赶 zhuī'gǎn  
run after; pursue  
追加 zhuī'jiā  
add to

### 状 zhuàng

- ① form; shape ② state; condition  
③ describe ④ written complaint  
⑤ certificate (of commendation, etc.)  
状况 zhuàng'kuàng  
condition; state  
状语〈语〉 zhuàng'yǔ(yǔ)  
adverbial  
状子 zhuàng'zi  
plaint

### 壮 zhuàng

- ① strong; robust; ~ 苗 strong  
sprout ② magnificent; grand  
③ strengthen; make better  
壮观 zhuàng'guān  
magnificent sight  
壮烈 zhuàng'liè  
heroic; brave  
壮年 zhuàng'nián  
prime of life

### 撞 zhuàng

- ① bump against; strike; collide  
② meet by chance; run into  
③ rush; dash; barge  
撞车 zhuàng'chē  
collision; clash  
撞击 zhuàng'jī  
ram; dash against  
撞伤 zhuàng'shāng  
crush injury

### 装 zhuāng

- ① dress up; play the part of; act;  
deck ② outfit; clothing ③ stage-  
makeup and costume ④ pretend;  
feign; make believe  
装扮 zhuāng'bàn  
dress up; disguise  
装订 zhuāng'dìng  
binding; bookbinding  
装货 zhuāng'huò  
load; loading

### 资 zī

- ① money ② subsidize; support  
③ provide; supply ④ natural ability  
⑤ qualifications  
资格 zī'gé  
qualifications  
资金 zī'jīn  
fund  
资料 zī'lìào  
data; information

### 着 zhuó

- ① wear (clothes) ② touch  
③ apply; use ④ whereabouts  
着陆 zhuó'lù  
land; touch down  
着手 zhuó'shǒu  
set about; begin  
着重 zhuó'zhòng  
stress; emphasize

### 桌 zhuō

- table; desk  
桌布 zhuō'bù  
tablecloth  
桌灯 zhuō'dēng  
desk lamp  
桌子 zhuō'zi  
table; desk

### 捉 zhuō

- ① clutch; hold; grasp  
② catch; capture  
捉迷藏 zhuō'mí'cáng  
hide-and-seek  
捉拿 zhuō'ná  
arrest; catch  
捉弄 zhuō'nòng  
make fun of; tease

### 准 zhǔn

- ① allow; grant; permit ② stan-  
dard; norm ③ accurate; exact  
④ definitely; certainly  
准备 zhǔn'bèi  
prepare; get ready  
准时 zhǔn'shí  
punctual; on time  
准许 zhǔn'xǔ  
permit; allow

### 自 zì

- ① self; oneself; one's own  
② certainly; of course  
③ from; since  
自从 zì'cóng  
since  
自动 zì'dòng  
voluntarily; automatic  
自己 zì'jǐ  
oneself

### 字 zì

- ① word; character ② pronuncia-  
tion (of a word or character) ③ style  
of handwriting; printing type  
字典 zì'diǎn  
dictionary  
字画 zì'huà  
calligraphy and painting  
字母 zì'mǔ  
letter: 大写~a capital letter

### 仔 zǐ

- young  
仔鸡 zǐ'jī  
chick  
仔细 zǐ'xì  
careful; attentive  
仔鱼 zǐ'yú  
fry

### 子 zǐ

- ① son; child ② person ③ seed  
④ egg ⑤ young; tender; small  
⑥ something small and hard  
子弹 zǐ'dàn  
bullet  
子女 zǐ'nǚ  
children  
子夜 zǐ'yè  
midnight

### 紫 zǐ

- purple; violet  
紫菜 zǐ'cài  
laver  
紫丁香 zǐ'dīng'xiāng  
(early) lilac  
紫禁城 zǐ'jìn'chéng  
the Forbidden City

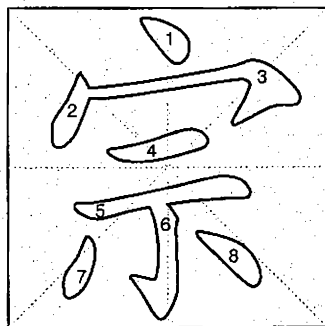

宗 zōng 2041

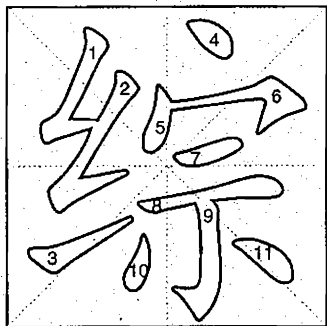

综 zōng 2042

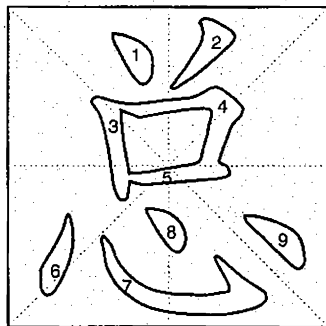

总 zǒng 2043

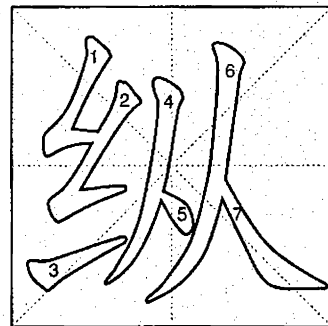

纵 zòng 2044

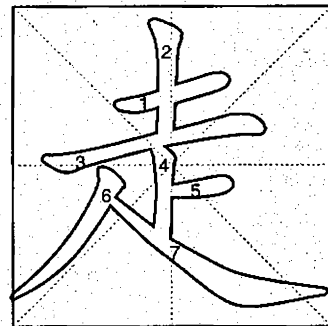

走 zǒu 2045

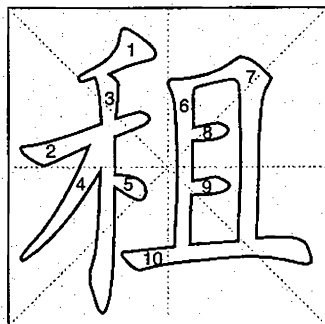

租 zū 2046

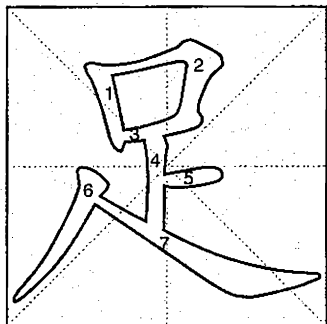

足 zú 2047

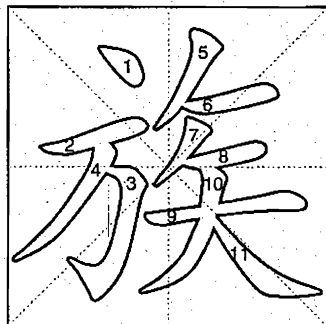

族 zú 2048

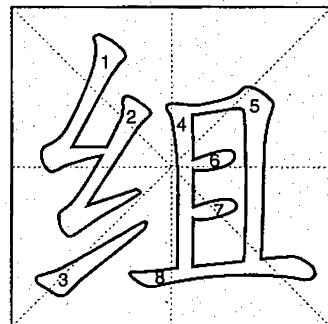

组 zǔ 2049

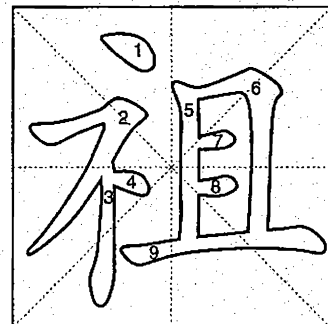

祖 zǔ 2050

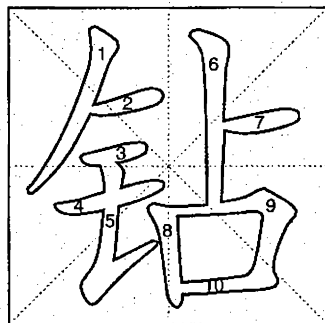

钻 zuàn 2051



嘴 zuǐ 2052

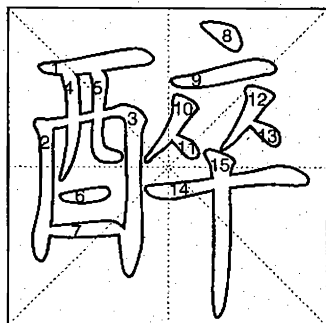

醉 zuì 2053

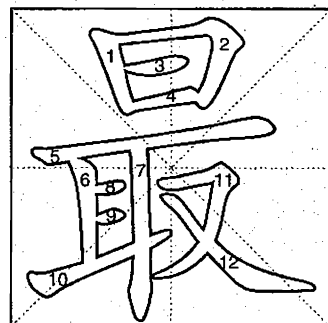

最 zuì 2054

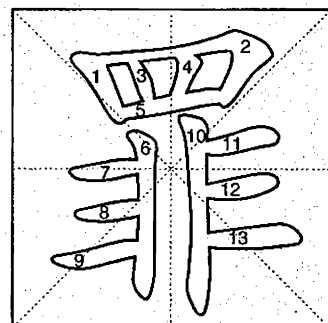

罪 zuì 2055

### 走 zǒu

①walk; go ②run; move  
 ③leave; go away ④visit; call on  
 ⑤through; from ⑥leak; escape  
 走钢丝 zǒu'gāng'sī  
 wirewalking  
 走俏 zǒu'qiào  
 sell well  
 走私 zǒu'sī  
 smuggle

### 纵 zòng

①vertical; longitudinal; lengthwise  
 ②release; set free ③let loose; let oneself go ④jump up  
 纵火犯 zòng'huǒ'fàn  
 arsonist  
 纵身 zòng'shēn  
 jump; leap  
 纵深 zòng'shēn  
 depth

### 总 zǒng

①assemble; put together ②general; overall ③chief; head ④allways; invariably ⑤anyway; after all  
 总部 zǒng'bù  
 the headquarters  
 总收入 zǒng'shōu'rù  
 general income  
 总司令 zǒng'sī'ling  
 commander-in-chief

### 综 zōng

put together; sum up  
 综合 zōng'hé  
 comprehensive  
 综述 zōng'shù  
 summarize; sum up  
 综艺 zōng'yì  
 comprehensive arts

### 宗 zōng

①ancestor ②clan ③sect; faction ④principal aim; purpose ⑤take as one's model ⑥model; great master  
 宗教 zōng'jiào  
 religion  
 宗派 zōng'pài  
 faction; sect  
 宗旨 zōng'zhǐ  
 aim; purpose

### 祖 zǔ

①grandfather ②ancestor ③founder (of a craft, religious sect, etc.); originator  
 祖父 zǔ'fù  
 grandfather  
 祖国 zǔ'guó  
 one's country; homeland  
 祖先 zǔ'xiān  
 ancestry; ancestors

### 组 zǔ

①organize; form ②group ③set; series  
 组成 zǔ'chéng  
 form; make up  
 组阁 zǔ'gé  
 form a cabinet  
 组织 zǔ'zhī  
 organize; tissue

### 族 zú

①clan ②race; nationality ③a class or group of things with common features  
 族群 zú'qún  
 social and cultural group of people  
 族人 zú'rén  
 clansman  
 族长 zú'zhǎng  
 the head of a clan

### 足 zú

①foot; leg ②full; as much as  
 足金 zú'jīn  
 pure gold; solid gold  
 足球 zú'qiú  
 football; soccer  
 足坛 zú'tán  
 football circles

### 租 zū

①rent; hire; charter ②rent out; let out; lease ③land tax  
 租界 zū'jiè  
 concession  
 租金 zū'jīn  
 rent; rental  
 租约 zū'yuē  
 lease

### 罪 zuì

①crime; guilt ②fault; blame ③suffering; hardship ④put the blame on  
 罪案 zuì'àn  
 case  
 罪恶 zuì'è  
 crime; evil  
 罪名 zuì'míng  
 charge; accusation

### 最 zuì

most  
 最初 zuì'chū  
 initial; first  
 最大 zuì'dà  
 maximum  
 最好 zuì'hǎo  
 best; first-rate

### 醉 zuì

①drunk; intoxicated; tipsy ②steeped in liquor  
 醉鬼 zuì'guǐ  
 drunkard; inebriate  
 醉心 zuì'xīn  
 be bent on  
 醉意 zuì'yì  
 signs of getting drunk

### 嘴 zuǐ

mouth  
 嘴巴 zuǐ'ba  
 face; mouth  
 嘴唇 zuǐ'chún  
 lip  
 嘴严 zuǐ'yán  
 able to keep a secret

### 钻 zuàn

①drill; auger ②drilling ③bore  
 钻井 zuàn'jǐng  
 well drilling  
 钻石 zuàn'shí  
 diamond; jewel  
 钻头 zuàn'tóu  
 bit (of a drill)

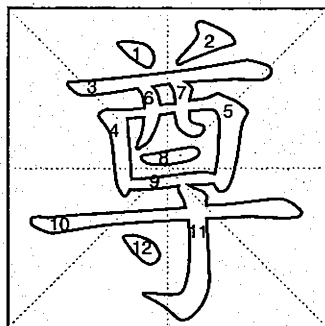

尊 zūn 2056

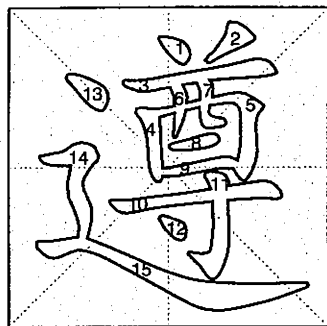

遵 zūn 2057

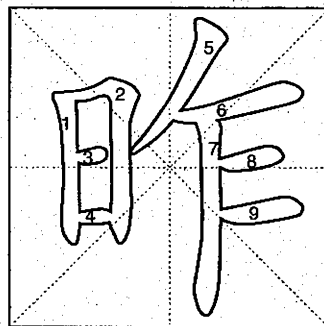

昨 zuó 2058

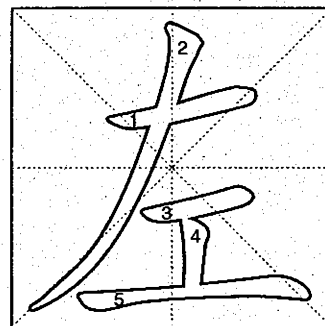

左 zuǒ 2059

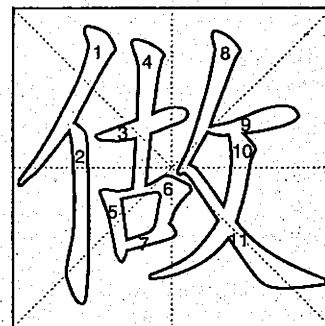

做 zuò 2060

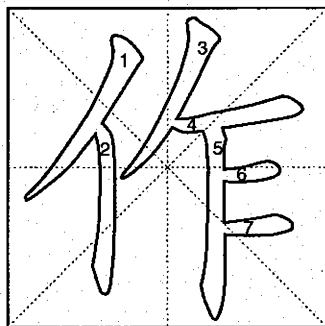

作 zuò 2061

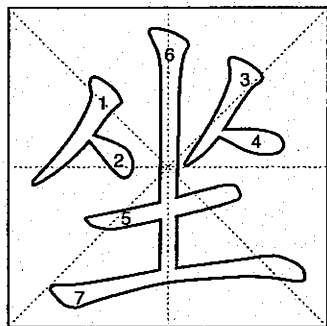

坐 zuò 2062

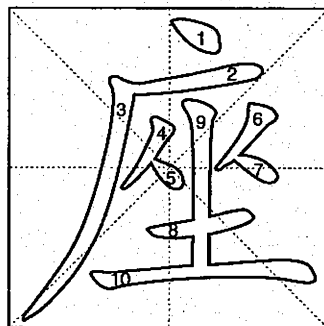

座 zuò 2063

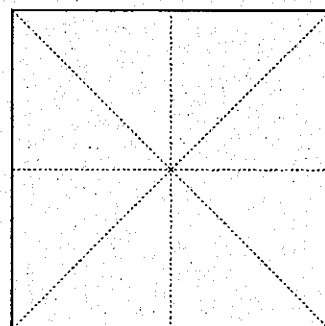
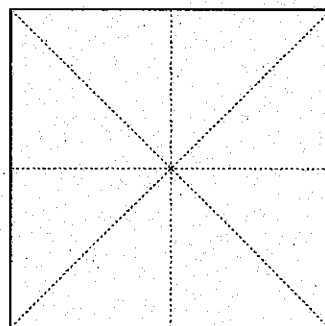
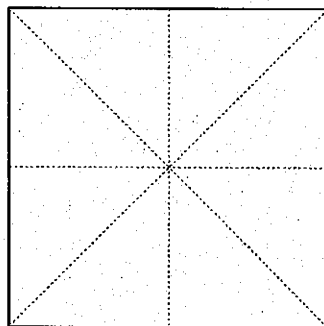
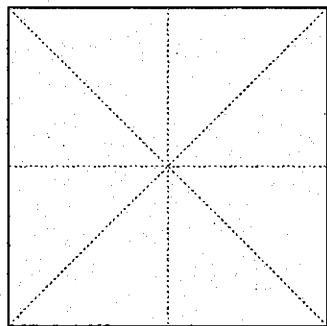
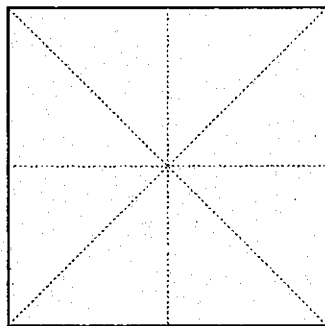
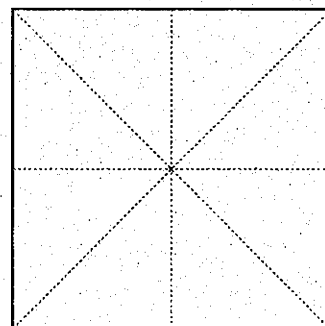
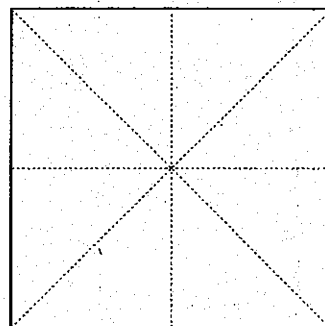



### 做 zuò

- ①make; produce; manufacture  
 ②cook; prepare ③do; act; engage  
 in ④be; become ⑤write; compose
- 做客 zuò'kè  
 be a guest
- 做礼拜 zuò'lǐ'bài  
 go to church
- 做生日 zuò'shēng'rì  
 celebrate sb's birthday

### 左 zuǒ

- ①the left side ②the left  
 ③different; contrary
- 左岸 zuǒ'àn  
 left bank
- 左手 zuǒ'shǒu  
 the left hand

### 昨 zuó

- yesterday
- 昨天 zuó'tiān  
 yesterday

### 遵 zūn

- abide by; obey; observe
- 遵命 zūn'mìng  
 obey your command
- 遵守 zūn'shǒu  
 observe; adhere to
- 遵照 zūn'zhào  
 act in accordance with

### 尊 zūn

- ①senior; of a senior generation  
 ②venerate; honour ③your
- 尊称 zūn'chēng  
 honorific title
- 尊贵 zūn'guì  
 honorable; respectable
- 尊重 zūn'zhòng  
 respect; esteem

### 座 zuò

- ①seat; place ②stand ③con-  
 stellation
- 座儿 zuò'er  
 seat; place
- 座谈会 zuò'tán'huì  
 forum
- 座钟 zuò'zhōng  
 desk clock

### 坐 zuò

- ①sit; take a seat ②travel by (a  
 plane, etc.) ③have its back towards
- 坐垫 zuò'diàn  
 cushion
- 坐牢 zuò'láo  
 be in jail; be imprisoned
- 坐落 zuò'luò  
 be situated; be located

### 作 zuò

- ①do; make ②write; compose  
 ③writings; work ④pretend; affect  
 ⑤regard as
- 作案 zuò'àn  
 commit a crime
- 作者 zuò'zhě  
 author; writer
- 作证 zuò'zhèng  
 testify; give witness